



+

VIP 500 series

VIP 505 (KM-1510.3T) /VIP 515 (KM-1520.3T)



CE



ISO 9001



Read the map, all the way!

GENERAL WARNING

- DO maintain your chair well, in particular check the tire pressure since this affects the efficiency of the brakes.
- DO make sure both brakes are applied before getting in or out of the chair.
- DO make sure both brakes are applied when the chair is not being pushed or used.
- DO take care when climbing curbs or turning on slopes.
- DO avoid steep or uneven surfaces that may cause the chair to tip over.
- DO avoid soft surfaces because the casters may become bogged down.
- DO travel smoothly in all conditions.
- DO look well ahead to anticipate hazards such as furniture, doors, potholes, etc.
- DO make sure that both feet are safely on the footrests and that clothing is safely tucked out of the way so that it cannot get caught in the wheels.
- DO take care when traveling up or down or across inclines.
- DO keep both hands on the push handles to control the chair, if you are the attendant.
- DO pay attention to keep the chair balanced.
- DO check the frame and components regularly and refer to this user guide during and after the warranty period.
- DO tie-up the upholstery or replace which with a new one when it becomes loose.
- DO lubricate bearings regularly.
- DO equip with anti-tippers to avoid falling backwards.
- DO equip with a seat belt designed for disabled people.
- DO equip with "ankle supports" for disabled people.
- DO clean both hands after oiling the wheelchair.
- DO tighten the screws of headrest tubes.
- DO NOT overload the chair in any circumstance.
- DO NOT hang anything heavy on the back of the chair that could cause the chair to become unstable, particularly when negotiating inclines.
- DO NOT allow more than one user at a time.
- DO NOT use with an unconscious patient.
- DO NOT use other transport to pull the wheelchair.
- DO NOT do "wheelies", as you may fall or tip over backwards and suffer a severe injury.
- DO NOT sit in a wheelchair within a moving vehicle unless it has affixed the labels of hook mark.
- DO NOT go too fast or turn too quickly.
- DO NOT stand on the footplates when getting in or out of the chair.
- DO NOT go down steps forward, whether solo or with an attendant.
- DO NOT attempt to lift the wheelchair by any removable (detachable) parts.
- Lifting by means of any removable (detachable) parts of the wheelchair may result in injury to the user and/or assistant or damage to the wheelchair.
- DO NOT use the wheelchair when the back is folded. This alters the centre of gravity and may cause the wheelchair to tip backwards. The back should only be folded for storage or transport of the wheelchair.
- DO NOT hang anything on the back joint that could cause the backrest folding suddenly and may cause injury.

YOU AND YOUR KARMA SERVICE PROVIDER

- No tools are required for assembly. Your wheelchair should be assembled by your authorized Karma dealer. Your authorized Karma dealer is also your service provider. Unauthorized repairs, upgrades and add-ons will negate your warranty. Anything wheelchair related that requires tools should be done by your authorized Karma service provider. Your Karma service provider has the necessary service/maintenance owner's(manual) for your wheelchair.
- If you have any defective parts or lose any parts, please contact your dealer for repair and/or replacement. Please only use parts authorized by Karma. Use of parts that are not authorized by Karma will negate your warranty.
- Part numbers are listed on our bill of materials (explosion drawings), which we give to our authorized dealers and service providers. Customers should order parts through their dealer as well as all repairs and scheduled maintenance.
- Customers should go to their dealership for all service needs to guarantee their warranty is not nullified. Always go to an authorized service provider. Unauthorized repairs will nullify your warranty. Procedures other than those described in this owner's(manual) must be performed by a qualified technician. They also have the service owner's(manual) with a complete list of maintenance required to keep your Karma wheelchair in top performance. Check the warranty section of this owner's(manual) to find out what Karma guarantees and what maintenance and parts you will have to pay for.
- Karma does not have an official list of service providers at this time. Please contact your dealer for service. If you cannot contact your dealer, please contact another authorized Karma dealer for service. If all else fails, contact Karma directly via our website or give us a call and we can refer you to your new service provider.

CE MARKING

This wheelchair complies with the requirements of the Medical Devices Directive 93/42/EEC.



CAUTION:

Before purchasing and using Karma wheelchairs, please consult qualified professionals so as to ensure that you choose suitable products and use them correctly as well. For safety reasons, if there is any risk due to the user's movement in the wheelchair or other environmental factors that might cause the wheelchair to tip or the person on the wheelchair to fall off, Karma recommends that you install anti-tippers, safety belt, or other additional safety accessories.



TABLE OF CONTENTS

1. PREFACE	2
2. SAFETY.....	3
3. INTENDED USE & PARTS	7
3.2 Parts Description.....	8
4. OPERATION.....	9
5. INSPECTION AND MAINTENANCE	22
6. OPTIONS AND ACCESSARIES	25
7. TROUBLESHOOTING	26
8. SPECIFICATIONS	27
9. CLEANING & RECYCLING	28
10. WARRANTY	28

1. PREFACE

Please carefully read this owner's(manual) before using the wheelchair. Improper use of the wheelchair could result in harm or injury. Therefore, for safe and enjoyable use of the wheelchair, please read this owner's(manual).

- This owner's(manual) includes operation instructions for the aspects of the wheelchair, unfolding/folding instructions, and instructions on how to deal with possible accidents.
- This owner's(manual) is written for Karma wheelchair: VIP 500 series.
- The symbols used in this owner's(manual) are explained below. Pay special attention to the parts marked with these symbols.

	WARNING:	Improper use could lead to serious injury or death.
	CAUTION:	Improper use could lead to serious injury and/or damage to your wheelchair.
	SUGGESTION:	Follow these instructions to keep the wheelchair in good condition.

- This owner's(manual) includes the repair and maintenance chart as well as the warranty.
- If someone else uses the wheelchair, make sure that you give him or her this owner's(manual) for his or her reference.
- As designs change, some illustrations and pictures in this owner's(manual) may not correspond to the wheelchair that you purchased. We reserve the right to make design modifications without further notice.

2. SAFETY

2.1 Doorways

The safest way to operate the chair is on level floors that are free of obstacles. Whenever possible use a ramp to enter or exit a facility. Keeping your hands on the push rims will allow you to maintain maximum balance. Do not try to force yourself over an obstruction by propulsion and never use the sides of a doorway to pull yourself through a passageway.

2.2 Leaning

Do not lean over the side of your wheelchair since such an action may cause you to lose balance and fall. (See Figure 2.1)

2.3 Navigating Inclines

- Never turn on a hill due to the danger of tipping.
- When assisting, go straight up a slope. If user needs to go down midway, walk backwards until user is on level ground. (See Figures 2.2 and 2.3)
- Avoid stopping on an incline; it can potentially cause you to lose control of the chair.
- Do not use the brakes to slow down or stop the wheelchair; this could cause it to seize up, causing you to lose control or fall out of the chair.
- Whenever possible, utilize help from an assistant/attendant while navigating inclines.

2.4 Curbs

- Whenever possible get help from an assistant/attendant (if you have assistance make sure that your chair is equipped with push handles).
- Avoid hard impacts when descending a curb. A hard impact could adversely affect the chair.
- Never try to scale or descend curbs that exceed a normal height. (30-50cm)
- Always be careful when climbing curbs and never move up or down a curb in reverse without an assistant.

2.5 Stairs

- Always use two or more assistants.
- Never go down steps forwards.
- Never use an escalator for transport, use an elevator.

2.6 Streets

- Always use extreme caution when crossing streets. Reflective tape on the chair and/or your clothing will make you more visible to drivers.
- Avoid potholes and rough terrain that might cause the casters to become stuck.(See Figure 2.4)

2.7 General

- Always make sure BOTH brakes are applied before getting in or out of the chair.
- Never stand on the footplates when getting in or out of the chair.
- Never carry more than one passenger. Karma wheelchairs are limited to one user.

- Use caution to assure your clothing doesn't get tangled with the wheels.

2.8 Transport

- Do not use other transportation to pull the wheelchair.
- Do not get transported on any vehicle while seated in your wheelchair. Karma doesn't approve of any tie-down systems. Please transfer into seating approved by the automotive (or other) industry and wear a safety belt.

2.9 Upholstery

- When cleaning the upholstery, use warm water and a mild soap.
- Upholstery cleaner/foam can also be used, but avoid other cleaning solvents.

2.10 Anti-tippers

Please purchase anti-tippers and always use them to avoid personal injury.

 **CAUTION:**

When tilting your wheelchair, please change the position no.3 to avoid tipping and injury user. (see the bellow figures)



2.11 Maximum User Weight Limit

Refer to "Max. User Weight" in section 8. SPECIFICATIONS. Loads exceeding maximum capacity can damage your wheelchair and cause malfunctions yielding a safety hazard. The warranty does not cover damage caused by improper operation of the wheelchair.

2.12 Avoid General Misuse

- Please note that our "Owner's(Manual)" contains a number of cautions -- any vehicle can cause injury if misused -- use within our guidelines and with reasonable care and your safety will be increased. Your wheelchair will give years of safe use if used sensibly and carefully. Be aware that careless use endangers your own safety as well as that of others. ALWAYS follow the Highway Code when outdoors and the guidelines written in this owner's(manual).
- Do not let children stand or play on the wheelchair. (See Figure 2.5)



Figure 2.1



Figure 2.2



Figure 2.3



Figure 2.4



Figure 2.5

2.13 Labeling

Please carefully read all the labeling on the wheelchair before driving it. Do not remove them. Protect them for future reference.



1

2

3

Model:	
Order No.:	
Delivery Date:	
Serial No.: <input type="checkbox"/> 1 <input type="checkbox"/> 2 <input type="checkbox"/> 3 <input type="checkbox"/> 4 <input type="checkbox"/> 5 <input type="checkbox"/> 6	
Seat Width	Seat Depth
<input type="checkbox"/> 13	<input type="checkbox"/> 13
<input type="checkbox"/> 14	<input type="checkbox"/> 14
<input type="checkbox"/> 15	<input type="checkbox"/> 15
<input type="checkbox"/> 16	<input type="checkbox"/> 16
<input type="checkbox"/> 17	<input type="checkbox"/> 17
<input type="checkbox"/> 18	<input type="checkbox"/> 18
<input type="checkbox"/> 19	<input type="checkbox"/> 19
<input type="checkbox"/> 20	<input type="checkbox"/> 20
<input type="checkbox"/> 21	<input type="checkbox"/> 21
<input type="checkbox"/> 22	<input type="checkbox"/> 22
<input type="checkbox"/> 23	<input type="checkbox"/> 23
<input type="checkbox"/> 24	<input type="checkbox"/> 24
<input type="checkbox"/> 25	<input type="checkbox"/> 25
<input type="checkbox"/> 26	<input type="checkbox"/> 26
<input type="checkbox"/> 27	<input type="checkbox"/> 27
<input type="checkbox"/> 28	<input type="checkbox"/> 28
<input type="checkbox"/> 29	<input type="checkbox"/> 29
<input type="checkbox"/> 30	<input type="checkbox"/> 30
<input type="checkbox"/> 31	<input type="checkbox"/> 31
<input type="checkbox"/> 32	<input type="checkbox"/> 32
<input type="checkbox"/> 33	<input type="checkbox"/> 33
<input type="checkbox"/> 34	<input type="checkbox"/> 34
<input type="checkbox"/> 35	<input type="checkbox"/> 35
<input type="checkbox"/> 36	<input type="checkbox"/> 36
<input type="checkbox"/> 37	<input type="checkbox"/> 37
<input type="checkbox"/> 38	<input type="checkbox"/> 38
<input type="checkbox"/> 39	<input type="checkbox"/> 39
<input type="checkbox"/> 40	<input type="checkbox"/> 40
<input type="checkbox"/> 41	<input type="checkbox"/> 41
<input type="checkbox"/> 42	<input type="checkbox"/> 42
<input type="checkbox"/> 43	<input type="checkbox"/> 43
<input type="checkbox"/> 44	<input type="checkbox"/> 44
<input type="checkbox"/> 45	<input type="checkbox"/> 45
<input type="checkbox"/> 46	<input type="checkbox"/> 46
<input type="checkbox"/> 47	<input type="checkbox"/> 47
<input type="checkbox"/> 48	<input type="checkbox"/> 48
<input type="checkbox"/> 49	<input type="checkbox"/> 49
<input type="checkbox"/> 50	<input type="checkbox"/> 50
<input type="checkbox"/> 51	<input type="checkbox"/> 51
<input type="checkbox"/> 52	<input type="checkbox"/> 52
<input type="checkbox"/> 53	<input type="checkbox"/> 53
<input type="checkbox"/> 54	<input type="checkbox"/> 54
<input type="checkbox"/> 55	<input type="checkbox"/> 55
<input type="checkbox"/> 56	<input type="checkbox"/> 56
<input type="checkbox"/> 57	<input type="checkbox"/> 57
<input type="checkbox"/> 58	<input type="checkbox"/> 58
<input type="checkbox"/> 59	<input type="checkbox"/> 59
<input type="checkbox"/> 60	<input type="checkbox"/> 60
<input type="checkbox"/> 61	<input type="checkbox"/> 61
<input type="checkbox"/> 62	<input type="checkbox"/> 62
<input type="checkbox"/> 63	<input type="checkbox"/> 63
<input type="checkbox"/> 64	<input type="checkbox"/> 64
<input type="checkbox"/> 65	<input type="checkbox"/> 65
<input type="checkbox"/> 66	<input type="checkbox"/> 66
<input type="checkbox"/> 67	<input type="checkbox"/> 67
<input type="checkbox"/> 68	<input type="checkbox"/> 68
<input type="checkbox"/> 69	<input type="checkbox"/> 69
<input type="checkbox"/> 70	<input type="checkbox"/> 70
<input type="checkbox"/> 71	<input type="checkbox"/> 71
<input type="checkbox"/> 72	<input type="checkbox"/> 72
<input type="checkbox"/> 73	<input type="checkbox"/> 73
<input type="checkbox"/> 74	<input type="checkbox"/> 74
<input type="checkbox"/> 75	<input type="checkbox"/> 75
<input type="checkbox"/> 76	<input type="checkbox"/> 76
<input type="checkbox"/> 77	<input type="checkbox"/> 77
<input type="checkbox"/> 78	<input type="checkbox"/> 78
<input type="checkbox"/> 79	<input type="checkbox"/> 79
<input type="checkbox"/> 80	<input type="checkbox"/> 80
<input type="checkbox"/> 81	<input type="checkbox"/> 81
<input type="checkbox"/> 82	<input type="checkbox"/> 82
<input type="checkbox"/> 83	<input type="checkbox"/> 83
<input type="checkbox"/> 84	<input type="checkbox"/> 84
<input type="checkbox"/> 85	<input type="checkbox"/> 85
<input type="checkbox"/> 86	<input type="checkbox"/> 86
<input type="checkbox"/> 87	<input type="checkbox"/> 87
<input type="checkbox"/> 88	<input type="checkbox"/> 88
<input type="checkbox"/> 89	<input type="checkbox"/> 89
<input type="checkbox"/> 90	<input type="checkbox"/> 90
<input type="checkbox"/> 91	<input type="checkbox"/> 91
<input type="checkbox"/> 92	<input type="checkbox"/> 92
<input type="checkbox"/> 93	<input type="checkbox"/> 93
<input type="checkbox"/> 94	<input type="checkbox"/> 94
<input type="checkbox"/> 95	<input type="checkbox"/> 95
<input type="checkbox"/> 96	<input type="checkbox"/> 96
<input type="checkbox"/> 97	<input type="checkbox"/> 97
<input type="checkbox"/> 98	<input type="checkbox"/> 98
<input type="checkbox"/> 99	<input type="checkbox"/> 99
<input type="checkbox"/> 100	<input type="checkbox"/> 100

3. INTENDED USE & PARTS

3.1 Intended Use

- The VIP 500 series is a self-propelled or transit wheelchair. That is, it can either be propelled by an attendant(transit) or by the user(self-propelled)
- These wheelchairs are suitable for users up to 253lb in weight. Hand brakes are provided for both rear wheels and are connected to a dual attendant brake located on the left push handle.
- It has an extremely durable aluminum alloy frame with tough accessories and does not suffer in dramatic extremes of temperature (neither user nor attendant need touch metal parts in normal use).
- This chair is designed for both indoor and outdoor use.
- The casters have solid tires for greater durability; pneumatic casters are available on request.
- Rear wheels are 20 inches in diameter and solid PU tires are available on request.
- When prescribing wheelchairs for use by full or partial amputees (above or below knee, single or double) or other conditions that affects the users natural center of gravity, we suggest contacting your therapist or dealer as well as attaching anti-tippers.
- Intelligent 0-35° center-of-gravity weight-shifting tilt-in-space seat shifts pressure to reduce bedsores, while providing wheelchair users a wide choice of tilt-in-space angles with increased balance and stability.
- Lightweight foldable design allows easy transport.
- The gas cylinders give attendant to tilt user more easily

3.2 Parts Description

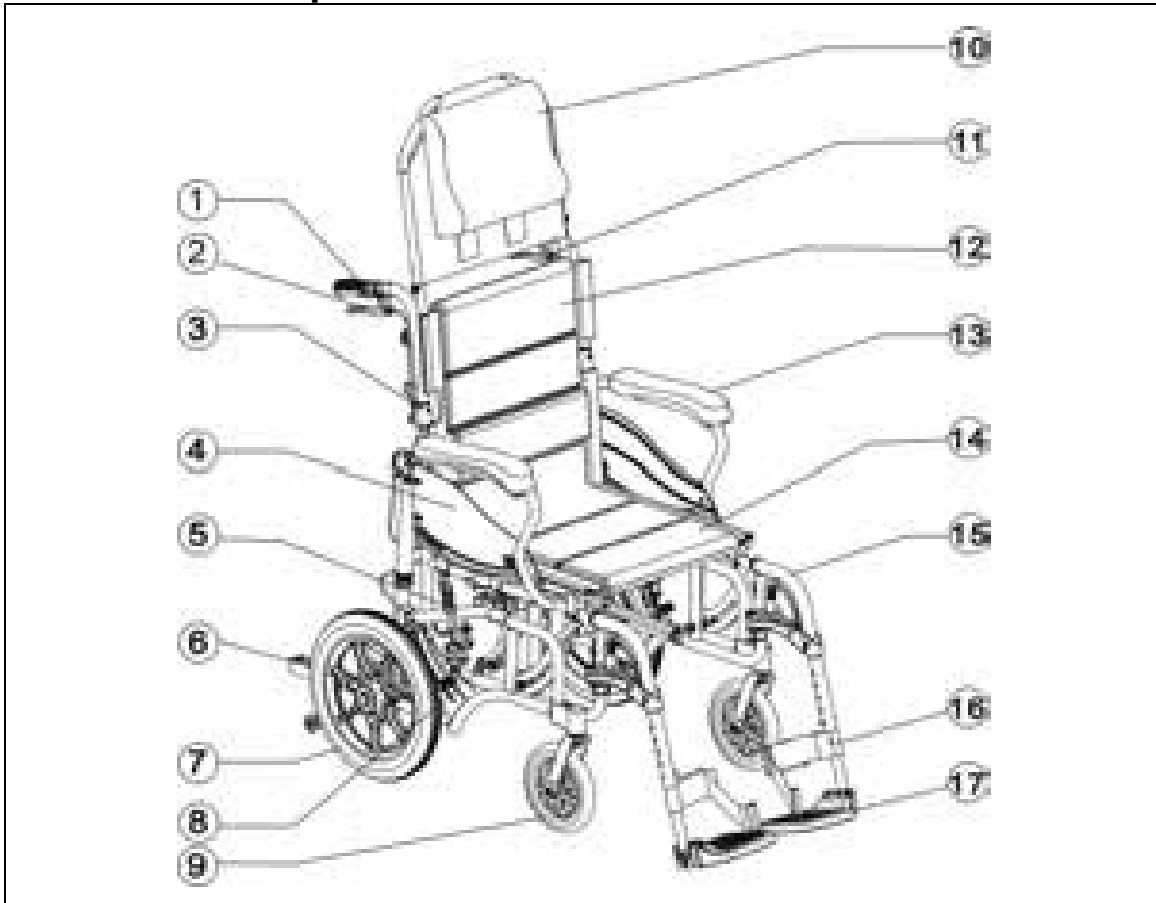

<ul style="list-style-type: none">1. Push Handle2. Release lever3. Back joint4. Side Panel5. Brake6. Anti-tippers7. Rear Wheel8. Cross Brace (Cross Bar)9. Caster	<ul style="list-style-type: none">10. Headrest Upholstery11. Attendant brake12. Back Upholstery13. Armrest14. Seat Upholstery15. Footrest16. Heel Loop17. Footplate
---	--

4. OPERATION

4.1 Preparing For Use

4.1.1 Unfolding

- Holding the armrests, pull outwards. (See Figure 4.1)
- Pointing your fingers inward with the palm of your hand on the frame, push down until the seat is fully lowered. Make sure the frame is firmly seated in its holder. (See Figure 4.2)
- Holding the swing-away footrest, lower it into its coupling at 45° from the side. Swing the footrest towards the middle until you hear it click into place. (See Figure 4.3)
- Flip the footplates down. (See Figure 4.4)
- Attach the headrest and tighten the knob bolts. (See Figure 4.5)
- Ready for action!



CAUTION:

- Please be sure to tighten the knob bolts of the headrest or else it might result in injury to the user or damage to the wheelchair.

Alternatively, you can stand at the side of the chair and complete step 1 by pulling the nearest armrest towards you and pushing the other one away.



Figure 4.1



Figure 4.2



Figure 4.3



Figure 4.4



Figure 4.5



CAUTION:

Be careful not to get your fingers caught when folding the wheelchair.



CAUTION:

When completing step 2 never put your fingers around the sides or under the chair as they can be trapped between the seat and the frame. (See Figure 4.6)

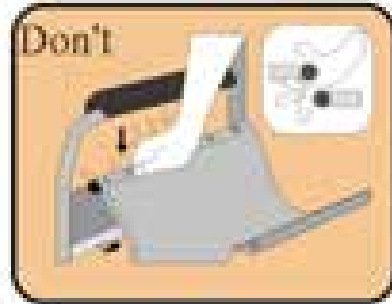

Figure 4.6

4.1.2 Folding

- Remove the headrest. (See Figure 4.7)
- Flip up the footplates. (See Figure 4.8)
- Squeeze the swing-away footrest release handle and rotate the footrest to either side for removing. (See Figure 4.9)
- Pull up on the seat upholstery by holding it in the center of its front and back edge. (See Figure 4.10)
- Press the two release levers on the backrest frame (push handle tubes) to fold the backrest down for compact storage and easy transport. (See Figure 4.11)
- Folding is now completed.



Figure 4.7



Figure 4.8



Figure 4.9



Figure 4.10



Figure 4.11

4.2 Adjustments

4.2.1 Footrest

- Footrests can rotate in or out, which makes transferring in tight spaces easier. Swinging both footrests inward makes it easier to work at a desk. (See Figures 4.12 and 4.13)
- To adjust footplate height use the Karma tool provided to loosen the bolt at the side of the footrest arm.
- Adjust it to the desired height, re-tighten the screw and make sure the footplate is firm. Then tighten the nut as a locknut from outside. (See Figure 4.14)

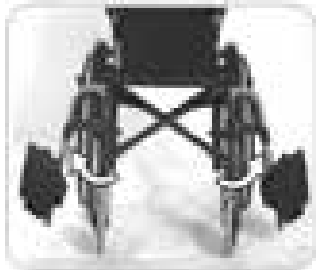

Figure 4.12



Figure 4.13



Figure 4.14



Figure 4.15



SUGGESTION:

- Make sure that the footplate height is adjusted properly according to the users calf length to reduce pressure on the body.
- The footrest height must be more than 5cm. (See Figure 4.15)

4.2.2 Footrest

- Squeeze the swing-away footrest release handle and rotate the footrest to either side for removing. (See Figure 4.16)



Figure 4.16

4.2.3 Headrest

- Your headrest height may be adjusted to a suitable position for you. Simply attach or detach the headrest using the hook and loop fabric. (See Figure 4.17)



Figure 4.17

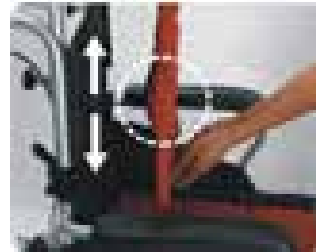

Figure 4.18



SUGGESTION:

- Before using, please attach the headrest and tighten the screws.

4.2.4 Back Upholstery

- There is a thicker part in the middle of backrest upholstery. It is designed to support the lower lumbar of your back. Please adjust it to fit you and attach it on the backrest using the hook and loop fabric. (See Figure 4.18)

4.2.5 Tilting Your Wheelchair 0-35°

- Please lock both brakes. (See Figure 4.21)
- Grasp the right push handle and squeeze the tilt lever. (See Figure 4.22)
- Press downward with both hands simultaneously until the desired seat angle is achieved and then release the lever. (See Figure 4.23)



Figure 4.19



Figure 4.20



Figure 4.21

4.2.6 Flip-back armrest (for VIP 515)

Armrest flips back by pressing the release lever located at the front base of the armrest. After you press the release lever, you can lift and rotate the armrest backwards. (See Figures 4.22 and 4.23)

The height adjustment : Simply loosen and remove the knob bolt, then adjust the armrest to the desired height and finally reattach the knob bolt.

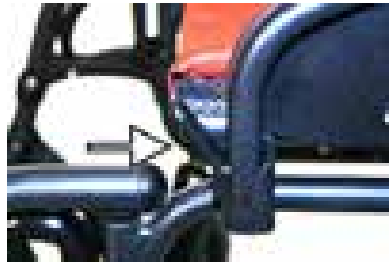

Figure 4.22



Figure 4.23

4.2.7 Transporting and Storing

Make sure the wheelchair is folded when stored.



SUGGESTION:

Please store the wheelchair in a location where it is out of direct sunlight, rain and dew. For more details, consult your Karma dealer.



WARNING:

Don't put anything on the wheelchair while it is in storage. Storing goods on a folded wheelchair will cause damage and is not covered under warranty. (See Figure 4.24)



Figure 4.24

4.3 Transferring In and Out

4.3.1 Transferring In

- Engage both hand brakes.
- Turn the footplates up and swing them to the side.
- The user lowers himself/herself into the seat using the armrests for support.
- Turn the footplates back down, so that the user can place his feet on them.
- Release both hand brakes.



Caution:

Always ensure that the front casters are in line with the rear wheels and pointing forwards and that the back of the chair is secure either against a wall or firmly held by an attendant.

4.3.2 Transferring Out

- Make sure that the chair is near your final destination.
- Back the chair sufficiently to ensure that the casters are pointing forward, i.e. in line with the rear wheels and usually with the caster forks pointing forward. Ensure that, where possible, the rear of the chair is against a wall or, if not, it must be firmly held by an attendant.

- Engage both hand brakes.
- Turn the footplates up and swing them to the side.
- Slide forwards on the seat.
- Place one foot firmly on the ground with the knee at a right angle and the other foot slightly apart and further back.
- Place your hands on the front of the armrests and moving your weight forward, bring your head and shoulders up over your knees as you push yourself up.



Caution:

- Never stand on the footplates when getting into (or out of) the chair. (See Figure 4.25)
- When getting in and out of the wheelchair please use the hand brakes. The hand brake is the lever at the side of the wheelchair.
- Please ensure that neither the tread on your tires nor the brake block has become too worn. If pneumatic tires are fitted, please maintain at the recommended tire pressure for the same reason.
- Please ensure that occupant's fingers do not get caught in the brake.

When transferring in and out of the chair, make sure that the brakes are applied to prevent the chair from sliding away. Also see that the footplates are flipped up for ease of entering or exiting. (See Figure 4.26)

4.4 General Use

4.4.1 Attendant Pushing and Self-propelled

- Do ensure that the brakes are always locked when the chair is not being pushed. (See Figure 4.27)
- Always make sure that both feet are safely on the footplates and that clothing is safely tucked out of the way and cannot get caught in the wheels. (See Figure 4.28)
- Always use both hands on the push handles to control the chair. (See Figure 4.29)
- Always avoid steep or uneven surfaces because the chair may tip over. (See Figure 4.30)
- Always avoid soft surfaces because the casters may get bogged down. (See Figure 4.31)
- Always be careful not to go too fast or turn too quickly and try to achieve a smooth steady ride.
- Before crossing the tracks, please stop completely and look both ways.
- Cross the tracks perpendicular to avoid your wheels getting stuck.
- Do not drive at full speed over railroad tracks.
- Be careful going through a doorway that your hands and arms do not get injured.

PLEASE keep in contact with the person in the chair. If you stop to look in shop windows or talk to people, remember to turn the chair so that the person in the chair does not have to turn.



WARNING:

NEVER lock the brakes too suddenly as this may tip the user out of the chair.



Figure 4.25



Figure 4.26



Figure 4.27



Figure 4.28



Figure 4.29



Figure 4.30



Figure 4.31



Figure 4.32

4.4.2 Tilting by the Attendant

- Make sure both the user's feet are on the footplates and will not slip off. Make sure the handgrips are secure and cannot slip off.
- Release both brakes.
- Grasp both push handles firmly.
- Put your stronger foot on the relevant tipping lever at the back of the chair.
- Tell the person in the chair that you are about to tilt the chair backwards.
- Pull back with both hands and push down and forwards with the foot. This will bring the chair onto the back wheels. (See Figure 4.32)



Caution:

- When a chair is tilted to about 25 degrees it will balance on its rear wheels and be easy to hold. If it is tilted further back it will be difficult to hold and the person in the chair will feel unsafe.
- Lower with a straight back; keep your foot on the anti-tipper and lower the chair slowly forwards softly to the ground.

4.4.3 Tilting by the User

- Make sure your feet are on the footplates and will not slip off.
- Release both brakes.
- Grasp both push rims and give a firm, sudden forward push immediately before the obstacle, continue the momentum (be ready to keep pushing) until the obstacle is mounted.

**Caution:**

- This method should only be attempted by people experienced in wheelchair use. Strong arms are also necessary. It is always better to have the help of an attendant.
- Leaning backwards causes the casters to rise higher BUT it is much safer to lean forwards and stay balanced.

4.4.4 Going Down Curbs

Please note: It is always better to avoid curbs where possible by using ramped curbs or slopes and this operation is best attempted with the aid of an attendant.

4.4.4.1 Going Down Curbs Forwards with and Attendant

**Caution:**

- This is the more difficult method and can jar the user but allows a better view of traffic.
- Be careful that the anti-tipper does not get caught on the curb causing the user to fall.

NEVER ALLOW THE CHAIR TO TIP FORWARDS WHEN GOING DOWN A CURB.

- Position the chair so that the front casters are near the edge of the curb and make sure that the road is clear.
- Move the chair slowly and carefully forwards while tilting it back slightly. Be ready to take the weight when the rear wheels cross the curb edge. Ensure that both rear wheels touch the ground at the same time to avoid tipping the chair.
- Gently lower the front casters. AVOID JARRING THE USER.

4.4.4.2 Going Down Curbs Backwards with an Attendant

**Caution**

This is the easier and smoother method BUT it requires the attendant to step backwards into the road.

- Back the chair to the curb edge and be careful that the back wheels are equally near the edge.
- Grasping the push handles, gently lower the rear wheels onto the road. Be prepared to control the weight as it descends and ensure that the back wheels touch ground at the same time.
- Tilt the chair back slightly and pull the tilted chair far enough into the road so that the casters and footrests can be lowered clear of the curb.

4.4.5 Going Up Curbs

Please note: This operation is best attempted with the aid of an attendant and the best method is to go up curbs forwards as this maintains the direction of travel and is physically less demanding for the attendant.

4.4.5.1 Going Up Curbs Forwards with an Attendant

- As the footrests nearly touch the curb tilt the chair. The chair should be tilted just high enough to allow the front casters to roll smoothly onto the pavement.
- Push the chair forward until the rear wheels are touching the curb. Then, continuing the movement, lift at the push handles while moving the chair forwards.

4.4.5.2 Going Up Curbs Backwards with an Attendant

Please note: for safety's sake we do not recommend using this method.

4.4.6 Up and Down Steps/Stairs

Please note: avoid flights of steps particularly if no extra help is available. Use ramps or lifts wherever possible.

Two attendants are necessary, each capable of carrying at least half of the combined weight of the person and the wheelchair.

Each helper should bend at the knees and grip the main frame: with the front attendants hands just under the front of the seat, with the back attendants hands holding the frame just under the push handles.



Caution:

Don't attempt to lift the wheelchair by any removable (detachable) parts. Lifting by means of any removable (detachable) parts of wheelchair may result in injury to the user and/or assistant or damage to the wheelchair.

ALL LIFTING SHOULD BE DONE WITH A STRAIGHT BACK.

Straighten legs to lift the chair. Carefully carry it up or down steps; be aware of how you place your feet -- do not cross them and trip yourself up.

4.5 Transportation

The VIP-505 has been crash tested to ISO7176 and is suitable for use in a vehicle that has been adapted for this purpose. The wheelchair must be securely restrained as described in this manual. The VIP was tested with a four pint webbing system. For further information on the use of wheelchair restraints please refer to the manufacturer's user guide.

Karma always recommends that the user be transferred into car seat with a safety belt or harness while in a transport.



SUGGESTION:

Please transfer to a seat in the car if at all possible

4.5.1 Before use



CAUTION:

The VIP-505 was tested with a four point webbing system, with the back in the upright position. Please leave the headrest in place during transportation.

- Please detach all easily removable accessories from the wheel-chair and stow them in a safe place where they cannot move around and become a safety hazard.
- A four point tie-down system should tightly fasten to the lower wheelchair frame



marked with a yellow sticker as pictured.

- An occupant restraint system using both a pelvis and harness must also be fastened to the transport vehicle to insure user safety. Please refer to the restraint system's instructions.
- The attendant / transporter must double-check all fastening points for proper connection and tightness to assure the wheelchair users safety. The attendant / transporter must be fully cognisant of the fastening system's usage and its weight limitations.
- See <http://www.unwin-safety.com/> for more information.

4.5.2 Method of restraint

The VIP-505 was tested with four point webbing systems, with the back in the upright position. Please refer to the restraint manufacturer's user guide for further details of its operation.

Fitting the front restraint

- Connect the straps around the wheelchair frame and caster bracket as pictured below. The anchor point is marked with a yellow sticker.
- Take the brakes off and reverse the wheelchair to tension the front straps. Apply wheelchair brakes (the brakes should be left on during transport)

Fitting the rear restraint

- Attach rear straps into rail approximately 11.8 in behind the wheelchair backrest.
- Attached the hooks to the wheelchair brackets at the rear of the wheelchair as pictured below. Tension the restraint until the wheelchair is secure.



Fitting the front restraint



Fitting the rear restraint

Fitting seat belt

- Fasten the 3 point safety belt around the user.
- The occupied wheelchair should be located in a forward-facing configuration, with the parking brake applied.

- Pelvic restraints should make full contact across the front of the body near the junction of the thigh and pelvic as pictured below (correct seat belt position).
- Restraints should not be held away from body by wheelchair components such as armrest or wheels as pictured below (Incorrect seat belt position).

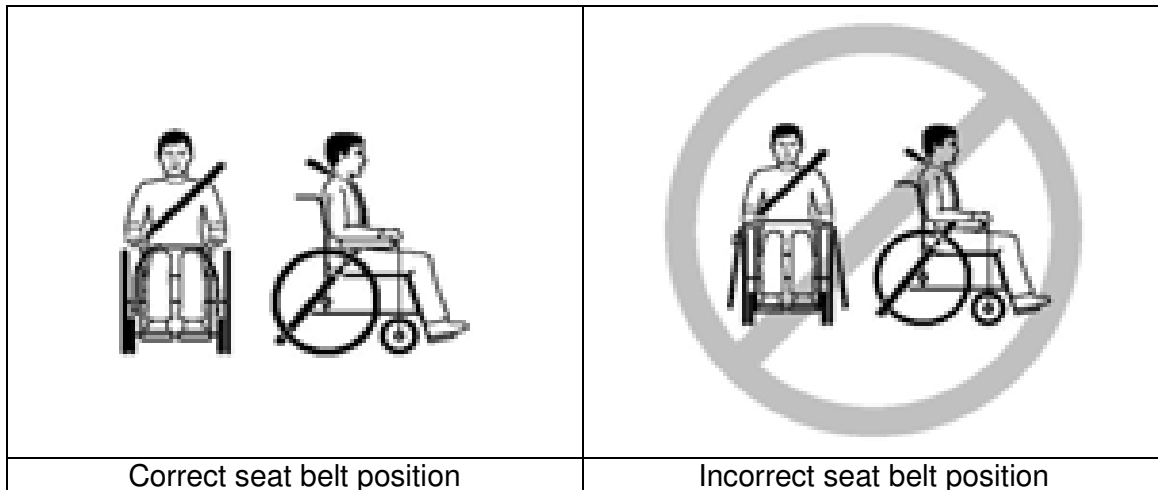

4.6 Safety Belt

How to assemble and disassemble the Safety Belt

- Loosen the fourth and fifth screws of both side of seat upholstery and insert the Safety Belt in between the fourth and fifth screw holes. (Figure 4.33)
- Keep the safety Belt in 45 deg for comfortable usage. (Figure 4.34)
- Put the seat upholstery back and tighten screws.

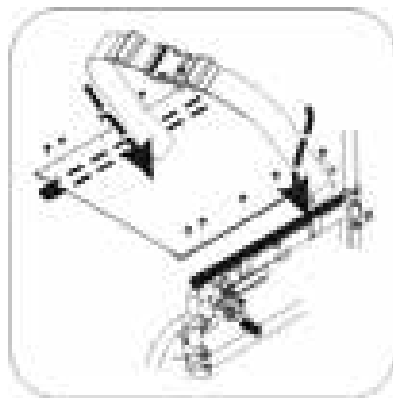

Figure 4.33

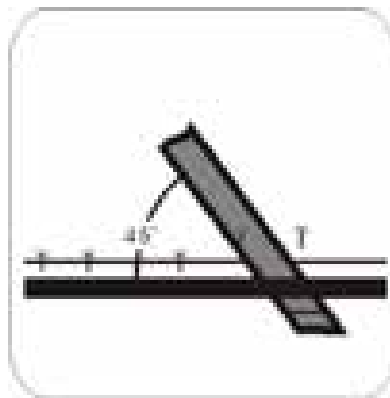

Figure 4.34

Adjusting length of seat belt

- Identify the require length of the belt. (Figure 4.35)
- Push the two part of belt through buckle to make the belt longer or shorter. (Figure 4.36)
- Pull the two part of belt tight. (Figure 4.37)
- Push buckle up to the plastic clip so that the belt can not slip out of position. Please check that there is no gap between the clip and buckle. (Figure 4.38)



SUGGESTION:

We recommend that the belt is fitted quite tightly around the pelvis. Please tighten until you can just get your fingers between user and seat belt. Please check that the belt is fastened correctly as recommended. If this is not possible please consult your supplier.



Figure 4.35



Figure 4.36



Figure 4.37



Figure 4.38

How to operate it:

- When you sit on the wheelchair, fasten the safety belt.
- Adjust the belt and make it fit your body for comfort and security.
- When you don't use it, please fasten the belt to avoid the belt dropping into rear wheels during motion.

Maintenance

The Safety Belt is made from 100% polyester fibre and the clasp is made from plastic. It does not require any maintenance but should be inspected every month to ensure that the edges are not frayed and weekly to make sure that it correctly fits the user. If there are any signs of deterioration, please replace it immediately.

5. INSPECTION AND MAINTENANCE

5.1 Daily Check

Check the following items before traveling. If you find anything abnormal, visit your Karma wheelchair dealer for further inspection before using it.

- Examine brakes, checking for wear, damage and misalignment. Replacing or adjusting the brakes should be carried out by your approved repairer.
- Check that the hand grips are not damaged and are securely bonded to the push handles.
- Check anti-tippers are not damaged and are securely attached.
- Check that the anti-tippers' wheels and frame are not damaged and are securely mounted.
- Check that the headrest screws are tightened.
- Before using the wheelchair, make sure all nuts and bolts are tight. Check all parts for damage or wear and have a qualified technician replace it if necessary. Check all parts for proper adjustment.
- Inspect brakes for proper operation.
- The wheels and tires should be checked periodically for cracks and wear, and should be replaced by a qualified technician.
- A qualified technician can be found with an authorized distributor/dealer.



CAUTION:

Visit a Karma wheelchair dealer for inspection and maintenance if you find anything abnormal.

5.2 Regular Maintenance Record

To make sure your wheelchair is in good condition, visit your Karma wheelchair dealer regularly for maintenance (and keep records accordingly) every six months after purchasing.

A maintenance/service fee may apply.



SUGGESTION:

Even if you don't use the vehicle for a long time, the wheelchair should still be maintained regularly. You should clean your wheelchair regularly to keep it beautiful and safe.

Item	Weekly	Monthly
GENERAL		
● Wheelchair rolls straight (no excessive drag or pull to one side)		V
FRAME AND CROSS BARS		
● Inspect frame structure for small cracks/fissures		V
● Inspect for bent frame or cross bars		V
BRAKES		
● Do not interfere with tires when rolling		V

● Pivot points free of wear and looseness		V
● Easy to engage	V	
● Prevent chair from moving when engaged	V	
HEADREST, SEAT & BACKREST		
● Inspect for rips or sagging	V	
● Inspect for loose or broken hardware		V
CASTERS		
● Inspect the casters for smooth rotation of the caster wheel and caster assembly		V
● Inspect the caster for wear in the bearings/mountings and for tire wear or damage		V
REAR WHEELS		
● Quick-release axles lock properly; lubricate if necessary	V	
● No excessive side movement or binding when lifted and spun		V
● Inspect for cracked, bent or broken spokes	V	
ARMRESTS		
● Inspect the detachable armrest button for effective locking		V
● Make sure the armrest detaches and flips back properly		V
FOOTRESTS		
● Inspect the footplate height adjustment screws are securely tightened		V
● Inspect the swing-away footrest release lever for effective locking		V
TIRES		
● Inspect for flat spots, cracks and wear	V	
● If pneumatic tires, check for proper inflation	V	
● Check tire tread depth is more than 1mm		V
● Check tire pressure; tire pressures are located on the side of the tire	V	
 CAUTION: As with any wheelchair, the wheels and tires should be checked periodically for cracks and wear, and should be replaced. Failure to keep tires at the correct pressure will reduce the braking efficiency.		

CAUTION:
Never disassemble or modify the wheelchair frame structure. Otherwise, injury or damage may occur. This will negate the warranty.

6. OPTIONS AND ACCESSORIES

	
<p>■ I.V. Pole</p> <ul style="list-style-type: none"> • Height adjusts from 130cm (51") to 200cm (78"). • Attaches to all Karma owner's(manual) wheelchairs. 	<p>■ Oxygen Holder</p> <ul style="list-style-type: none"> • Standard size attaches to the back of wheelchairs. • Attaches to all Karma owner's(manual) wheelchairs.
	
<p>■ Backrest Bag</p> <ul style="list-style-type: none"> • Standard size. • Attaches to all Karma owner's(manual) wheelchairs. 	<p>■ Folding Drink Holder</p> <ul style="list-style-type: none"> • Collapses and adjusts to the size of the container (6-10cm). • Attaches to all Karma owner's(manual) wheelchairs.
	
<p>■ Multi-purpose Safety Belt</p> <ul style="list-style-type: none"> • Attaches to all Karma owner's(manual) wheelchairs. 	

**CAUTION:**

Attaching accessories may alter the overall stability and center-of-gravity of the chair. Thus, this should be performed by your approved repairer and therapist.

7. TROUBLESHOOTING

Trouble or Problems with Your Wheelchair

You can inspect the following before taking your wheelchair to a Karma wheelchair dealer.

Problem	Checking Points and Corrective Action
Chair Veers Right/Left	<ul style="list-style-type: none">• Check tires for correct and equal pressure• Check caster bracket angle• Check that rear wheels are equally spaced from the seat frame
2. Sluggish Turn or Performance	<ul style="list-style-type: none">• Check tires for correct and equal pressure• Check for loose nuts and bolts
3. Caster Flutter/Wobble	<ul style="list-style-type: none">• Check tires for correct and equal pressure• Check for loose nuts and bolts• Check caster bracket angle
4. Squeaks and Rattles	<ul style="list-style-type: none">• Check for loose nuts and bolts
5. Looseness in Chair	<ul style="list-style-type: none">• Check for loose nuts and bolts

If you cannot solve the problem by yourself, contact your Karma wheelchair dealer for help.

8. SPECIFICATIONS

Model	VIP 500-F20	VIP 500-F14
Overall Length (in)	40.6 ~ 42.1	
Overall Width (in)	27.6	26.8
Overall Height (in)	55.3	
Total Weight (lb)	38.6	
Seat Width (in)	18	
Seat Depth (in)	17	
Seat Height (in)	19.5	
Backrest Height (in)	17.5	
Armrest Height (in)	8.7	
Calf Length (in)	14.6 ~ 17.5	
Overall Collapsed Length (in)	32.3	30.3
Overall Collapsed Width (in)	14.6	13.4
Overall Collapsed Height (in)	30.3	30.3
Maximum User Weight (lb)	253	253

Stability (According to ISO 7176-1:1999)

Forward Min. 16 degrees

Backward Min. 16 degrees

Sideways Min. 13 degrees

- The degree tolerance is +0, -1 degree.
- The test condition: size of test dummy used 253lb.
- Please don't travel across a slope (in any direction) greater than 7 degrees.

9. CLEANING & RECYCLING

9.1 CLEANING

In order to lengthen the life of your wheelchair, it is suggested that you clean the wheelchair periodically (if not daily), especially after it is used in the rain or snow. We suggest that you don't use your wheelchair in the rain or snow. If you are traveling and get caught in the rain, we suggest you try to find shelter while waiting it out. If you can't find shelter, proceed to your destination.

9.1.1 Frame

Wipe with a damp cloth.

9.1.2 Upholstery

- When cleaning the upholstery, use warm water and a mild soap.
- Upholstery cleaner/foam can also be used, but avoid other cleaning solvents.

9.2 POST-CONSUMER RECYCLING

A post-consumer recycling plan should follow the Environmental Protection Administration's regulations. The items listed below are for reference only as local laws and regulations may vary.

Material	Part Name	Method
Aluminum-alloy	Frame	Recyclable
Plastic	Modular Components	Recyclable
Paper	Owner's Owner's(Manual)	Recyclable

- There are many organizations in many countries you can find on the Internet that will accept used goods for charity. Please search the information highway to help less fortunate individuals and protect our planet for future generations. If you do not have access to the world wide web please use your local phone directory, ask for operator assistance or go to your local government center for more information. Earth Day is every day.
- Check with your local recycling center on where and how to recycle your wheelchair as this information varies from region to region.

10. WARRANTY

10.1 Serial Number

To ensure after-sale service and warranty, please record and fill in the serial number which can be found on the frame.

Model	VIP-515
Serial Number	

10.2 U.S.A. Limited Warranty Policy

Karman warrants the main frame of S-ERGO 105, 106, 115, 305, KM-3520, KM-802, KM-5000, KM-7501, KM-8020, VIP515, MVP-502 against defects in material and workmanship for the lifetime from the date of purchase, 6 months on parts.

Karman warrants the main frame of KM-9020L, KM-TV10, KM-AA10, KM-AA20 against defects in material and workmanship for one year from the date of purchase, 6 months on parts.

This warranty is extended only to original purchasers of our products. Warranty is NOT TRANSFERABLE. Parts or materials which are subject to normal wear and which must be replaced/repared are the owner's responsibility and are not covered by warranty. Arm pads and upholsteries are not covered by warranty. It is recommended that wheelchair be returned to the authorized dealer through whom it was original purchased.

If within such warranty period, any such product is proven to Karman's satisfaction to be defective, such product shall be repaired or replaced at Karman option. In no case are goods to be returned without first obtaining an R.M.A. (Returned Merchandise Authorization) number issued by Karman and that the part in question is returned insured with freight prepaid to Karman, within the period of warranty. Labor charge incurred in the installation or repair of the above-mentioned parts plus all freight charges are not included in the warranty.

If Karman does not have a completed Warranty Registration Card on file for the consumer's product, then a copy of the invoice with date of purchase must be provided. The warranty period for the consumer commences on the purchase date from the seller. The warranty period for the seller, if the products are not to be sold to a consumer, commences on the invoice date from Karman Healthcare. The warranty is void on wheelchairs that have had the serial # tag removed or altered.

Products which have been subject to negligence, abuse, improper storage or handling, improper operation, unauthorized modifications or misuse are not covered by this warranty. Karman Healthcare will not warrant the frame or any parts damaged when the maximum weight limit is exceeded. Warranty applies in the U.S. only.

Karman Healthcare's sole liability extends to repair or replacement of parts or components as previously specified. The foregoing is in lieu of all warranties expressed, implied or statutory, whether written or oral.