

FST-300 Free Standing Track

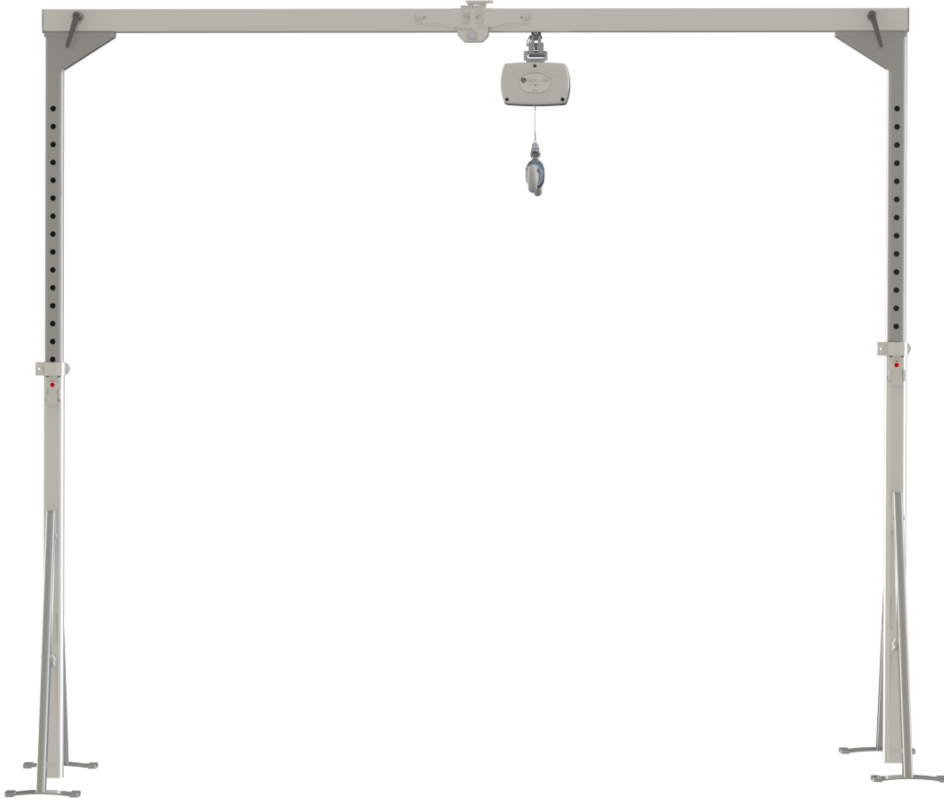

Introduction	2
Overview	2
General Placement.....	3
Components of System	4
Specifications	5
Requirements and Cautions	6
Assembly	
Assembling the Supporting Post	9
Trolley Installation	11
Track Assembly	12
Mounting: Track	13
Mounting: C-300	17
Mounting: P-300	18
Raising the Free Standing Track System	19
Attaching Skirt Accessory	22
Disassembly	
Disassembly of Free Standing Track.....	23
Disassembly of Legs.....	26
Trolley Disassembly.....	27
Troubleshooting	29
General Inspection and Maintenance	31
Service Record History	32
Warranty.....	36

Owner's Manual

Use and Care

Troubleshooting

Warranty





CAUTION: DO NOT ATTEMPT TO USE THIS EQUIPMENT WITHOUT FIRST UNDERSTANDING THE CONTENTS OF THIS MANUAL.

Introduction

Before using this equipment, and to ensure the safe operation of your Free Standing Track system, carefully read this entire manual, especially the section on “**Cautions.**” The Free Standing Track system is designed to be used in conjunction with Handicare portable lift units, accessories and slings. Please refer to any user guides supplied with these components and reference them while reviewing this manual.

Should any questions arise from reviewing this manual contact your local authorised Handicare dealer. Failure to comply with warnings in this manual may result in injury to the operator, or the individual being lifted/transferred. Damage to the lift and/or related components may occur. Be sure that the contents of this manual are completely understood prior to using this piece of equipment.

Store this manual with the documents included with the lift system and sling(s). Contents of this manual are subject to change without prior written notice.

Overview of the Free Standing Track System

The Free Standing Track system is a lifting aid to help lift, position and transfer clients or a disabled family member. The Free Standing Track system is part of what is termed overhead lift technology which takes advantage of lifting from above and not from below or the side. The Free Standing Track system makes it possible to move mobility impaired individuals with minimal strain or risk to the caregiver, while providing complete safety, dignity and comfort for the client or family member.

The Free Standing Track system is designed to work with a Handicare lift system such as the P/C-300 (Free Standing Track Maximum Safe Working Load is 300lb / 136kg). Contact your local authorised Handicare dealer to verify compatibility with other portable lift units.

The Free Standing Track system is a floor based free standing system that can be used to lift and transfer individuals from a bed, chair or similar fixture. It needs basic level of expertise to assemble or setup. It is easy to assemble and can be completed by just one person in a short period of time. Additionally, no tools are required. It is also light weight and once dismantled, can be moved to another location. Its quick setup (less than 5 minutes) and lightweight assemblies allows the caregiver to transport and transfer the client with minimum effort.

Please review the following pages that outline the parts included with your package. Should you have any questions about this product or its use, contact your local authorised dealer.

General Placement



General Placement Requirements

- 1) The feet of the Free Standing Track must always be placed on a hard level surface.
- 2) Do not place the feet on surfaces that will cause them to wobble or be unstable. Make sure the surfaces are free of any obstacles that may cause the feet to be unstable.
- 3) Never place the feet on wet surfaces.
- 4) Assemble the Free Standing Track so that the Track is directly over the location where the transfer will occur. For beds, this is generally between 39" - 45" (1000mm - 1145mm) from the head of the bed. For wheelchairs, living room chairs, recliner chairs and similar furniture, this is directly above the center of the seat.

Components

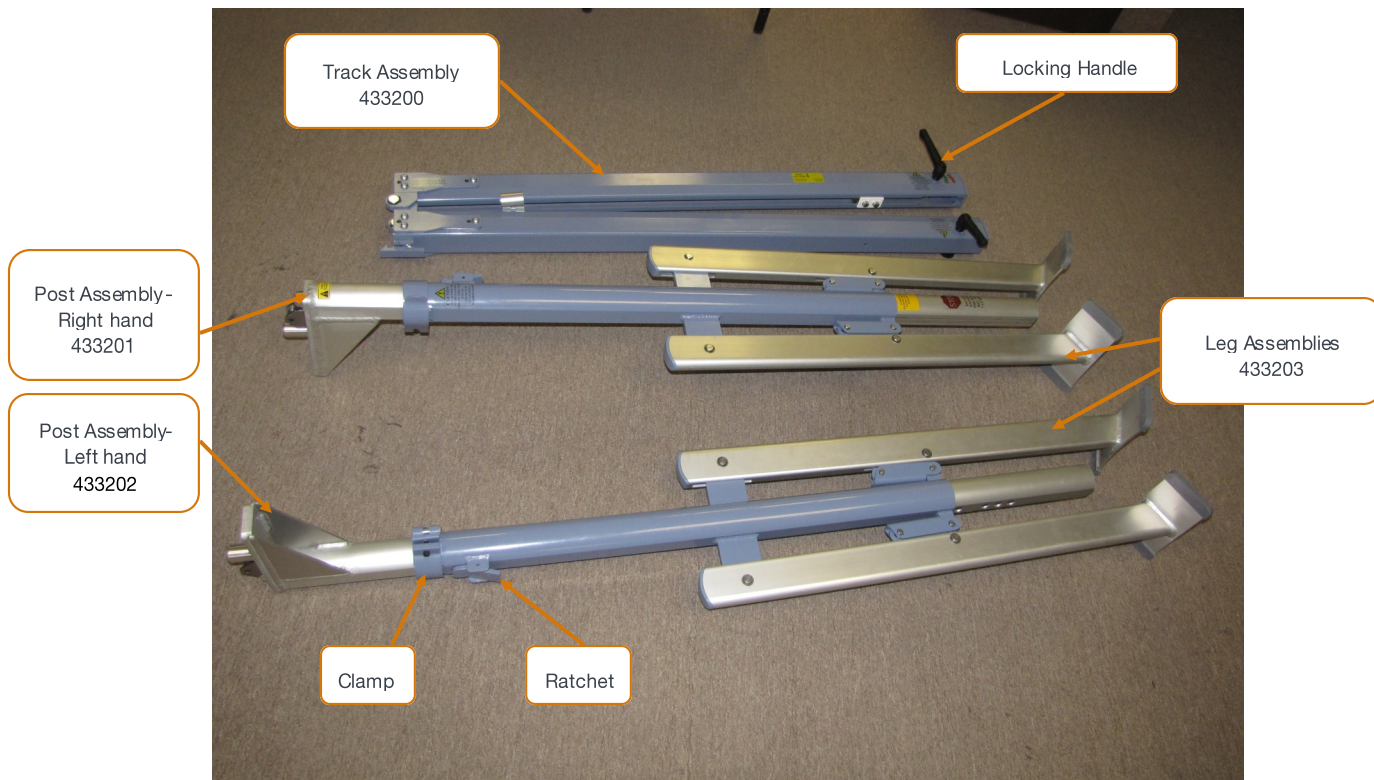

Disassembled Free Standing Track

Assembly Breakdown

Description	Part Number	Quantity
Post Assembly-RH	433201	1
Post Assembly-LH	433202	1
Track Assembly	433200	1
Leg Assembly	433203	2
Owners Manual	633282	1

Specifications

- High-strength, lightweight aluminum
 - Track weight: 15 lb / 6.8kg
 - Post and leg assembly weight: 13 lb / 5.9 kg
 - Unit weight (including trolley): 43 lb / 19.5
- Portable installation
- Eliminates the mounting of a connection system in the ceiling
- One person set up (less than 5 minutes)
- Addresses a number of different set ups
- Maximum safe working load: 300lb / 136 kg
- Adjustable in height
 - Minimum height: 5 ft / 1.52 m
 - Maximum height: 7.5 ft / 2.29 m
 - Height adjustable increments: 2 in / 51 mm

Model Table for the FST 300 System	
Code	Description
341400	Free Standing Track



CAUTION:
DO NOT EXCEED THE CAPACITY OF THE FREE STANDING TRACK
(Maximum Safe Working Load of 300 LB / 136 KG)

Dimensions

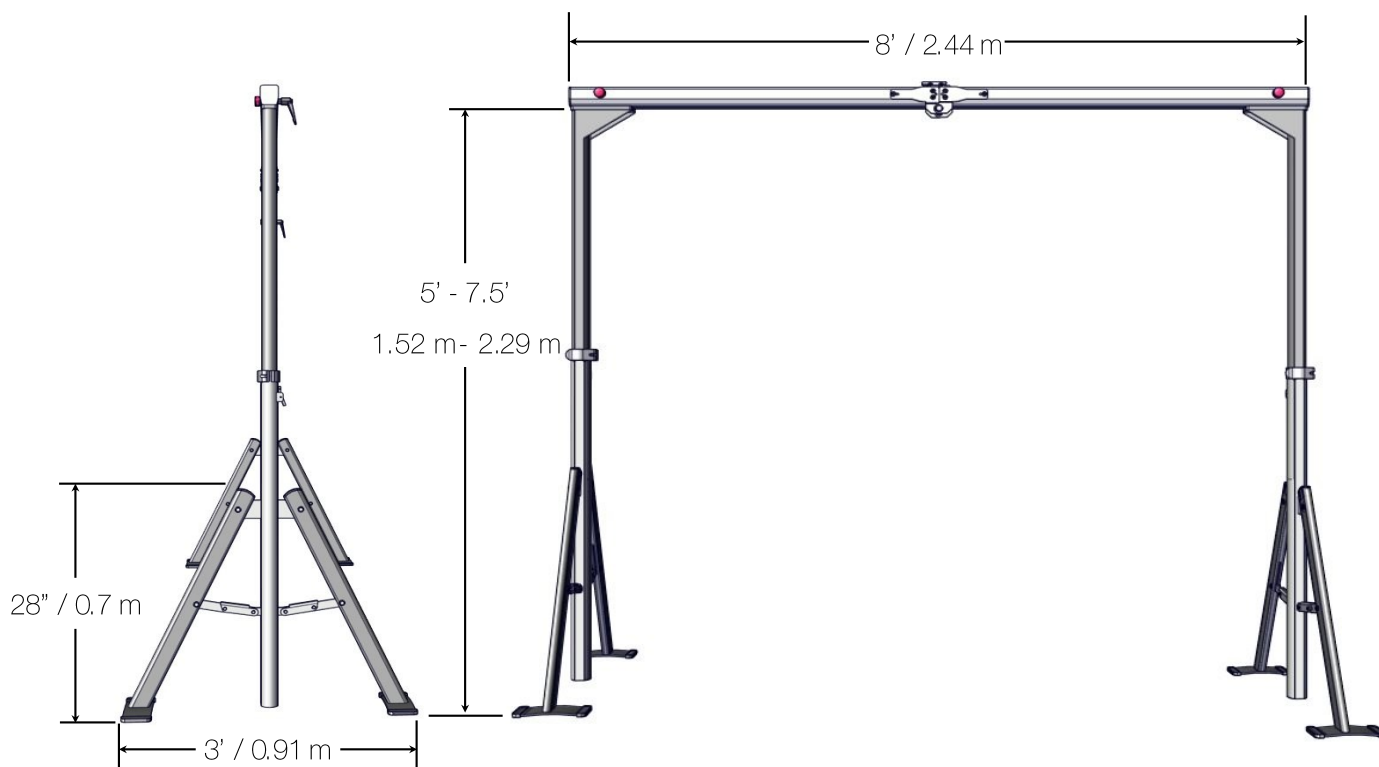

Requirements and Cautions

BEFORE YOU START



Failure to observe cautions listed below could result in serious injury or death

- The Free Standing Track system must be assembled prior to use. Should you have any questions during assembly contact your local authorised dealer.
- The Free Standing Track system parts should not be loose, broken or bent. If any part is missing or damaged do not install. Contact your local authorised dealer immediately.
- Under no circumstance should the track, lift and sling (s) or entire system be put in control of a person who has not been properly trained in the use and care of this equipment. Failure to adhere to this warning may result in serious injury to the operator, and/or the individual being lifted/transferred.
- Never expose the Free Standing Track directly to water.
- Warranty does not cover any misuse or abuse of the Free Standing Track system.
- Any accessories used with the Free Standing Track including lift and sling (s), should be checked to ensure that they are in good working order. Check for signs of wear or fraying prior to use. Report any unusual wear or damage immediately to your local authorised dealer.
- The Free Standing Track and associated lift, and sling (s) are intended **only** for lifting and transferring of a person. Handicare will not be responsible for any damage caused by the misuse, neglect or purposeful destruction of the lift and/or its associated components.
- The installation of the Free Standing Track, lift, accessories, and sling are certified to a maximum load. Do not exceed the maximum rated load of any of the components.
- Ensure that a clear space is maintained around the Free Standing Track. Remove all furniture and other obstacles out of the way before performing a transfer.
- The Free Standing Track has been designed to lift vertically at its maximum load and at maximum height. Do not attempt to lift an individual at an angle to the track.
- Do not install The Free Standing Track on an uneven floor. Do not install on a sloped floor greater than .5 degree.
- Ensure floor area is clear off dirt and debris.
- Do not drop product, it may cause breakage. Protect the Free Standing Track and its accessories during transport.
- Prior to each use of the equipment, complete a visual inspection. A monthly maintenance inspection must be done in order to ensure good operating conditions.
- Make sure the lift is in the designated parking spot before raising or lowering the posts.

Requirements and Cautions

AFTER INSTALLATION



Failure to observe cautions listed below could result in serious injury or death

- Ensure that the Handle lock are fully in locked position as per labels.
- Make sure track is sitting properly on the posts. There should be no gap between Track and Track Holders.
- Make sure all four foot pads are sitting flat on the floor. There should be no gap between the foot pads and floor.
- Make sure clamp levers are locked always when in use.
- During the use of Free Standing Track, do not bump or lean against the posts. This might cause system to become unstable.
- In places where more than one operator will be responsible for using the Free Standing Track, associated lift and sling(s), it is imperative that all operators be trained in its' proper use.
- To maintain optimum function, the Free Standing Track should be inspected and maintained on a regular basis. See the section titled "General Inspection and Maintenance."
- The manufacturer's warranty is void if persons unauthorized by Handicare perform work on the Free Standing Track System.



Do not attempt to lift the patient at an angle. See picture below for example.



Requirements and Cautions

AFTER INSTALLATION



Caution: Before using the Free Standing Track, the Post assembly and track must be visually checked to ensure that they are not damaged. Should anything look unusual, contact your local dealer prior to use.

Failure to comply with this caution could result in serious injury to the operator, the individual being lifted and/or damage to the Free Standing Track and/or portable lift unit.

CLEANING RUBBER FEET

With a water-damped cloth, clean all (8) rubber foot pads prior to each installation. Dry the feet of all moisture and residue. Ensure the floor area is clean and free of dirt and debris.

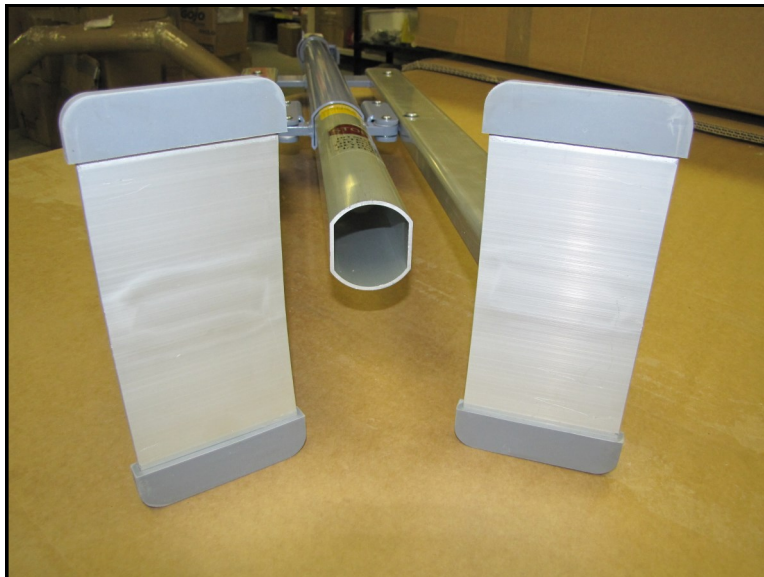

Assembly

SUPPORTING POST



Step 1 - Place the Post in standing position.



Step 2 - Grab the Side leg to open the foot. Always support the post with one hand and open the leg with the other.

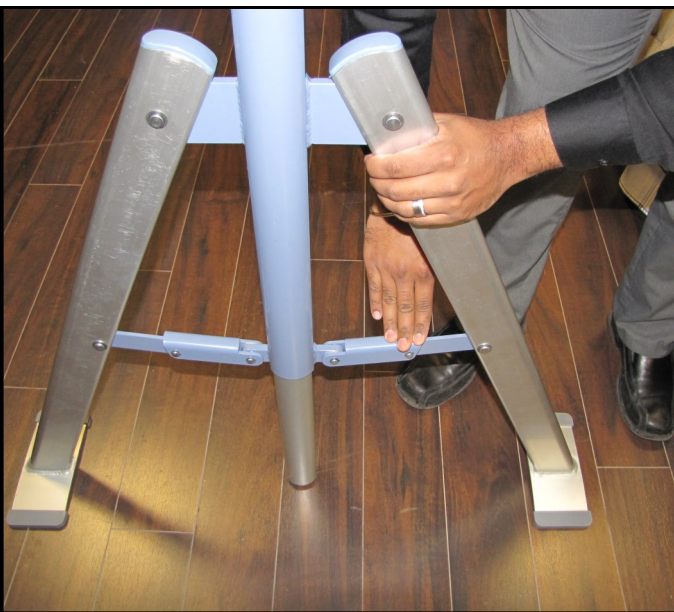

Step 3 - Open the other leg of the post. Make sure that the both hinges are flat and they can not go further down.



Step 4 - Completed post assembly.
Repeat steps 1-4 to finish opposite post assembly.

Completed Post Assembly of Free Standing Track

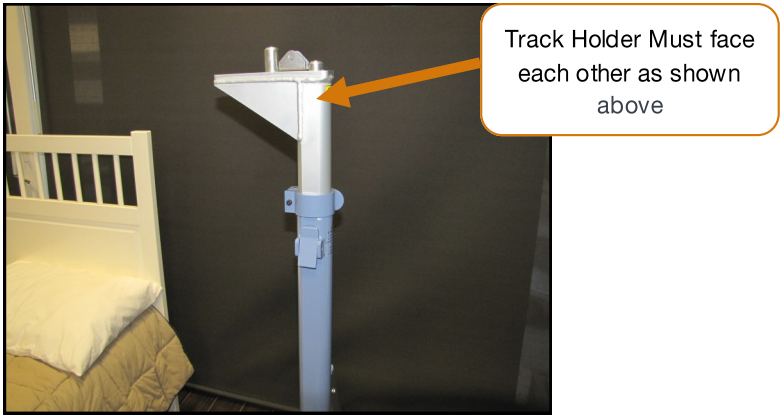

Assembly

TROLLEY INSTALLATION

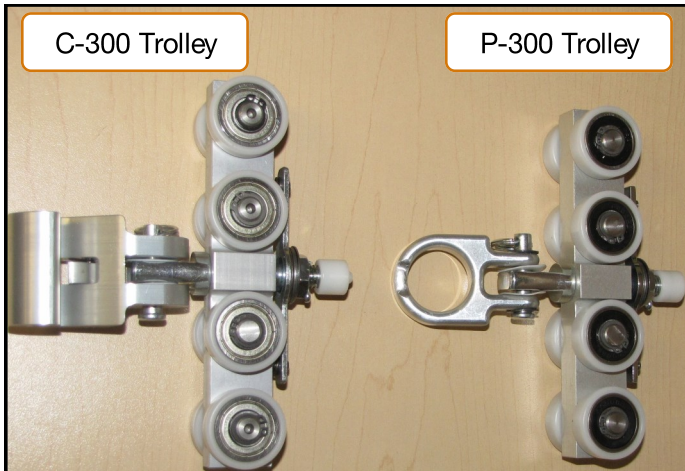

Step 1- Detach the hook/eyelet of trolleys as per step 1 in trolley disassembly (page 27) by removing the split ring and pin.

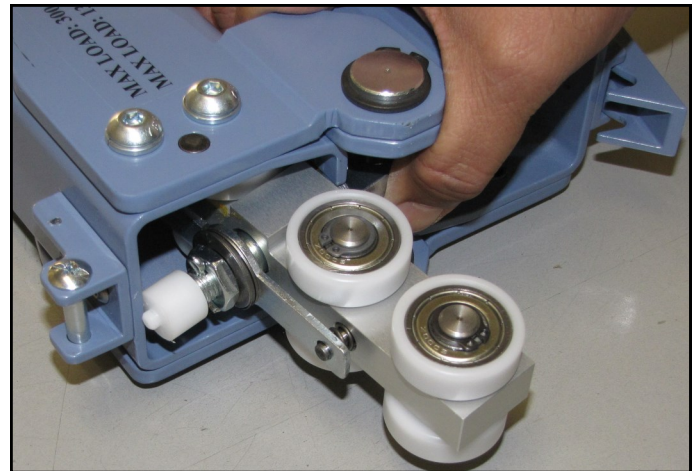

Step 2- Fold and place the track on a secure place. Insert the trolley into the middle of the track.

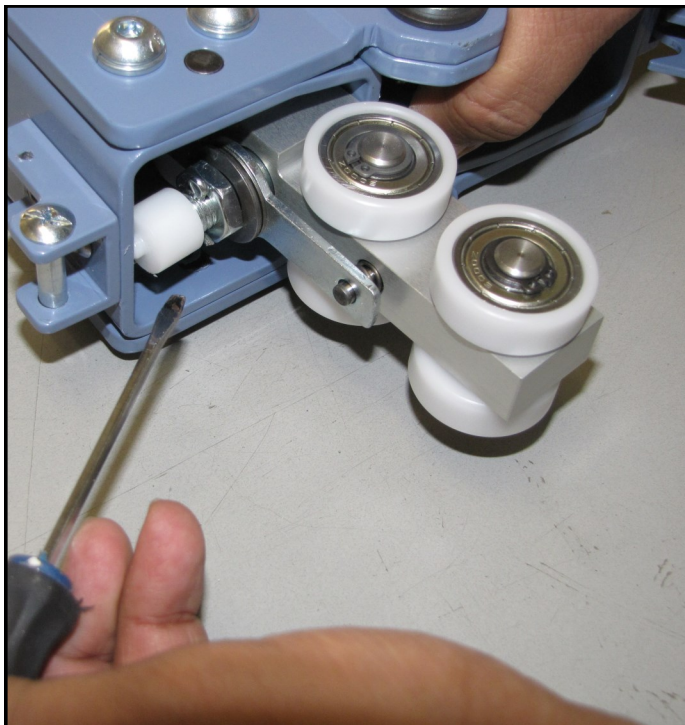

Step 3- Using a screw driver push the trolley lock button down to be able to fit the trolley into the track opening.

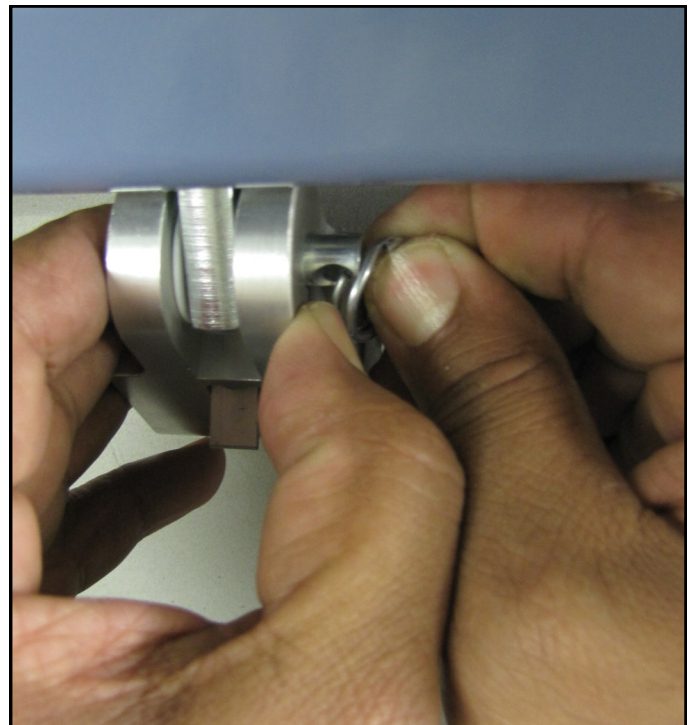

Step 4- Attach the hook/eyelet of the trolley to the trolley using the pin and split ring.

Assembly

TRACK

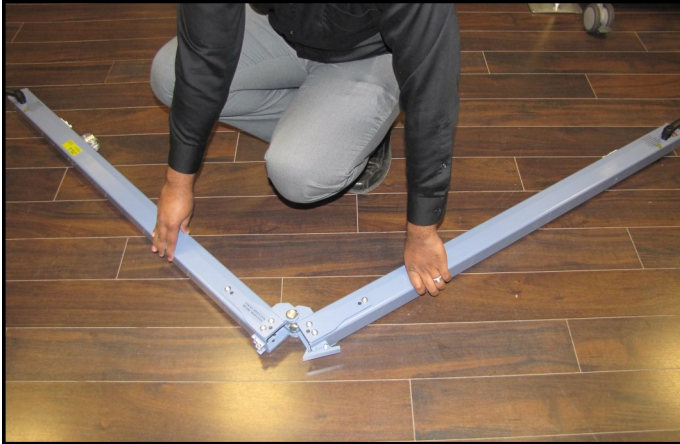

Step 1 - Place the track on the floor. Unfold the track as shown in figure until it is fully straight.

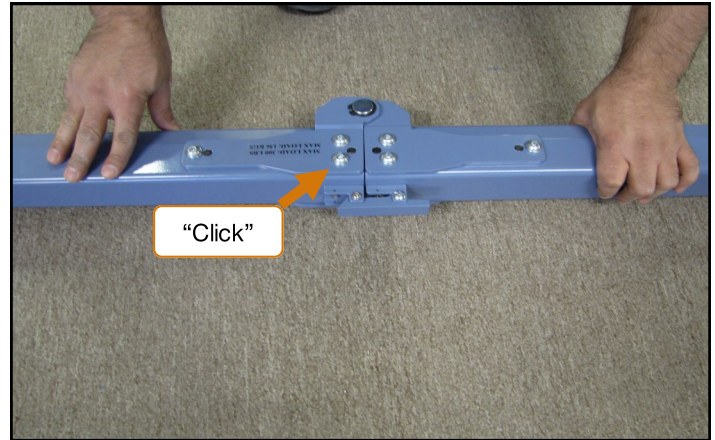

Step 2 - Track should automatically lock itself in place with a "click" sound.

Note: Ensure Track is locked and fully straight.



Note: If you do not hear the "click" sound, press the lock with hand until it is in locking position.

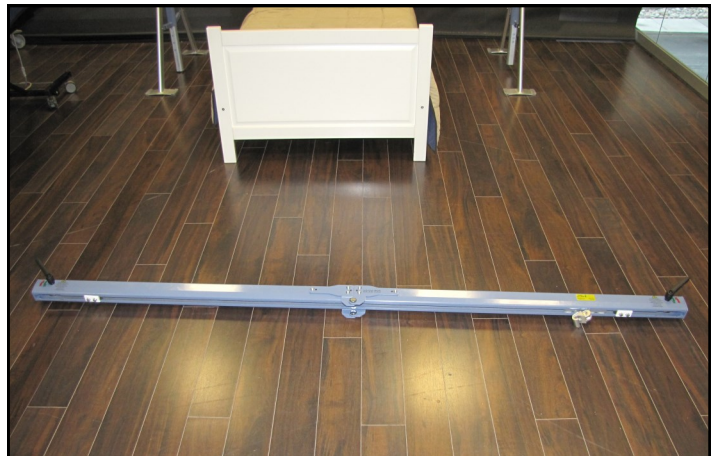

Step 3— Lay Track Flat on the floor.

Assembly

MOUNTING THE TRACK



Step 1 - Place the Track against the floor.

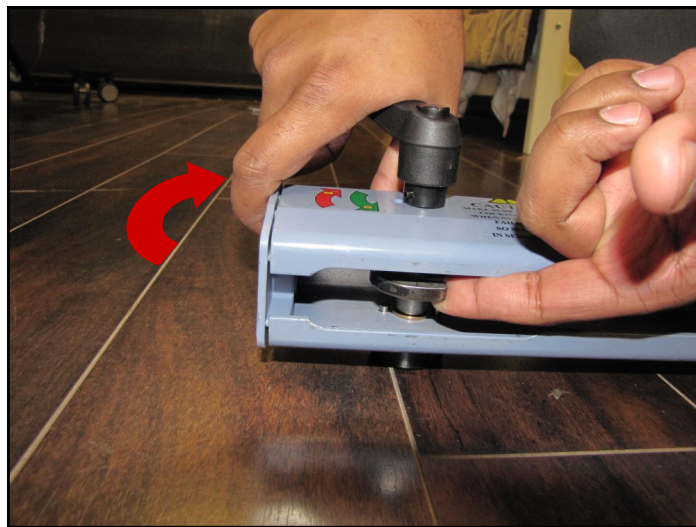

Step 2- Grab the handle and pull the hook inside the track slightly out using a finger and twist the handle towards the unlock direction until the lock is fully opened.



Step 3- Repeat the same step for other side handle.

Assembly

MOUNTING THE TRACK



Step 4- Lift the track with both hands and place one end of the track on the post assembly as shown in figure.

Note: Always make sure that handles are in open position before placing the track on the post.



Step 5- Track should fall into place and sit flat on the track holder of the post as seen in next figure.



Step 6: Place the other end of the track on the other post.

Note: Make sure there is no gap between the Track and Track Holder.



Step 7- Both ends should lay completely flat on the top of post assemblies.

Assembly

MOUNTING THE TRACK



Step 8 - Grab comfort grip plastic knob =.



Step 9 - Hold plastic knob up and place track on post.



Step 10 - Turn the plastic knob clockwise so that the track locks with top post.



Note: Above picture shows that the plastic knob is flush with track, and track locked with top post.

Step 11 - Repeat steps 8 to 10 to lock the other side of the track



Make sure both comfort grip plastic knobs are tight before use

Assembly

MOUNTING THE TRACK



Step 12- Grab track lock handle.



Step 13- Twist the handle downwards in the lock direction.

A big gap should be visible after locking handle

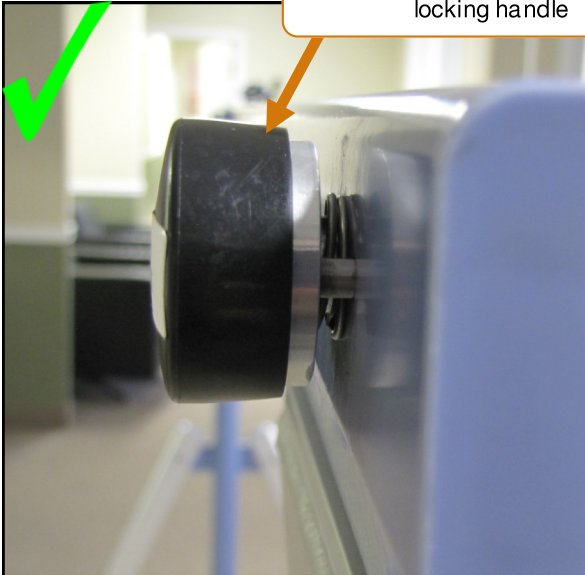

Step 14- Twist until a click is heard, indicating that the track is locked in position and the safety lock pops out.
Note: Big gap between the Track and the safety lock indicates that track is locked as shown above.

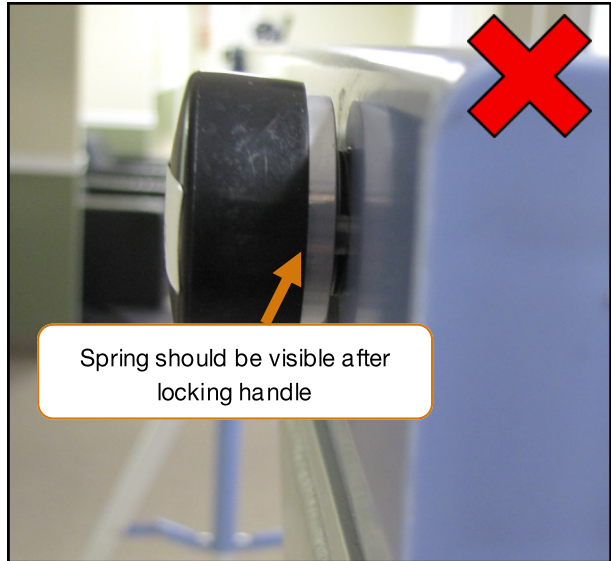

Note: Above picture shows that the track is not completely locked. A click sound should be heard and spring visible.

Step 15- Repeat steps 12 to 14 to lock the other side of the track

 **Make sure both handles are in lock position before use.**
Note: For ease of assembly, track should be raised up to eye-level before mounting the portable lift.

Mounting

C-300



Caution: Prior to mounting the C-300 lift onto the C-300 trolley, read the owners manual of the C-300 lift. Be sure that the instructions on the use of the lift and any accessories, such as slings are thoroughly understood before attempting to use them with the Free Standing Track. Free Standing Track is rated only for 300 lb / 136 kg. Do not exceed the limit of the Free Standing Track.

FAILURE TO COMPLY WITH THIS MAY RESULT IN INJURY TO THE INDIVIDUAL BEING LIFTED AND/OR THE CAREGIVER, OR DAMAGE TO THE LIFT AND/OR THE FREE STANDING TRACK.

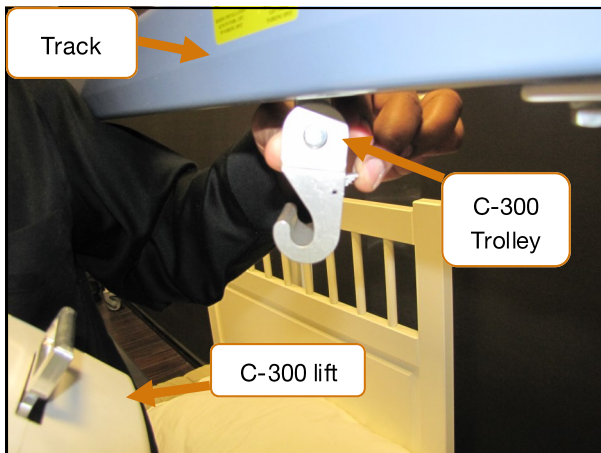

Step 1 - Press latch of the trolley from back as shown in figure. Slide the lift hook on to the trolley hook and release the latch. Follow the figures for the C-300 lift and attach the eyelet of the lift to the hook.



Step 2 - Grab the lift and drag it to the parking spot.



Note: Always make sure that the lift is in parking spot before raising the posts.

Apply load and pull the lift down to be able to remove the lift from parking spot and use it.

Mounting

C-300



Caution: Prior to mounting the P-300 lift onto the P-300 trolley, read the owners manual of the P-300 lift. Be sure that the instructions on the use of the lift and any accessories, such a slings are thoroughly understood before attempting to use them with the Free Standing Track. Free Standing Track is rated only for 300 lb / 136 kg. Do not exceed the limit of the Free Standing Track.

FAILURE TO COMPLY WITH THIS MAY RESULT IN INJURY TO THE INDIVIDUAL BEING LIFTED AND/OR THE CAREGIVER, OR DAMAGE TO THE LIFT AND/OR THE FREE STANDING TRACK.

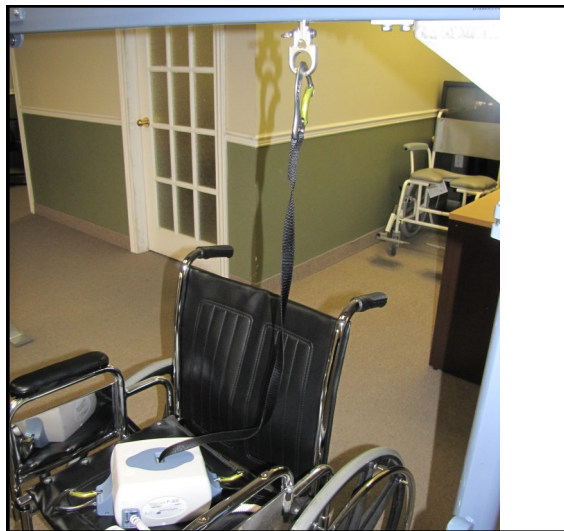
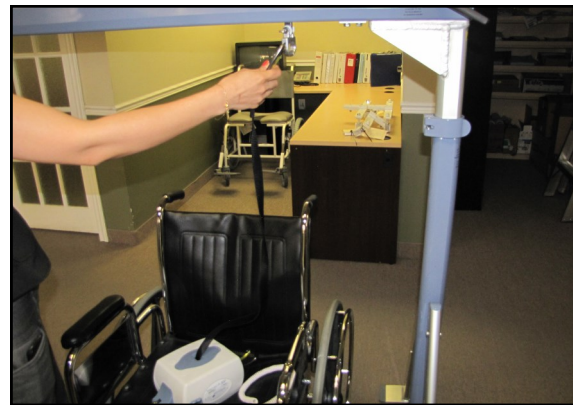
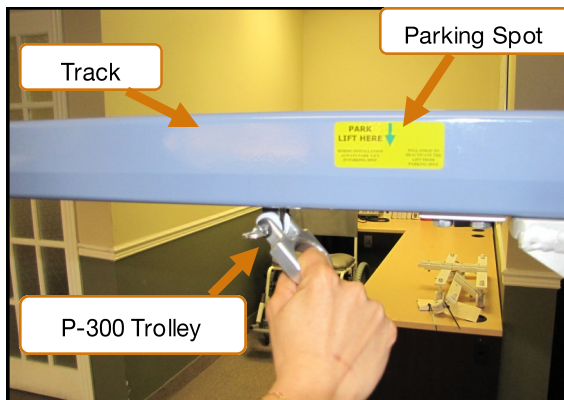

Grab the trolley eyelet and bring it to the parking spot. Once the trolley is in parking spot, Place the portable lift in secure and comfortable position. Pull enough strap out of the lift to be able to hook the carabiner comfortably to the eyelet of the trolley. Put the carabiner of the lift strap into the eyelet of the trolley as shown in figure above. Raise the lift to the track height.

Note: Always make sure that the lift is in the parking spot before raising the posts.

To remove the lift from the parking spot. apply load and pull the lift.

Raising the Free Standing Track



Step 1 - Grab the post center to open the post clamp.



Step 2 - Fully open the clamp.

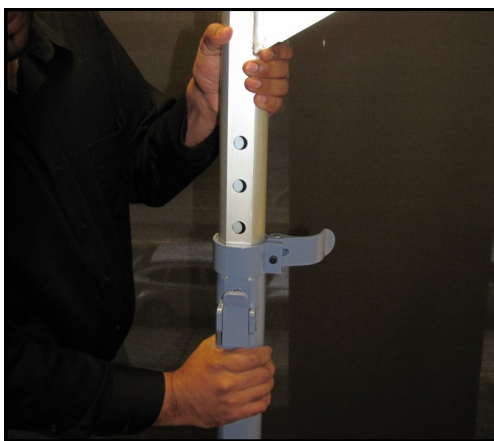

Step 3 - Grab the inner post with one hand and grab the outer post section with the other.



Step 4: Raise the post, ensuring the latch sets into a hole. Reference the height engravings if needed.



Step 5 - Repeating steps 1-5, raise the opposite post.

HEIGHT REFERENCE		
ENGRAVING	HEIGHT (ft)	HEIGHT (m)
1	4.5	1.37
2	5	1.52
3	5.5	1.68
4	6	1.83
5	6.5	1.98
6	7	2.13
MAX	7.5	2.29
LOCKING POSITIONS IN 2 in / 5.1 cm INCREMENTS		

Raising the Free Standing Track



Note: Set up the Free Standing Track by incrementally raising each post assembly, one at a time. It is recommended to reach each post in increments of no more than two engravings (1 ft / 0.3 m).



 **The caution label at the 6 engraving indicates that the height limit of the post is near. Carefully extend the post no further than the “MAX” engraving.**



 **Do not extend post beyond “MAX” engraving. Maximum height of Free Standing Track is 7.5 ft / 2.29 m.**

Raising the Free Standing Track



Step 6 - Close the post clamp as shown in figure.



Step 7 - Make sure the clamp is fully closed on both posts.



Completely Installed Free Standing Track



Always check the following before each use:

- 1) Ensure that both posts are set to the same height and that the system is level.
- 2) No gap between track and track holder.
- 3) No gap between foot pads and floor.
- 4) The ratchet should not be able to be pressed out when the clamp is fully closed.

Accessory

ATTACHING THE SKIRT



Step 1 - Wrap the skirt around the legs and close it using the Velcro hooks.



Step 2 - Use the pocket as a storage for the sling or as you require.

Disassembly



Step 1 - Before disassembly, make sure the lift and/or trolley is in the parking spot.



Step 2 - Open the post clamp.

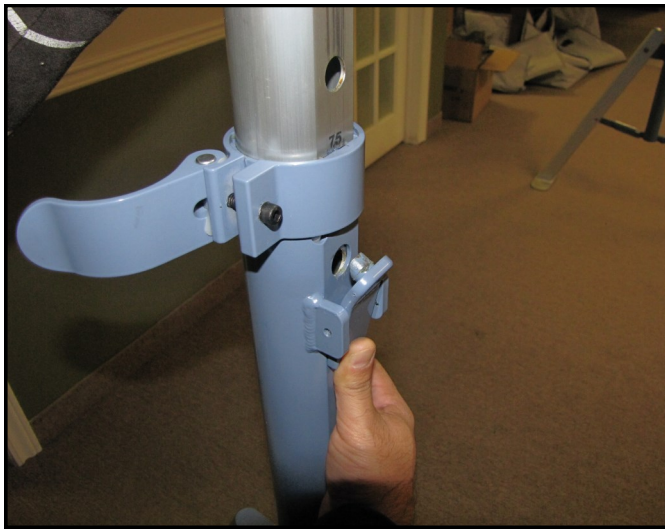

Step 3 - Grab the post and press the ratchet lock with thumb.



Step 4 - Bring down the Free Standing Track by sliding down the inner post while keep pressing down the ratchet lock.

Note: When lowering the post from the highest setting, it is recommended to lower no more than 6 holes at a time (12 in / 0.3 m).



To prevent sudden drop of the post, the ratchet lock should be released at least every 6 holes (12 in / 0.3 m). Failure to do this step might cause injury or damage to the floor.

Disassembly



Note: Free Standing Track will be in a slanting position as shown in figure. Bring down the other side of the Free Standing Track following steps 2-5.



Note: Make sure the posts are parallel and not twisted inside each other. Failing to do that, user might experience resistance in lowering the posts.



Step 5 - Bring the Free Standing Track to the shoulder height and dismantle the lift from the trolley following the user manual of the lift.



Step 6 - Push the safety lock button to unlock the track from Post assembly.

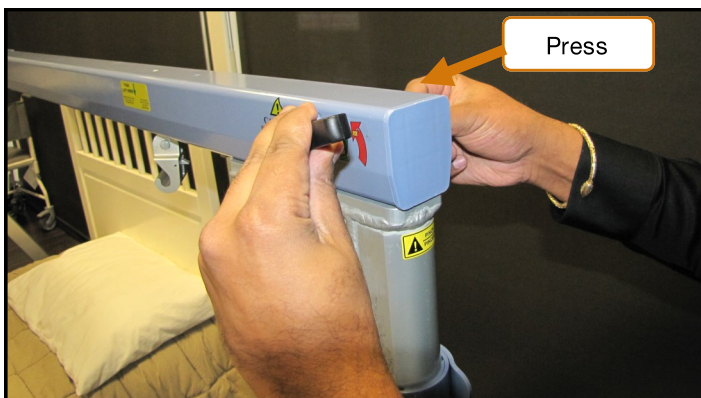

Step 7 - Press the push button and twist handle in unlock direction at the same time.

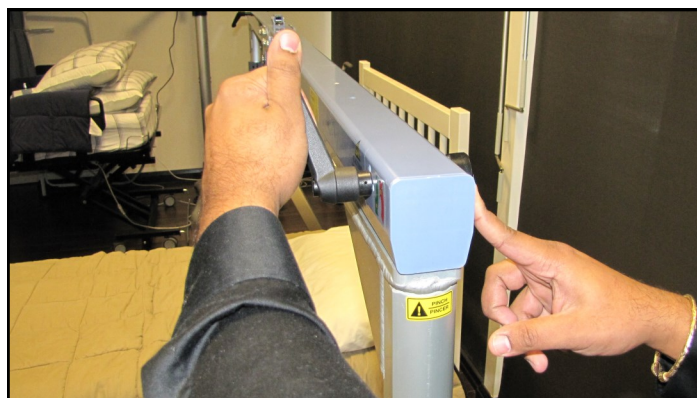

Step 8 - Repeat process for other end to unlock the track.

Disassembly



Step 9 - Unlock the track from top post by turning the plastic knob in anti-clockwise direction.



Step 10 - Make sure that plastic knob is completely unlocked from the top post. Slightly lift the track to check.



Step 11 - Lift the track up from post assembly and place it on the floor.



Step 12 - Press the track lock hook as shown in figure to fold the track. While holding the lock, slightly fold the track.

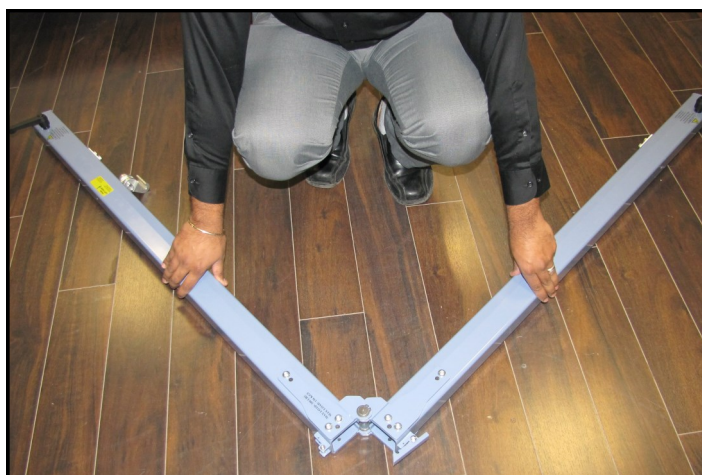

Step 13 - Let go of the lock and fold the track.



Step 14 - Close the track fully.

Disassembly

LEGS



Step 1 - Pull the hinge slightly upwards as shown in figure.



 **Caution:** Do not place your finger underneath the hinge—pinch point.

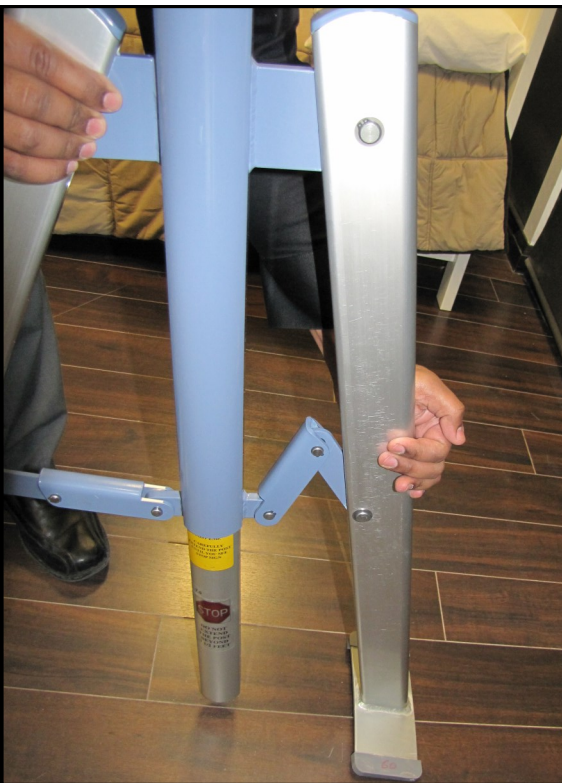

Step 2 - Grab the side leg and press in as shown in figure. Repeat steps 1 and 2 for the other side.



Step 3 - Fully closed legs. Repeat the steps 1 to 3 for the other leg and post assembly.

Trolley Disassembly

C-300 (330051)

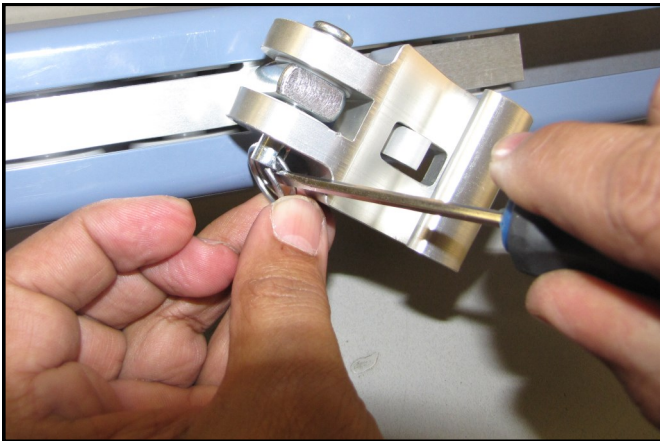

Step 1- Remove the split ring as shown in figure.



Step 2- Detach the hook of the C-300 by taking the pin out as shown in figure.

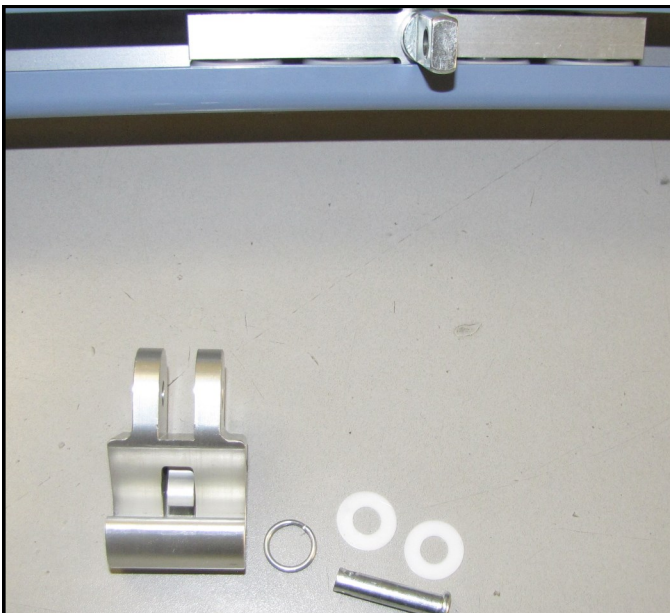

Step 3- Make sure not to lose any part.

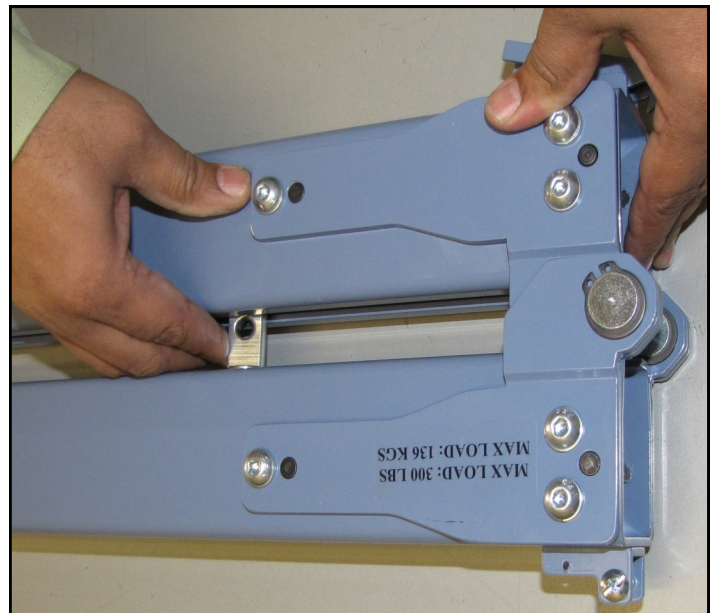

Step 4- Fold and place the track on the floor or on a secure table. Bring the trolley to the opening of the track.

Trolley Disassembly

C-300 (330051)

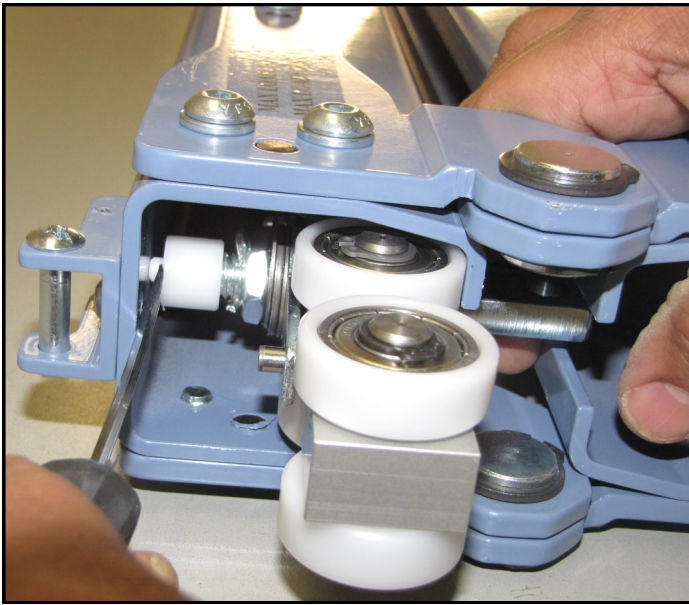

Step 5- Use a screw driver and push the trolley lock button down to allow the trolley to come out.

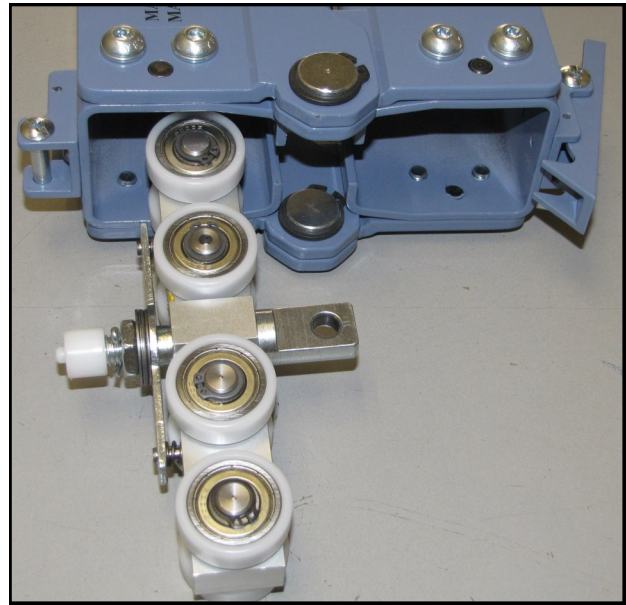

Step 6- Remove the trolley.

Trolley Disassembly

P-300 (330052)



Step 1- Follow the step 1 to 6 from the removing trolley.



Note: Make sure not to lose any part.

Troubleshooting

Should problems arise with the use of the Free Standing Track, review the following chart. Identify the fault and complete the recommended solution. If the fault is not found and/or the solution does not correct the problem, contact your local authorized dealer for service immediately.

Fault	Reason	Recommended Solution
Visually the system is not aligned straight.	<ol style="list-style-type: none"> 1. Post is not set straight. 2. Floor is not leveled. 	<ol style="list-style-type: none"> 1) Set up the post following Post Assembly instructions. Note: Make sure the track is seating completely flat on the track holder. 2) Foot pads must be seating completely flat on the floor. There should be no gap between the foot and floor pads. <p>If problem persists, contact your local authorized dealer immediately.</p>
Feet are slipping after installation.	<ol style="list-style-type: none"> 1. Feet are not cleaned. 2. Floor is not cleaned. 	<ol style="list-style-type: none"> 1) Clean the feet as per "Cleaning Rubber Feet Instructions." 2) Ensure floor area is dry and free of debris. <p>If problem persists, contact your local authorized dealer immediately.</p>
Clamp Lever can not be fully closed.	<ol style="list-style-type: none"> 1. Clamp bolt is tight 	<ol style="list-style-type: none"> 1) Open the Clamp Lever and use 3/16" Allen key to loose the bolt one turn each time. Close the clamp lever and see if closes fully. After closing the clamp press the ratchet. You should not be able to open the ratchet. If the ratchet gets open while the clamp is fully closed, it means that you have loosen the bolt too much. Tight the bolt back till you are not able to open the latch. <p>Note: Do not loose bolt too much. If problem persists, contact your local authorized dealer immediately.</p>
The Folded Track does not sit properly on the post assemblies.	<ol style="list-style-type: none"> 1. Physical damage to track. 2. Handle lock is in lock position. 	<ol style="list-style-type: none"> 1) Check for physical damage to track. If so, contact local authorized dealer immediately. 2) Follow the track assembly instructions and open the handle lock. 3) Posts are not parallel or not standing completely straight.
Trolley does not move smoothly along the adjustable track.	<ol style="list-style-type: none"> 1. Physical damage to track or trolley wheels. 2. Track slots or trolley wheels are not cleaned. 	<ol style="list-style-type: none"> 1) Visually make sure tracks and wheels are not damaged. 2) Ensure that tracks are cleaned with cloth and free of dirt. <p>If problem persists, contact local authorized dealer immediately.</p>
Trolley does not park	<ol style="list-style-type: none"> 1. Parking hole is filled with dirt or debris. 2. Trolley spring is damaged. 3. Trolley lock button is damaged. 	<ol style="list-style-type: none"> 1) Clean the hole with cloth and remove dirt or debris. 2) Contact local authorized dealer. 3) Contact local authorized dealer immediately.
The folded track is not locking on the Post assembly.	<ol style="list-style-type: none"> 1. Track Handle Lock hook damaged or broken. 2. Track Handle Lock Push button damaged or broken. 	<p>Do not use the system. Contact your local authorized dealer immediately.</p>

Ratchet sticks out when lowering or raising and dose not lock	1. Ratchet spring is damaged	1) Do not use the system. Contact your local authorized dealer immediately.
Track lock not working	1. Physical damage to track lock assembly. 2. Track Lock Spring breaks or damaged.	1) Unfold the track and fold it together to see if the track locks in the locking position. If not then contact local authorized dealer immediately. 2) Do track assembly steps and see the if the track locks or not. If not then contact local authorized dealer immediately.
Ratchet can be pushed out when the clamp lever is locked	1. Clamp bolt is loose	1) Open the Clamp Lever and use a 3/16" Allen key to tight the bolt one turn at a time. Close the clamp lever and then push the ratchet to see if it opens up. Note: Do not over tighten the bolt. You should be still able to close the clamp lever without any problem. If problem persists, contact your local authorized dealer immediately.

FAQ

Question: The Free Standing Track seems unstable

Answer: No, provided the Free Standing Track has been installed per the manuals specifications. After spending some time with the device, especially once a client has become accustomed to the device, the lateral stability issue will be less obvious.

Question: How stable is the device?

Answer: This device has been tested as per ISO 10535 requirements for Free Standing Hoists. This testing includes; a 10 degree tilts test (on all four sides) with 375lbs (300lbs safe working load x 1.25). The hoist has passed all testing procedures.

Question: Is the device strong enough to stand the load of 300lb / 136kg?

Answer: This device has been tested to maximum load of 450 lb / 204 kg (300lb / 136 kg safe working load x 1.5). The hoist has passed the test with no sign of defect.

Question: If the floor has a slope, will the trolley slide towards the direction of slope by itself?

Answer: A braking mechanism is integrated to the design of the trolley which prevents it from sliding unintentionally. Force must be applied to be able to move the trolley to the desire location.

General Inspection and Maintenance



Failure to follow inspection and maintenance instructions below may result in serious injury or death.

Periodic general inspection and maintenance should be performed by a person who is properly qualified and trained with the use and care of the Free Standing Track System.

Any defects and damage to the Free Standing Track that have lead to corrective actions should be noted and dated by the inspector. The defects and corrective actions report should be submitted in written form to the dealer.

UPON RECEIPT OF THE FREE STANDING TRACK SYSTEM:

Ensure all the received components are according to the component list.

Ensure the user manual is present, otherwise do not install the Free Standing Track system.

Ensure all the components are in working condition and not damaged.

Ensure service record history forms are included in the package to record any completed service and repairs.

Complete the **Purchase and Service Information** as soon as this equipment is installed.

EACH USE – TO BE COMPLETED BY USER

Prior to each use, the Free Standing Track and associated lift, accessories and sling (s), must be visually inspected. Refer to the lift, accessory and sling user guides for specific details regarding their inspection.

Should any of these items below fail the inspection do not use the Free Standing Track

Contact your local authorized dealer for service

VISUALLY CHECK FOR THE FOLLOWING:

Ensure all the components of Free Standing Track System are in working condition. If damaged, please contact the dealer for replacement before use.

All 4 feet are on a stable, level surface and the supporting post assemblies are secure.

Check rubber feet for damage. If damage is noticed, contact your local authorized dealer for replacement. Make sure that they are clean before placing them on the floor. Refer to cleaning rubber feet instructions.

The post clamps are locked.

The ratchets are locked.

The handles are locked.

The trolley moves easily along the track.

The adjustment track is placed in the correct location for transferring.

Ensure the labels are legible and in good condition. If not contact dealer for replacement.

Record the service record history form for any completed service and repairs.

Ensure that the service record is signed and dated each time it is used.

The portable lift has been inspected as outlined in its owners manual.

The sling(s) has been inspected as outlined in its owners manual.

Service Record History

- Complete the following section- **Purchase and Service Information** as soon as this equipment is installed.
- Use the service record history to record any completed service and repairs.
- Ensure that the service record is signed and dated each time it is used.
- Be sure to have this piece of equipment serviced on a regular basis as described in the General Inspection and Maintenance Section

PURCHASE INFORMATION

Product Name: Free Standing Track System

Serial #: _____

Date of Purchase: _____ **Date Installed:** _____

Purchased From: _____

Address: _____

City: _____ **Post Code:** _____

Telephone No: _____

SERVICE INFORMATION

Contact the following company for service:

Company: _____

Address: _____

City: _____ **Post Code:** _____

Telephone No: _____

Comments:

Service Record History

Complete this section after each service, repair inspection and/or maintenance. Photocopy additional pages as required.

Date: _____		Time: _____	
Service Type: <input type="checkbox"/> Periodic Inspection <input type="checkbox"/> Monthly Inspection <input type="checkbox"/> 6 Month Inspection <input type="checkbox"/> Repair <input type="checkbox"/> Yearly Inspection <input type="checkbox"/> Other: _____			
Completed By: _____		_____	
Printed Name		Signature	
Company: _____			
Remarks & Action Taken:			

Date: _____		Time: _____	
Service Type: <input type="checkbox"/> Periodic Inspection <input type="checkbox"/> Monthly Inspection <input type="checkbox"/> 6 Month Inspection <input type="checkbox"/> Repair <input type="checkbox"/> Yearly Inspection <input type="checkbox"/> Other: _____			
Completed By: _____		_____	
Printed Name		Signature	
Company: _____			
Remarks & Action Taken:			

Date: _____		Time: _____	
Service Type: <input type="checkbox"/> Periodic Inspection <input type="checkbox"/> Monthly Inspection <input type="checkbox"/> 6 Month Inspection <input type="checkbox"/> Repair <input type="checkbox"/> Yearly Inspection <input type="checkbox"/> Other: _____			
Completed By: _____		_____	
Printed Name		Signature	
Company: _____			
Remarks & Action Taken:			

Date: _____		Time: _____	
Service Type: <input type="checkbox"/> Periodic Inspection <input type="checkbox"/> Monthly Inspection <input type="checkbox"/> 6 Month Inspection <input type="checkbox"/> Repair <input type="checkbox"/> Yearly Inspection <input type="checkbox"/> Other: _____			
Completed By: _____		_____	
Printed Name		Signature	
Company: _____			
Remarks & Action Taken:			

Date: _____		Time: _____	
Service Type: <input type="checkbox"/> Periodic Inspection <input type="checkbox"/> Monthly Inspection <input type="checkbox"/> 6 Month Inspection <input type="checkbox"/> Repair <input type="checkbox"/> Yearly Inspection <input type="checkbox"/> Other: _____			
Completed By: _____		_____	
Printed Name		Signature	
Company: _____			
Remarks & Action Taken:			

Date: _____		Time: _____	
Service Type: <input type="checkbox"/> Periodic Inspection <input type="checkbox"/> Monthly Inspection <input type="checkbox"/> 6 Month Inspection <input type="checkbox"/> Repair <input type="checkbox"/> Yearly Inspection <input type="checkbox"/> Other: _____			
Completed By: _____		_____	
Printed Name		Signature	
Company: _____			
Remarks & Action Taken:			

Service Record History

Complete this section after each service, repair inspection and/or maintenance. Photocopy additional pages as required.

Date: _____		Time: _____	
Service Type: <input type="checkbox"/> Periodic Inspection <input type="checkbox"/> Monthly Inspection <input type="checkbox"/> 6 Month Inspection <input type="checkbox"/> Repair <input type="checkbox"/> Yearly Inspection <input type="checkbox"/> Other: _____			
Completed By: _____		_____	
Printed Name		Signature	
Company: _____			
Remarks & Action Taken:			

Date: _____		Time: _____	
Service Type: <input type="checkbox"/> Periodic Inspection <input type="checkbox"/> Monthly Inspection <input type="checkbox"/> 6 Month Inspection <input type="checkbox"/> Repair <input type="checkbox"/> Yearly Inspection <input type="checkbox"/> Other: _____			
Completed By: _____		_____	
Printed Name		Signature	
Company: _____			
Remarks & Action Taken:			

Date: _____		Time: _____	
Service Type: <input type="checkbox"/> Periodic Inspection <input type="checkbox"/> Monthly Inspection <input type="checkbox"/> 6 Month Inspection <input type="checkbox"/> Repair <input type="checkbox"/> Yearly Inspection <input type="checkbox"/> Other: _____			
Completed By: _____		_____	
Printed Name		Signature	
Company: _____			
Remarks & Action Taken:			

Date: _____		Time: _____	
Service Type: <input type="checkbox"/> Periodic Inspection <input type="checkbox"/> Monthly Inspection <input type="checkbox"/> 6 Month Inspection <input type="checkbox"/> Repair <input type="checkbox"/> Yearly Inspection <input type="checkbox"/> Other: _____			
Completed By: _____		_____	
Printed Name		Signature	
Company: _____			
Remarks & Action Taken:			

Date: _____		Time: _____	
Service Type: <input type="checkbox"/> Periodic Inspection <input type="checkbox"/> Monthly Inspection <input type="checkbox"/> 6 Month Inspection <input type="checkbox"/> Repair <input type="checkbox"/> Yearly Inspection <input type="checkbox"/> Other: _____			
Completed By: _____		_____	
Printed Name		Signature	
Company: _____			
Remarks & Action Taken:			

Date: _____		Time: _____	
Service Type: <input type="checkbox"/> Periodic Inspection <input type="checkbox"/> Monthly Inspection <input type="checkbox"/> 6 Month Inspection <input type="checkbox"/> Repair <input type="checkbox"/> Yearly Inspection <input type="checkbox"/> Other: _____			
Completed By: _____		_____	
Printed Name		Signature	
Company: _____			
Remarks & Action Taken:			

Service Record History

Complete this section after each service, repair inspection and/or maintenance. Photocopy additional pages as required.

Date: _____		Time: _____	
Service Type: <input type="checkbox"/> Periodic Inspection <input type="checkbox"/> Monthly Inspection <input type="checkbox"/> 6 Month Inspection <input type="checkbox"/> Repair <input type="checkbox"/> Yearly Inspection <input type="checkbox"/> Other: _____			
Completed By: _____		_____	
Printed Name		Signature	
Company: _____			
Remarks & Action Taken:			

Date: _____		Time: _____	
Service Type: <input type="checkbox"/> Periodic Inspection <input type="checkbox"/> Monthly Inspection <input type="checkbox"/> 6 Month Inspection <input type="checkbox"/> Repair <input type="checkbox"/> Yearly Inspection <input type="checkbox"/> Other: _____			
Completed By: _____		_____	
Printed Name		Signature	
Company: _____			
Remarks & Action Taken:			

Date: _____		Time: _____	
Service Type: <input type="checkbox"/> Periodic Inspection <input type="checkbox"/> Monthly Inspection <input type="checkbox"/> 6 Month Inspection <input type="checkbox"/> Repair <input type="checkbox"/> Yearly Inspection <input type="checkbox"/> Other: _____			
Completed By: _____		_____	
Printed Name		Signature	
Company: _____			
Remarks & Action Taken:			

Date: _____		Time: _____	
Service Type: <input type="checkbox"/> Periodic Inspection <input type="checkbox"/> Monthly Inspection <input type="checkbox"/> 6 Month Inspection <input type="checkbox"/> Repair <input type="checkbox"/> Yearly Inspection <input type="checkbox"/> Other: _____			
Completed By: _____		_____	
Printed Name		Signature	
Company: _____			
Remarks & Action Taken:			

Date: _____		Time: _____	
Service Type: <input type="checkbox"/> Periodic Inspection <input type="checkbox"/> Monthly Inspection <input type="checkbox"/> 6 Month Inspection <input type="checkbox"/> Repair <input type="checkbox"/> Yearly Inspection <input type="checkbox"/> Other: _____			
Completed By: _____		_____	
Printed Name		Signature	
Company: _____			
Remarks & Action Taken:			

Date: _____		Time: _____	
Service Type: <input type="checkbox"/> Periodic Inspection <input type="checkbox"/> Monthly Inspection <input type="checkbox"/> 6 Month Inspection <input type="checkbox"/> Repair <input type="checkbox"/> Yearly Inspection <input type="checkbox"/> Other: _____			
Completed By: _____		_____	
Printed Name		Signature	
Company: _____			
Remarks & Action Taken:			

Warranty

This Warranty does not affect or in any way limit your Statutory Rights.

Handicare guarantees all equipment, which includes Ceiling Lifts, Floor Lifts, Slings, Service Parts and Track and accessories, supplied as new, against failure within the period of 1 year from date of installation or 18 months from date of manufacturing, whichever is shorter, by virtue of defects in material or workmanship.

Handicare guarantees all refurbished equipment supplied against failure within a period of three months from date of installation or six months from date of purchase whichever is shorter.

This guarantee does not apply to failure attributable to normal wear and tear, damage by natural forces, user neglect or misuse or to deliberate destruction, or to batteries more than 90 days after original purchase.

This guarantee shall be void if the equipment is not serviced by Handicare or its authorized service agents in accordance with the manufacturer's recommendations or if any unauthorized person carries out works on the equipment.

The liability of Handicare under the terms of this guarantee shall be limited to the replacement of defective parts and in no event shall Handicare incur liability for any consequential or unforeseeable losses.

CAUTION: DO NOT ATTEMPT TO USE THIS EQUIPMENT WITHOUT FIRST UNDERSTANDING THE CONTENTS OF THIS MANUAL

If you have any questions about the manufacture or operation

your local authorized dealer.

