

INSTRUCTIONS FOR USE

AtmosAir Velaris

Hybrid mattress system





WARNING

To avoid injury, always read this Instructions for use and accompanied documents before using the product.



Mandatory to read the Instructions for use.

Design Policy and Copyright

® and ™ are trademarks belonging to the Arjo group of companies.

© Arjo 2021.

As our policy is one of continuous improvement, we reserve the right to modify designs without prior notice.

The content of this publication may not be copied either whole or in part without the consent of Arjo.

Contents

Foreword	5
Intended use	6
Safety instructions	8
Preparation	9
Parts designation	10
Control panel	14
Run/Standby button and light	14
Lock button and light	14
Audio off light	14
Weight select buttons and lights	15
Audio alarm pause button and light	15
Power fail light	16
System fault light	16
Low pressure light	16
Skin IQ light	16
Product description - Alternating pressure pump	17
Repeater light	17
Hanging brackets	17
Power cable	17
Skin IQ port	18
Audio on/off switch	18
Day/Night mode	18
Product description - Standard and Plus mattress	19
Covers	19
Mattress connector	19
Connect the pump to the mattress	19
Disconnect the pump from the mattress	20
Handles	21
Non-slip base	21
Cable management loops	21
Product description - Stretcher (ST) mattress	22
Covers	22
Handles	22
Non-slip base	22
Product description - Seat cushion	23
Covers	23
Handle	23
Non-slip base	23

Assemble the hybrid mattress system	24
Assemble the Standard, Plus and ST mattresses	24
Reactive therapy	26
Patient position	26
Active therapy (Standard or Plus mattress)	27
Patient position	27
System start-up	27
Turn-off and remove the pump	28
Store the pump	28
Homecare use	29
Cleaning and disinfection	30
Clean and disinfect	32
Care and preventive maintenance	34
Troubleshooting and alarms	37
Technical specifications	38
Labels	42
List of standards and certificates	46
Electromagnetic compatibility	47

Foreword

Thank you for purchasing the AtmosAir Velaris® hybrid mattress system.

Customer contact information

For questions regarding this product, supplies, maintenance, or other Arjo products and services, contact Arjo, an Arjo authorised representative or visit www.arjo.com.

Read and fully understand this IFU before using the product

The information in these Instructions For Use (IFU) is necessary for the proper operation and maintenance of your device. It will help to protect your product and make sure that it performs to your satisfaction. The information in this IFU is important for your safety. You must read and understand the IFU to help prevent possible injury. Unauthorised modifications on any Arjo device can affect its safety and performance. Arjo cannot be held responsible for any accidents or incidents resulting from such modifications to its products.

Service and support

Routine maintenance before every use or every week (in long-term care) is necessary to maintain the safety and reliability of the product. See the Care and preventive maintenance section for more information. If you require further information or spare parts, see Customer contact information.

Serious incident

If a serious incident occurs in relation to this medical device, affecting the user, or the patient, then the user or patient should report the serious incident to the medical device manufacturer or the distributor. In the European Union, the user should also report the serious incident to the Competent Authority in the member state where they are located.

Definitions in this IFU

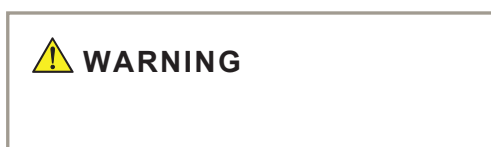

Warning means: Safety warning. Failure to understand and obey this warning may result in injury to you or others.



Caution means: Failure to follow these instructions may cause damage to all or parts of the system or device.



Note means: This is important information for the correct use of this system or device.

Intended use

The AtmosAir Velaris hybrid mattress system is intended for use by caregivers¹ in acute care, long-term care and home care facilities, including private homes.

The hybrid mattress system is indicated for the prevention and management of pressure injuries. It should be used as part of an individualised, comprehensive pressure injury protocol. This includes: repositioning, nutritional support and skin care. The surface should be selected based on full assessment of the patient needs.

The hybrid mattress system represents one aspect of a pressure injury management protocol. All other aspects of care should be considered by the healthcare professional.

If existing wounds do not improve, or the patient's condition changes the overall therapy regimen should be reviewed by the healthcare professional.

As guidance the system when used in an unpowered reactive mode is indicated for patients that are deemed to be 'At Risk' of a pressure injury. If the system is used in conjunction with the pump, the patients with a 'higher risk profile' may be considered.²

The above are guidelines only and should not replace clinical judgement.

The Standard mattress system is for patients within the weight range of 40 kg (90 lb) to 250 kg (550 lb). Heavier patients weighing up to 454 kg (1000 lb) should use the Plus (bariatric) mattress system.

The hybrid mattress system should only be used for the purpose specified in this Instructions for Use. Any other use is prohibited.

1 Caregiver may be a healthcare professional or lay person who operates this medical device.

2 European Pressure Ulcer Advisory Panel, National Pressure Injury Advisory Panel and Pan Pacific Pressure Injury Alliance. *Prevention and Treatment of Pressure Ulcers/Injuries: Clinical Practice Guideline. The International Guideline.* Emily Haesler (Ed). EPUAP/NPIAP/PPPIA: 2019, Chapter 4 Risk Factors and Risk Assessment

Contraindications

In powered active alternating mode with the pump,- Do not use the hybrid mattress system with patients with an unstable cervical, thoracic and/or lumbar fracture, cervical traction, and skeletal traction. For any other conditions that may be complicated by a moving surface, do not use the hybrid mattress system.

In the non-powered reactive mode without the pump, - It may be possible to use the surface for patients with unstable cervical, thoracic and/or lumbar fracture, cervical traction, and skeletal traction if assessed by a healthcare professional as suitable to do so. Ongoing assessment and continuous monitoring of the patient is advised.

Patient assessment

Facilities should establish regular assessment routines. Caregivers should assess each patient before using the product. The patient weight must not exceed:

- 250 kg (550 lb) for the Standard mattress
- 454 kg (1000 lb) for the Plus (bariatric) mattress
- 250 kg (550 lb) for the Stretcher (ST) mattress
- 250 kg (550 lb) for the Seat cushion

If the patient does not meet these criteria an alternative medical device/system shall be used.

Expected service life

The expected service life of the AtmosAir Velaris system elements is:

- Mattress – 5 Years
- Seat Cushion – 5 Years
- Pump – 7 Years

The expected service life of this device is subject to preventive maintenance being carried out in accordance with the instructions for care and maintenance found in this Instructions for Use.

Safety instructions

 **WARNING**

To avoid risks of tripping or strangulation, always use the cable management for the power cable.

 **WARNING**

To avoid injury, keep the mains power socket and plug accessible at all times. To safely cut off the pump's power supply, remove the plug from the mains outlet.

 **WARNING**

To avoid pressure injury, make sure that the hybrid mattress system is assembled correctly.

 **WARNING**

To avoid bodily injury, do not use the mattress or ST mattress as a patient movement device.

 **WARNING**

To avoid injury and/or unsafe product, do not use unapproved accessories or attempt to modify, disassemble or otherwise misuse the hybrid mattress system.

 **WARNING**

Do not attempt to service or maintain the pump while it is in use.

 **WARNING**

To avoid falls and injury, make sure that cables and the tube-set are positioned correctly. Keep cables away from moving bed parts or other possible entrapment areas.

 **WARNING**

To avoid pressure injury the patient must not wear clothing that may cause areas of localized high pressure due to creases, seams, etc. Objects in pockets must be avoided for the same reason.

 **WARNING**

To avoid reduced benefits from the mattress, do not place extra layers between the patient and the mattress.

CAUTION

To avoid damage to the device, do not use sharp objects or electrical heat under the blankets on or under the hybrid mattress system.

CAUTION

To avoid damage, do not expose the device to naked flames, such as cigarettes. This is especially important for the mattress. A leak in the mattress (Standard and Plus) may propagate the fire.

CPR

Level the bed and disconnect the Velaris pump (if connected). Lower the side rails and initiate CPR as detailed in the facility protocols.

Preparation

Bed frame recommendation

The mattress range is designed to be used on Arjo bed frames. See Technical specifications on page 38 of this IFU.

The mattress range (Standard, Plus and ST) may also be used with other bed frames or trolleys (non-Arjo). The clinician or caregiver should assess the needs and determine which mattress and bed frame to use. See the bed frame IFU for compatible mattress sizes. Find the dimensions of all mattresses in section Measurements and compatibility on page 40.

Actions before first use

1. Visually check the package for damage. If the package is damaged, contact the transport agency. Do NOT use the product.
2. Read this IFU.
3. Check that all parts of the product are supplied: Compare to section Parts designation on page 10. If any part is missing or damaged – do NOT use the product.
4. Recycle the packaging according to local regulations.
5. Choose a designated area where this Instructions for Use should be kept and is easily accessible at all times.

Actions before every use

Inspect the hybrid mattress system according to section Care and preventive maintenance on page 34. If any item is damaged - do NOT use the product.

Action after each patient

Clean and disinfect the product after each patient according to section Cleaning and disinfection on page 30.

Parts designation

Alternating pressure pump

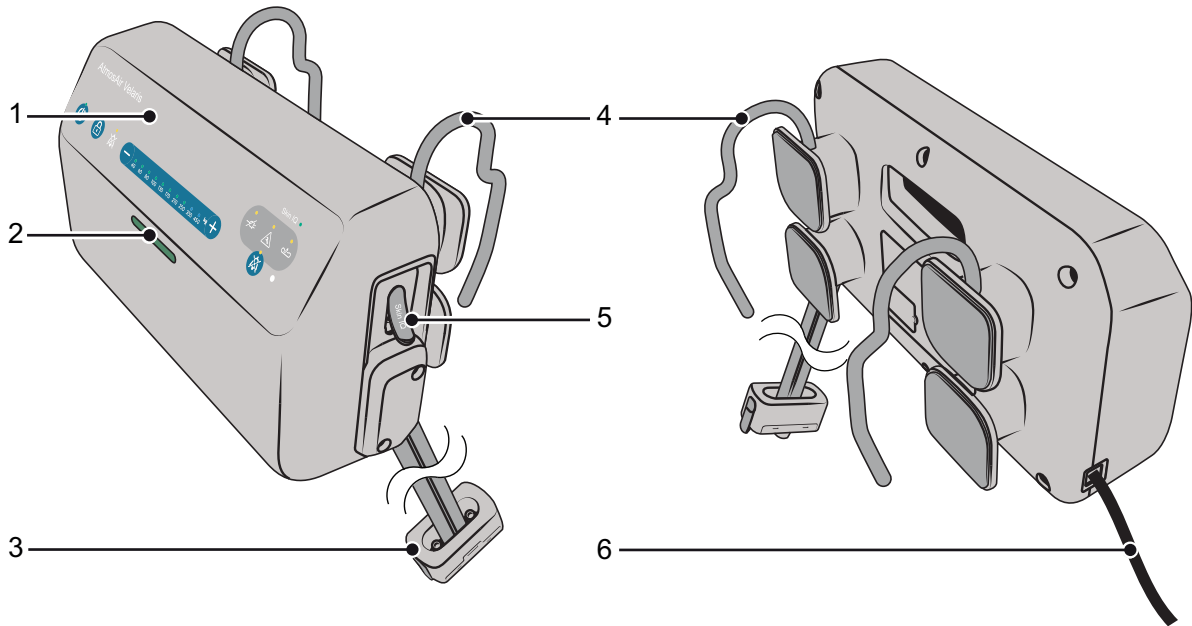

- | | |
|--------------------------------|---------------------|
| 1. Control panel (with lights) | 4. Hanging brackets |
| 2. Repeater light | 5. Skin IQ port |
| 3. Tube-set connector | 6. Power cable |

Control panel

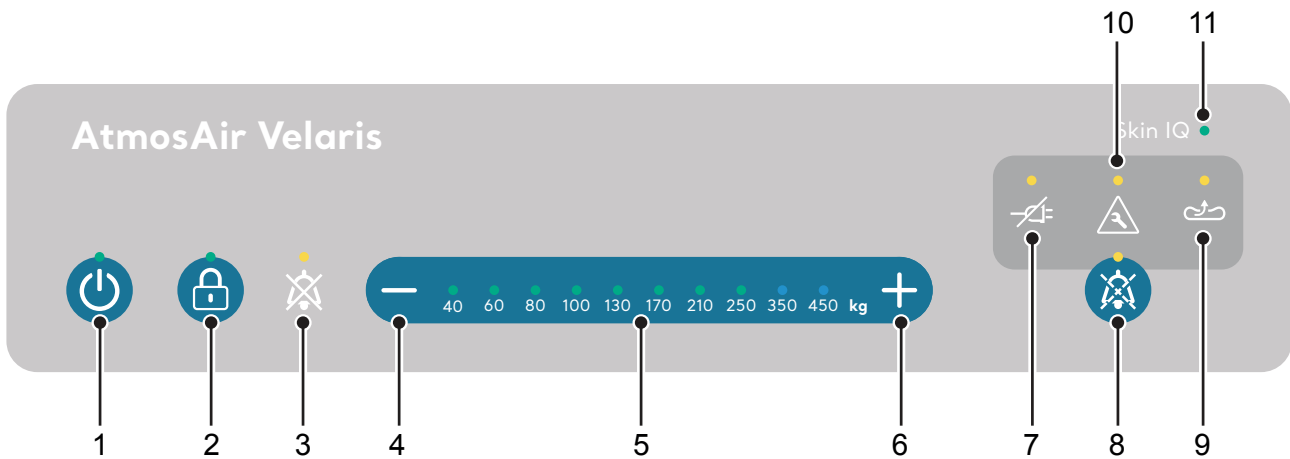

- | | |
|---------------------------------|---------------------------------------|
| 1. Run/Standby button and light | 7. Power fail light |
| 2. Lock button and light | 8. Audio alarm pause button and light |
| 3. Audio OFF light | 9. Low pressure light |
| 4. Weight decrease button (-) | 10. System fault light |
| 5. Weight selected light | 11. Skin IQ connected light |
| 6. Weight increase button (+) | |

Standard and Plus mattress

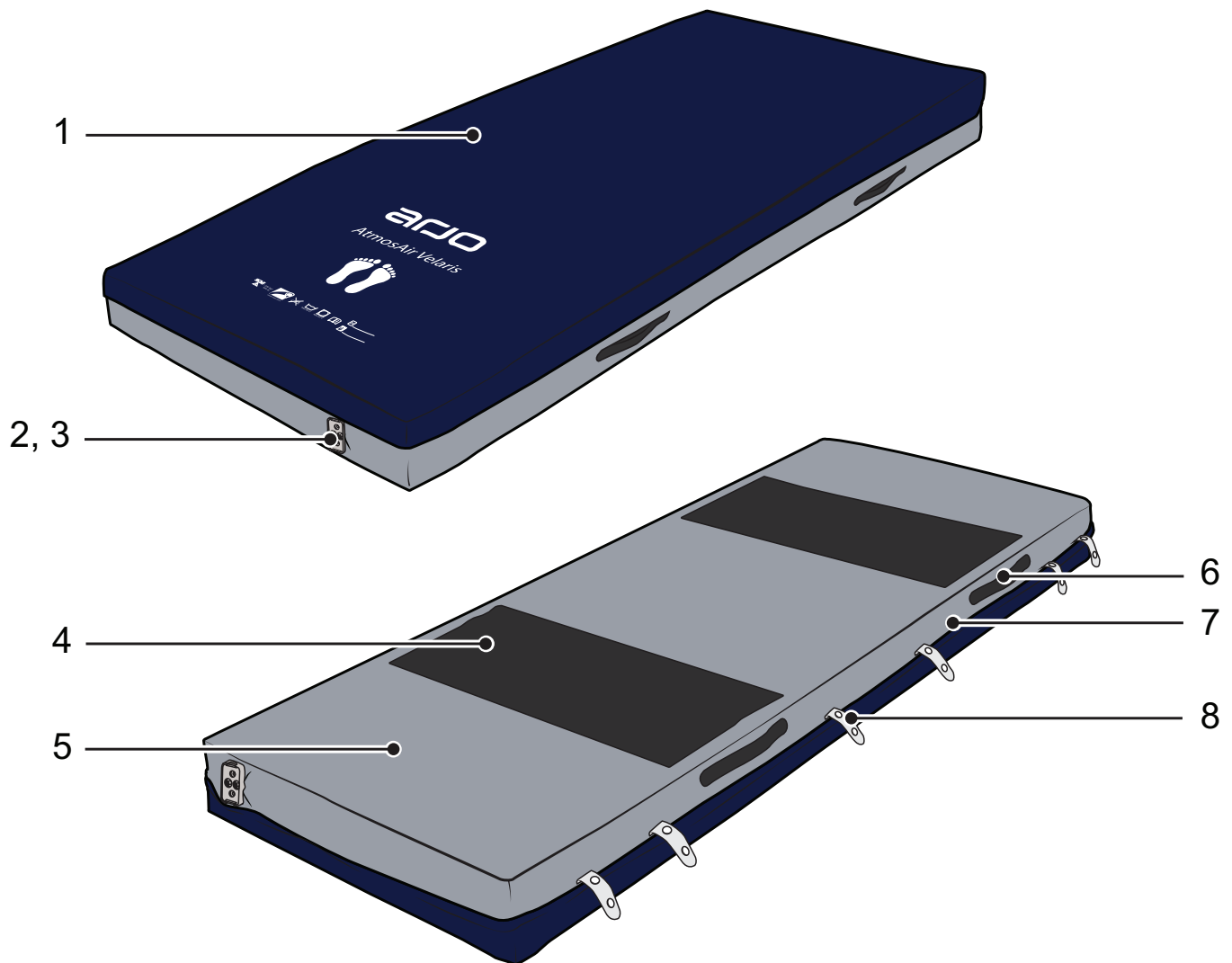

1. Detachable top cover
2. Mattress connector
3. Mattress connector cavity
4. Non-Slip strips
5. Detachable bottom cover
6. Handles
7. Cover attachment zip with zip flap
8. Cable management loops

Stretcher (ST) mattress

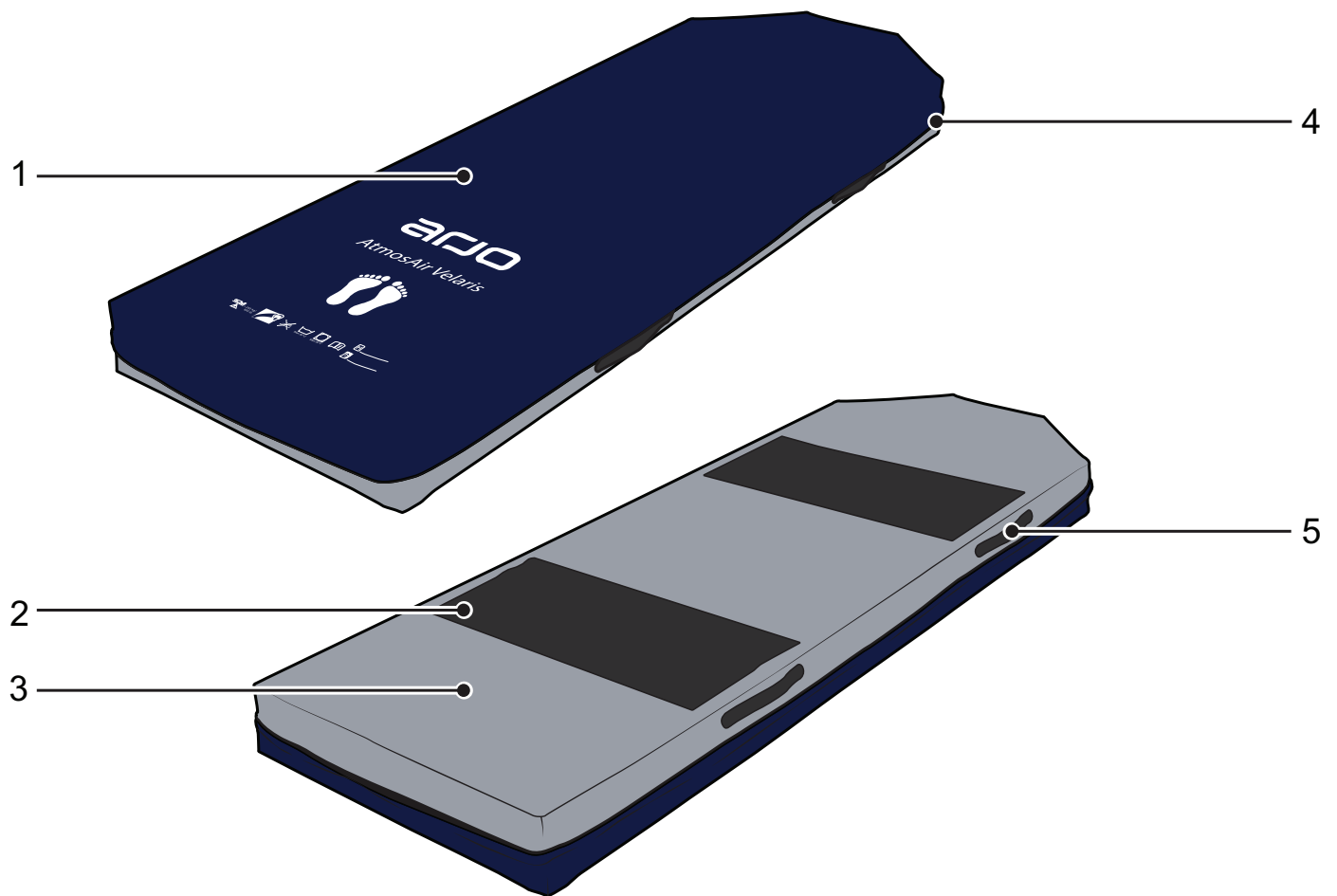

1. Detachable top cover

2. Non-Slip strips

3. Detachable bottom cover

4. Cover attachment zip with zip flap

5. Handles

Seat cushion

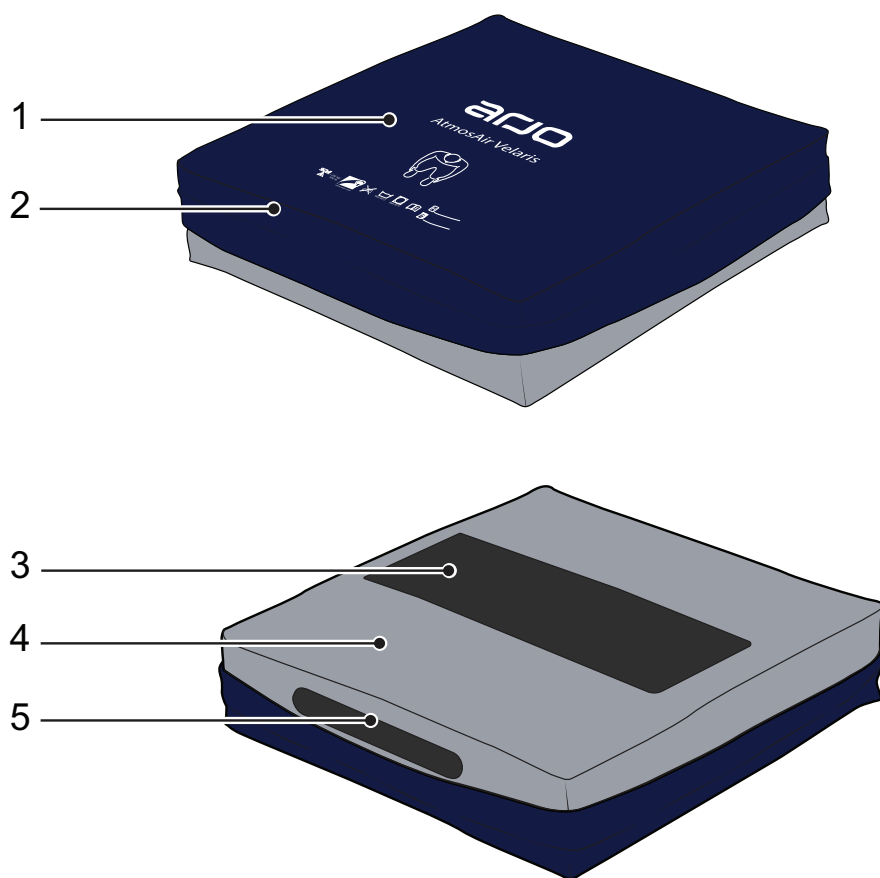

1. Detachable top cover

2. Cover attachment zip with zip flap

3. Non-Slip strip

4. Detachable bottom cover

5. Handle

Control panel



Figure 1

Run/Standby button and light

See Figure 1

The Run/Standby button switches the pump between Run mode and Standby mode.

In Run mode the light is on.

For Standby mode, press and hold the button for two seconds. The light turns off.



Figure 2

Lock button and light

See Figure 2

To lock the control panel, press and hold the Lock button for 2 seconds. When locked the light turns on.

To unlock all control panel buttons, press and hold the Lock button for two seconds. When unlocked the light turns off.

The control panel buttons automatically lock after 60 seconds if no control panel button is pressed.



Figure 3

Audio off light

See Figure 3

The Audio off light turns on when the Audio notifications and alarms have been permanently disabled.

See Audio on/off switch on page 18

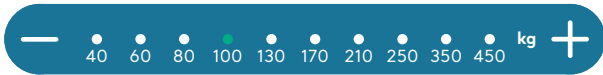

Figure 4

Weight select buttons and lights

See Figure 4

The default weight is set and the light is on at 100 kg (220 lb).

- Press the - button to reduce the patient weight. Minimum value is 40 kg (90 lb).
- Press the + button to increase the patient weight. Maximum value is 450 kg (1000 lb).

For each button press the weight reduces/increases by one step.

The selected weight is indicated by a green light.

The Plus mattress weight settings (350 kg and 450 kg) are indicated by a blue light when selected.

Always round up the patient's weight to the next higher value.



Figure 5

Audio alarm pause button and light

See Figure 5

Press the Audio alarm pause button to silence the audible alarm for 15 minutes. The light turns on.

Press the button again to cancel the alarm pause.

Figure 6



Power fail light

See Figure 6

If a power failure is detected the power failure light turns on and an alarm sounds.

Active (alternating) therapy is not possible during power failure conditions.

NOTE

To turn the pump off and cancel the alarm during a power outage, press and hold the run/standby button for two seconds.

Figure 7



System fault light

See Figure 7

If an internal fault of the pump is detected during Built-In Self-Test (BIST) or during therapy, the system fault light turns on and an alarm sounds

Figure 8



Low pressure light

See Figure 8

If the mattress fails to achieve the target pressure, the low pressure light turns on and an alarm sounds.

Figure 9



Skin IQ light

See Figure 9

The Skin-IQ light turns on when a Skin-IQ coverlet is connected to the Skin IQ power outlet port.

See Figure 13.

Product description - Alternating pressure pump

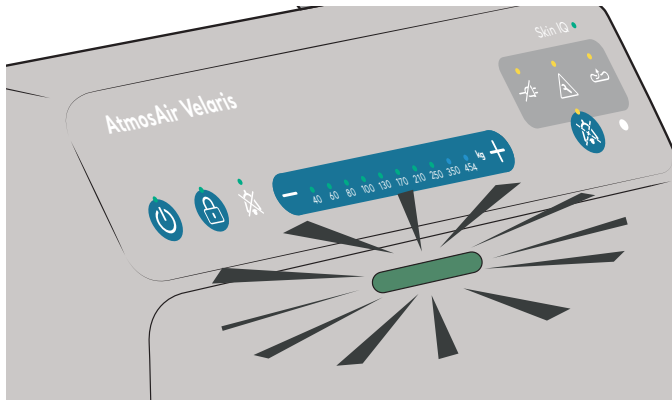

Figure 10

Repeater light

See Figure 10

During normal operation the repeater light is on and green.

During a fault condition, the repeater light will turn yellow.

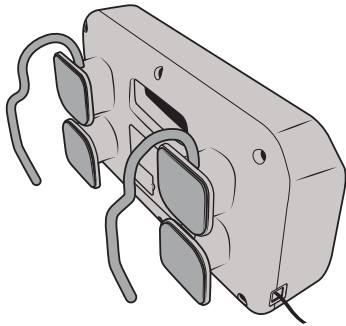

Figure 11

Hanging brackets

See Figure 11

Use the hanging brackets to mount the pump at the foot end of the bed.

The pump can also be placed on a flat surface near the bed and the mattress connector.

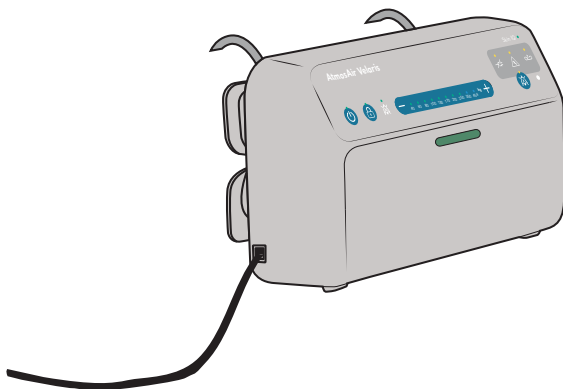

Figure 12

Power cable

See Figure 12

Position the power cable in the cable management loops on the left side of the mattress.

See Figure 22 on page 21.

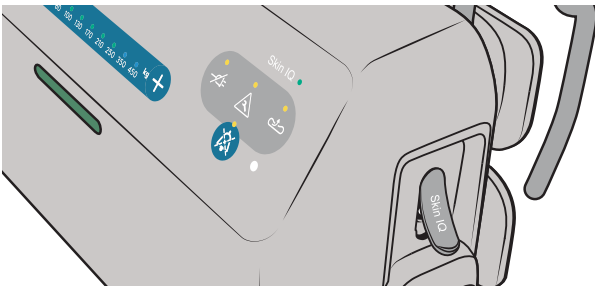

Figure 13

Skin IQ port

See Figure 13

Only use the Skin IQ port with the Skin IQ power cable to provide power to the Skin IQ coverlet. See Allowed combinations on page 39.

For instructions on how to use Skin IQ, see the Skin IQ IFU.

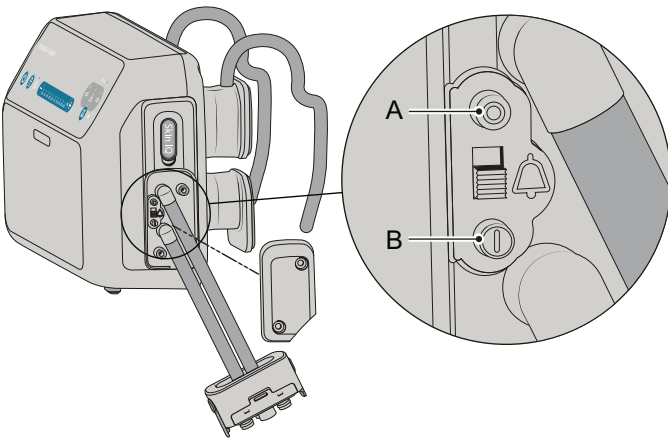

Figure 14

Audio on/off switch

See Figure 14

The Audio on/off switch disables all pump sound notifications. Use it when it has been determined that audio output could be disturbing for the patient.

The Audio on/off switch is located underneath the side panel cover. The cover can only be removed by a service technician.

Set the switch to position A to disable all audio output. Set the switch to position B to enable all audio output.

NOTE

The Audio on/off switch should only be used by qualified personnel under direction of the responsible organisation.

Day/Night mode

A light sensor automatically reduces the brightness of the pump lights in low ambient light.

Product description - Standard and Plus mattress

Covers

The mattress top and bottom welded covers are co-joined by a zip.

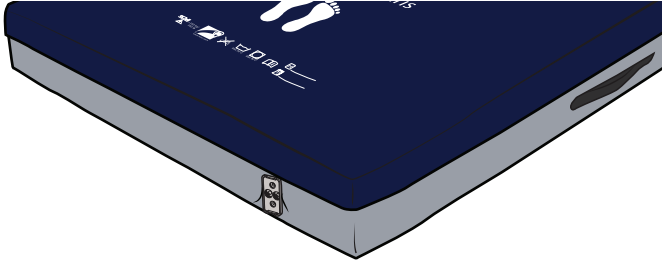

Figure 15

Mattress connector

The mattress connector is located at the foot end of the mattress. See Figure 15

The mattress connector is used to connect the mattress to the pump.

Connect the pump to the mattress

1. Locate the connector at the foot end of the mattress and pull it out of the pocket slightly. See Figure 16.
2. Hold the mattress connector in your left hand and press the connectors together. Make sure that the pump tube-set connector clicks into place on both sides (double-click). See Figure 17.
3. Push the connectors back into the cavity and reposition the zip flap. See Figure 18.

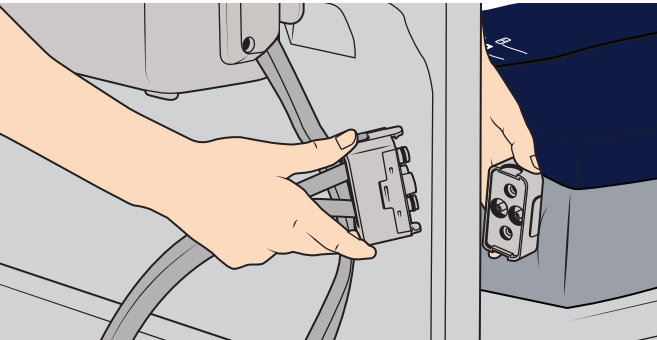

Figure 16

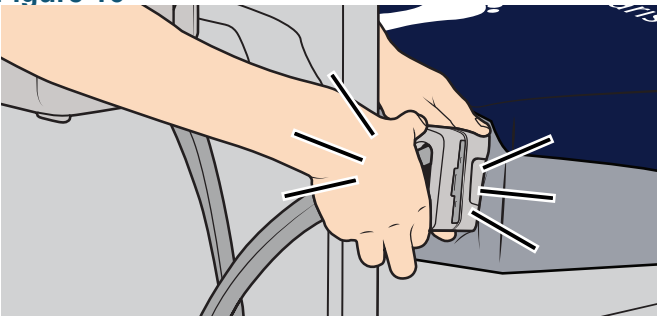

Figure 17



Figure 18

Disconnect the pump from the mattress

1. Locate the connector inside the connector cavity, near the foot end of the mattress. See Figure 19.

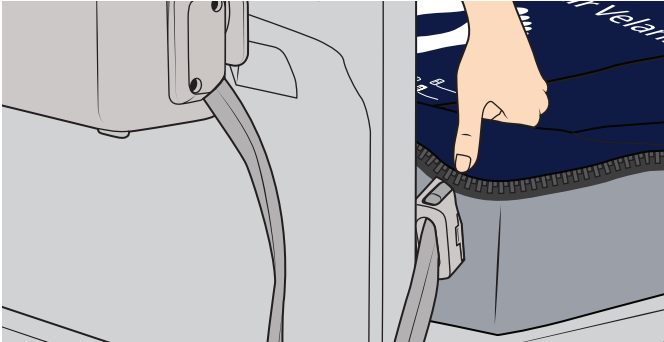

Figure 19

2. Firmly squeeze the two buttons on the top and bottom of the pump connector and pull it away from the mattress connector. See Figure 20.

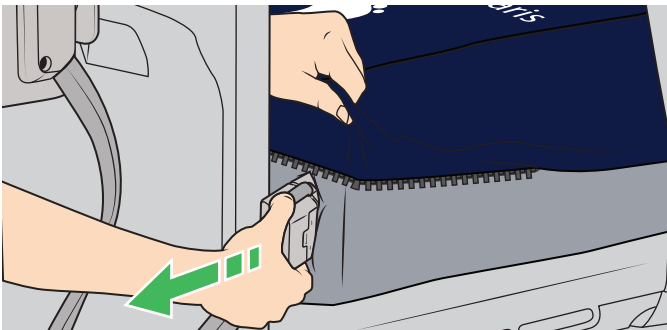

Figure 20

3. Push the mattress connector back into the connector cavity. See Figure 21.



Figure 21

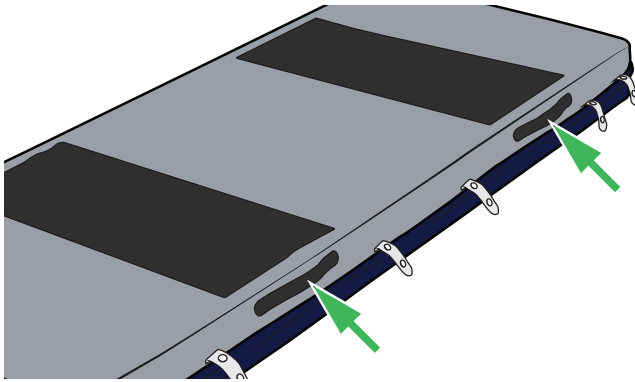

Figure 22

Handles

See Figure 22

WARNING

To avoid bodily injury, never use the mattress or ST mattress as a patient movement device.

To move the mattress use the four handles on the bottom mattress cover.

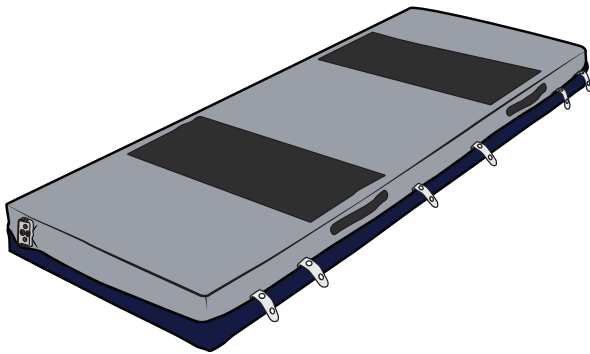

Figure 23

Non-slip base

See Figure 23

Non-slip strips integrated in the bottom cover prevent the mattress from slipping on the bed frame.

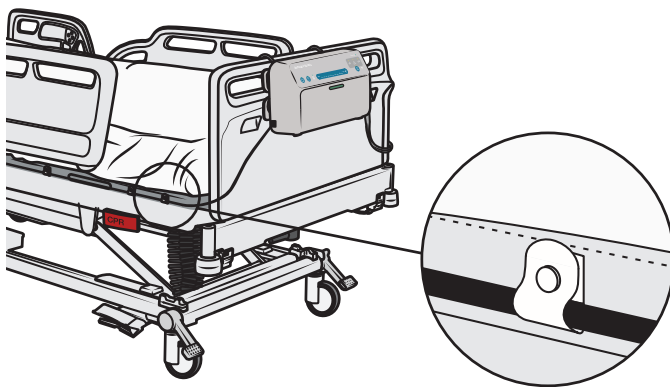

Figure 24

Cable management loops

See Figure 24

1. Place the power cable in the cable management loops on the left side of the bottom mattress cover.
2. Secure the cable using the six cable loops with locking clips.
3. Fold down the zip flap over the power cable and loops.

Product description - Stretcher (ST) mattress

Covers

The mattress top and bottom welded covers are co-joined by a zip.

Handles

See Figure 25

WARNING

To avoid bodily injury, never use the mattress or ST mattress as a patient movement device.

To move the mattress use the four handles on the bottom mattress cover.

Non-slip base

See Figure 26

Non-slip strips integrated in the bottom cover prevent the mattress from slipping on the trolley frame.

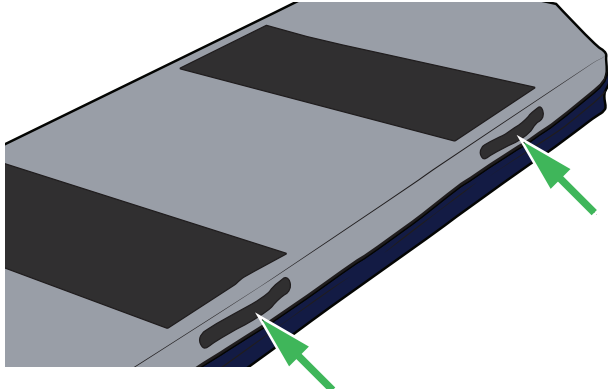

Figure 25

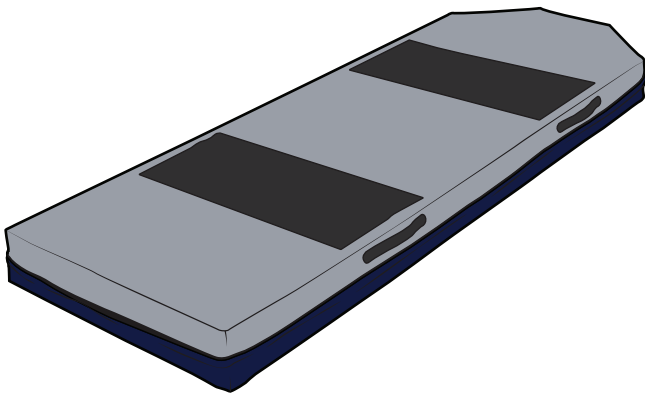

Figure 26

Product description - Seat cushion

Covers

The cushion top and bottom welded covers are co-joined by a zip.

Handle

See Figure 27

To move the seat cushion use the handle on the back.

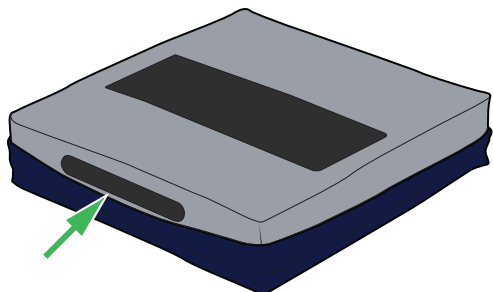

Figure 27

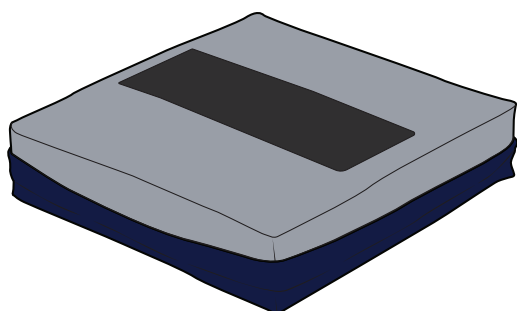

Figure 28

Non-slip base

See Figure 28

The non-slip strip integrated in the bottom cover prevents the cushion from slipping on the chair.

Assemble the hybrid mattress system

Assemble the Standard, Plus and ST mattresses

1. Remove any existing mattress from the bed/ trolley frame.
2. Check that there are no protruding sharp objects on the frame surface.

3.



WARNING

To avoid death or serious injury by entrapment, always select the correct mattress size for the bed/trolley.

Select the correct mattress size for the bed/trolley frame. Make sure that there are no gaps to trap the patient's head or body.

For mattress sizes see section Measurements and compatibility on page 40

4. For Standard or Plus mattress:

Position the mattress on the bed frame. Make sure that the mattress is orientated correctly with the mattress connector at the foot end of the bed frame. See Figure 29.

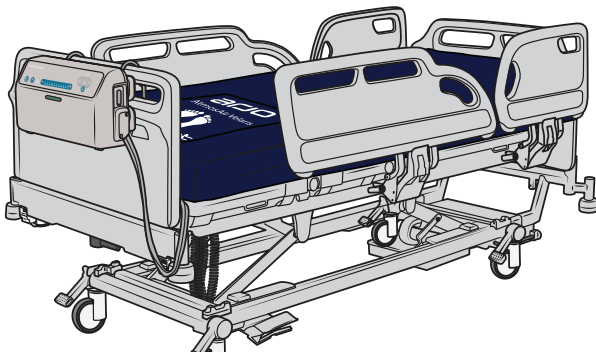

Figure 29

For ST mattress:

Position the mattress on the trolley frame. Make sure that the mattress is orientated correctly with the cut corners at the head end. See Figure 30.



Figure 30

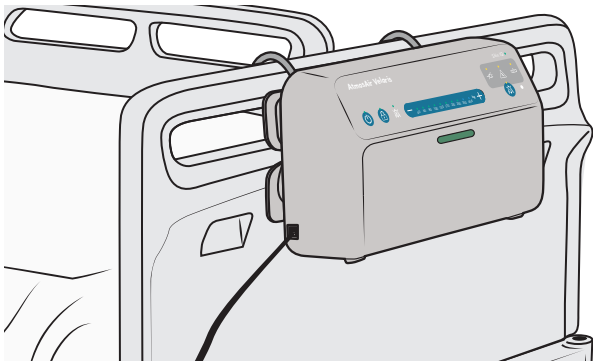

Figure 31

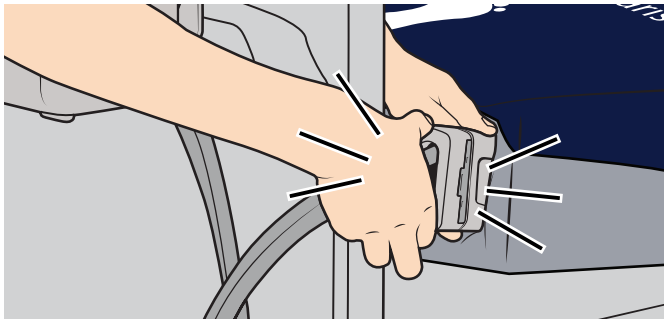

Figure 32

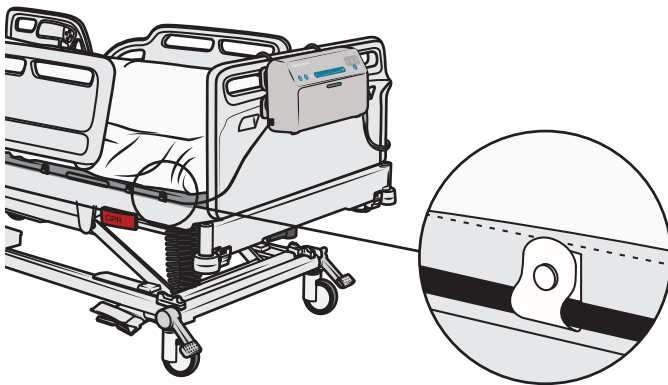

Figure 33

Assemble the Pump

1. Unwrap the power cable and tube-set from the pump cable management.
2. Hang the pump at the foot end of the bed. See Figure 31. Make sure that the pump is not:
 - near a heat source
 - in the sun
 - covered up
3. Check that the pump tube-set is not twisted.
4. Connect the pump tube-set connector to the mattress connector. Make sure that the pump tube-set connector clicks into place on both sides (double-click). See Figure 32.
5. Place the power cable in the cable management loops on the left side of the bottom mattress cover. Secure the cable using the six cable loops with locking clips. See Figure 33.
6. Fold down the zip flap over the power cable and loops.

Assemble Seat cushion

CAUTION

To avoid inadequate pressure redistribution, always use the seat cushion in the correct orientation.

CAUTION

To avoid puncturing the seat cushion, check that there are no sharp objects on the chair.

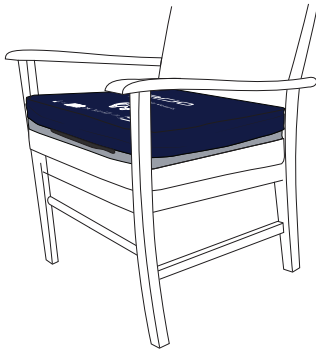

Figure 34

Place the seat cushion on top of the chair seat. Position the cushion with the symbol located at the front of the chair and the carrying handle at the back. See Figure 34.

Reactive therapy

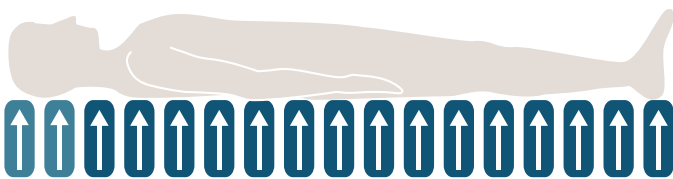

Figure 35

Make sure that the mattress is correctly installed on the bed / trolley frame before delivery of reactive therapy. See Assemble the hybrid mattress system on page 24.

See Figure 35.

Patient position

Place the patient on the mattress. Make sure that the patient's head is placed on the head end of the mattress.

Active therapy (Standard or Plus mattress)

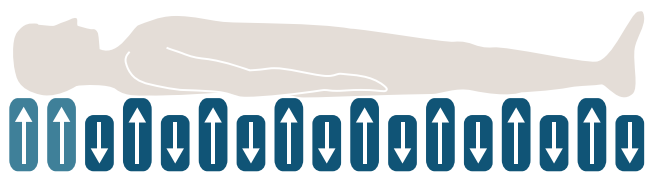

Figure 36

Before active (alternating) therapy make sure that the hybrid mattress system is assembled correctly with the alternating pressure pump attached. See Assemble the hybrid mattress system on page 24.

See Figure 36.

Patient position

Place the patient on the mattress. Make sure that the patient's head is placed on the head end of the mattress.

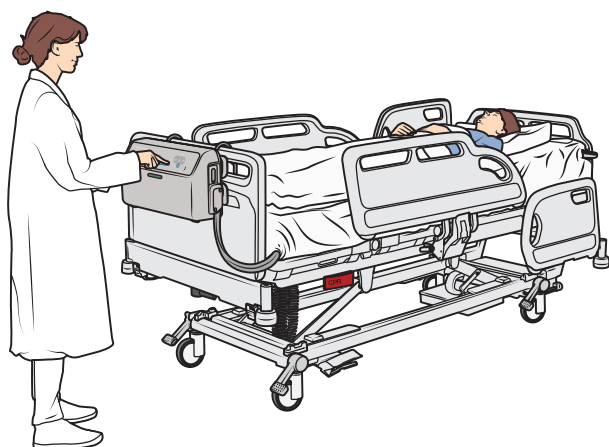

Figure 37

Caregiver position

The caregiver should be positioned in front of the pump during Active therapy. See Figure 37 .

System start-up

1. Connect the pump power cable to a power source. The pump makes a start up tone and runs a self diagnostic check for about 10 seconds.
2. When the check is completed, the pump immediately starts to deliver active (alternating) therapy with a default weight setting of 100kg (220 lb).
3. Press the - or + buttons to select the weight. Always round the patient's weight up to the next higher value.

Turn-off and remove the pump

1. To stop therapy press and hold the Run/Standby button for 2 seconds.
2. Unplug the power cable from the power source.
3. Disconnect the pump tube-set connector from the mattress connector. Firmly squeeze the two buttons on the top and bottom of the pump connector and pull it away from the mattress connector. See Figure 38.

NOTE

The mattress can continue to be used, as a reactive surface on the bed frame until active (alternating) therapy is needed, and the pump is reconnected

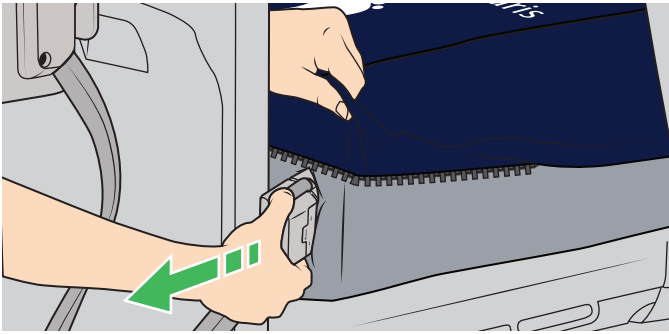

Figure 38

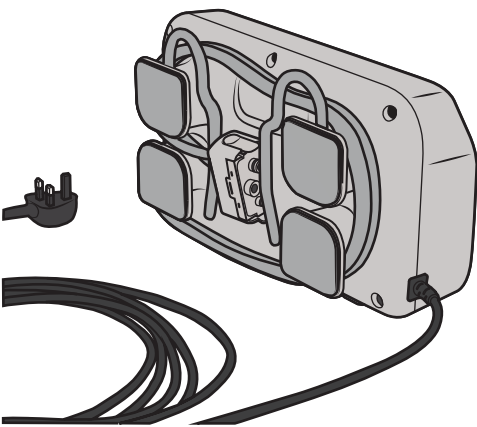

Figure 39

Store the pump

1. Clean and disinfect the pump. See section Cleaning and disinfection on page 30
2. Wrap the pump tube-set around the hanging brackets anticlockwise. See Figure 39.
3. Wrap the power cable around the hanging brackets clockwise. See Figure 40.
4. Store the pump in a designated area. For the storage requirements, see Transport and storage on page 39.

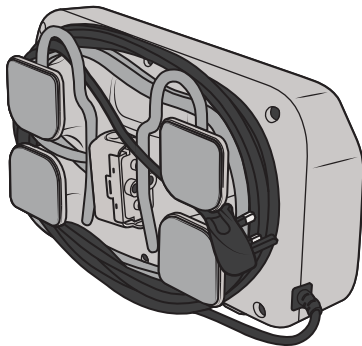

Figure 40

Homecare use

WARNING

To avoid injury to the patient when operating the hybrid mattress system as a caregiver and as a lay person:

- Make sure that the device is operating according to section Reactive therapy on page 26 or Active therapy (Standard or Plus mattress) on page 27.
- If the device is not operating correctly, see section Troubleshooting and alarms on page 37.
- If the device is still not operating correctly, or if you have concerns, contact the patient's doctor or nursing staff for advice.

WARNING

To avoid risk of entanglement, never leave children or vulnerable persons unattended with the device

WARNING

To avoid injury to the patient, keep children and pets away from the device.

WARNING

To avoid suffocation, keep the bags supplied with this device away from babies and small children.

WARNING

To avoid choking, never leave children unattended near the device. The device includes small parts that may present a choking hazard to small children, vulnerable persons and pets if inhaled or swallowed.

CAUTION

To avoid damage to the device, pets and children must be supervised in the vicinity of the hybrid mattress system.

Before using the AtmosAir Velaris hybrid mattress system in a home environment, make sure that all caregivers, including relatives, have read and understood the instructions in this IFU.

When the hybrid mattress system is in use, make sure that:

- It is kept away from sources of heat and moisture, and protected from dust, lint and dirt.
- The pump is not covered.
- The operational environment meets the requirements. See section Operating conditions on page 38

When the hybrid mattress system is not in use, make sure that:

- No children can access it.
- No pets can come into contact with it.
- The storage environment meets the requirements. See section Transport and storage on page 39

Cleaning and disinfection

The hybrid mattress system should be cleaned and disinfected at regular intervals and between patients. Follow your local practices for all reusable medical devices.

Contact Arjo Customer Service for any questions regarding the cleaning and disinfection of the device. Make sure that the Safety Data Sheet (SDS) is available for the disinfectant used.

WARNING

To avoid eye and skin damage, always use protective glasses and protective gloves. If contact occurs, rinse with plenty of water. If eyes or skin become irritated, contact a physician.

Always read the material safety data sheet of the disinfectant.

WARNING

To avoid electrical shock, always disconnect the pump from the power source before cleaning and inspecting.

WARNING

To prevent cross-contamination, always follow the disinfection instructions in this IFU.

WARNING

To avoid eye or skin irritation, never disinfect in the presence of a patient.

CAUTION

To avoid equipment damage:

- Do not use Phenol-based solutions or abrasive compounds or pads during the disinfection process as these damage the surface coating.
- Do not spray cleaning solutions directly onto the pump.
- Do not autoclave or boil any part of the hybrid mattress system. Avoid immersing electrical parts in water.

Allowed disinfectants

DISINFECTANT	HYBRID MATTRESS SYSTEM	TOP COVER	BOTTOM COVER	RECOMMENDATIONS FOR USE
Alcohol solution ≤ 70%	●	●	●	Coating may swell when wet hence care must be taken to avoid accidental scratches and fold only when dry before storage.
Chlorine solution ≤ 1% (10,000 ppm) ¹	●	●	●	Acceptable use at pH 7-9. Must be towel dried (avoid harsh abrasion) after rinsing with clean water.
Quaternary ammonium solution 1920ppm	●	●	●	Acceptable for use at pH 7-10 only. Always check the label first. DO NOT USE WIPES containing Sodium Hydroxide (NaOH). Fully rinse with clean water to remove residual chemicals
Quaternary ammonium solution, 3-15%		●	●	Acceptable for use at pH 7-10 only. Always check the label first. DO NOT USE WIPES containing Sodium Hydroxide (NaOH). Fully rinse with clean water to remove residual chemicals.
Hydrogen peroxide solution, 3-10%.		●		Acceptable for use at pH 5-9 only. Low and high pH's will DAMAGE the coating. Fully rinse with water to remove any acid or alkali.

¹ Chlorine concentrations may vary from 250 ppm to 10,000 ppm depending on local policy and contamination status.

NOTE

Rinse and dry thoroughly with clean water to remove residual chemicals after disinfecting with each chemical before storage

Accessories needed for cleaning/ disinfection

- Protective glasses
- Protective gloves
- Spray bottle with cleaning solution
- Spray bottle with disinfectant solution
- Spray bottle with water
- Cloths



Clean and disinfect

(26 steps)

Always follow these steps for proper cleaning and disinfection after each patient.

Prepare the pump

1. Disconnect the pump from the mattress.
2. Select Standby on the pump unit. Disconnect the pump from the power source.

Clean the pump

3. Put on protective glasses and gloves.
4. Spray the cleaning solution on a clean cloth.
5. Wipe all areas of the pump to remove any deposits or visible dirt.
6. Clean all areas with residual dirt with the cloth as needed.
7. Use a new cloth soaked in water to wipe off all traces of cleaning solution.
8. Use a dry cloth to remove any excess moisture from the pump.

Disinfect the pump

9. Spray disinfectant solution on a clean cloth and wipe all areas of the pump.
10. Allow time for disinfection according to the instructions provided by the disinfectant manufacturer.
11. Use a new cloth soaked in water to wipe off all traces of disinfectant solution from the pump.
12. Use a dry cloth to remove any excess moisture from the pump.
13. Allow the pump to air dry.

Instructions continue on the next page

Clean the mattress / seat cushion covers

NOTE

The top cover should be assessed for the level of soiling. If this soiling is deemed excessive, the top cover should be washed. The bottom cover should always be cleaned and disinfected by wiping.

14. Spray cleaning solution on a clean cloth and wipe all external areas and handles of the mattress / seat cushion top and bottom covers. Make sure to wipe the mattress connector and the connector cavity thoroughly. Wipe off any dirt with a clean cloth.
15. Clean areas with residual dirt (e.g. handles) with the cleaning solution as needed.
16. Use a new cloth soaked in water to wipe off all traces of cleaning solution
17. Use a dry cloth to remove any excess moisture.

Disinfect the mattress / seat cushion covers

18. Spray disinfectant solution on a clean cloth and wipe all external areas and handles of the mattress / seat cushion top and bottom covers. Make sure to wipe the mattress connector and the connector cavity thoroughly.
19. Allow time for disinfection according to the instructions provided by the disinfectant manufacturer.
20. Use a new cloth soaked in water to wipe off all traces of disinfectant solution from the mattress / seat cushion.
21. Use a dry cloth to remove any excess moisture.
22. Allow the mattress / seat cushion top and bottom covers to air dry.

Wash the mattress / seat cushion top cover

23. Unzip and remove the top cover from the mattress / seat cushion.
24. Launder the top cover at a maximum temperature of 80°C (176°F) with detergent.
25. After washing, allow the top cover to air dry (preferred) or tumble dry at 40°C (104°F) or up to 80°C (176°F) maximum.
26. Once dry refit the top cover to the mattress / seat cushion.

Care and preventive maintenance

Under normal use the hybrid mattress system is subject to wear and tear. Perform the following actions when specified to make sure that the product remains within its original manufacturing specifications.



WARNING

To avoid malfunction resulting in injury, inspect your device regularly. Always follow the recommended maintenance schedule.



WARNING

To avoid injury and/or an unsafe product, the pump's case must only be removed by qualified service personnel. There are no user-serviceable parts inside the pump, mattress or seat cushion. No modification of this device is allowed.



WARNING

To avoid injury and/or an unsafe product, the device must be properly serviced at the correct frequency. All qualified service personnel must have documented training in the maintenance of this device and use the correct tools, parts and know-how.

CAREGIVER OBLIGATION	BEFORE EVERY USE OR EVERY WEEK	AFTER EACH PATIENT
Perform a full functionality test on the hybrid mattress system	●	
Visually check the control panel	●	
Visually check all electrical connections and power cable	●	
Visually check the mattress connector	●	
Visually check the pump tube-set and connector	●	
Visually check the top and bottom covers	●	
Clean and disinfect		●
Visually check all labels		●
Visually check all zips		●

Caregiver obligations - before every use or every week

NOTE

If any part is damaged or missing DO NOT use the product.

Perform a full functionality test on the hybrid mattress system

1. Connect the pump tube-set to the Standard or Plus mattress. Make sure that the tube-set clicks into place.
2. Connect the pump power cable to a power source. The pump makes a start up tone and runs a self diagnostic check for about 10 seconds.
3. When the check is completed, the pump Run/Standby and front panel repeater lights turn on. The hybrid mattress system starts delivering active (alternating) therapy with a default weight setting of 100kg (220 lb).
4. If the functionality test fails, contact qualified service personnel

Visually check the control panel

- Check that the control panel is firmly affixed.
- Check that the control panel is undamaged.
- Check that the control panel is legible.

Visually check all electrical connections and power cable

- Check all electrical connections for signs of excessive wear or damage.
- Check the power cable for signs of excessive wear or damage.

Visually check the mattress connector

- Check the connector for signs of excessive wear or damage.

Visually check the pump tube-set and connector

- Check the tube-set for signs of excessive wear or damage.
- Check the connector for signs of excessive wear or damage.

Visually check the top and bottom covers

- Remove the top cover and check for signs of wear, tears or strike-through (stained firesock).
- Inspect the bottom cover for signs of wear and tears

Caregiver obligations - after each patient

Clean and disinfect

The hybrid mattress system has to be cleaned and disinfected. For further instructions see section Cleaning and disinfection on page 30.

Visually check all labels







Check that all labels are attached on the hybrid mattress system according to section Labels on page 42. If any label is missing, contact Arjo Customer Service.

Visually check all zips

- Check that all zips are undamaged and not loose.
- Check that the zip puller is not missing.

Troubleshooting and alarms

The LOW PRESSURE and HARDWARE FAIL alarms are low priority alarms. The POWER FAIL light is an information signal.

LIGHT	POSSIBLE CAUSE	SOLUTION	ALARM ACTIVATION DELAY
<p>LOW PRESSURE</p>  <p>Repeater light on</p>	<ul style="list-style-type: none"> The mattress to pump connector is not correctly connected. There is a leak in the pneumatic system 	<ol style="list-style-type: none"> Check that the tube-set connector is correctly connected to the pump - an audible click should be heard. Contact qualified service personnel. 	Maximum 25 minutes for mattress
<p>POWER FAIL</p>  <p>All other lights are off</p>	<ul style="list-style-type: none"> Power source removed, switched off or disconnected Power outage 	<ol style="list-style-type: none"> Switch power source back on or reconnect. Wait for power to be restored. Press and hold the run/standby button to cancel the alarm 	Immediate
<p>HARDWARE FAIL</p>  <p>Repeater light on</p>	<ul style="list-style-type: none"> On initial power up During Normal operation, after successful start-up. 	<ol style="list-style-type: none"> Internal hardware fault, replace pump Select Standby, remove power source. Re-power and if pump fails BIST replace pump. 	10 Seconds after power-up At any time during normal operation
<p>LOCK MODE</p> 	The pump has been put into Lock mode.	Press and hold the lock button for more than 2 seconds. The lock button light is off and all buttons are unlocked	
<p>AUDIO ALARM PAUSE</p> 	The pump audio alarm has been paused during LOW PRESSURE OR HARDWARE FAIL condition.	If the fault condition clears, the audio alarm pause is reset and the light is off. After 15 minutes, the audio alarm pause will reset and the light is off. If the fault condition persists, the audio alarm sounds again.	Max 15 minutes
<p>AUDIO OFF</p> 	During a fault condition, if there is no audio alarm and the AUDIO OFF light is lit. The audio on/off switch is set to off position.	If it is required for Audio alarms and notifications to be activated a qualified technician can set the Audio on/off switch to ON.	
<p>SKIN IQ</p> 	The Skin IQ is connected but blower is not operational.	Replace Skin IQ coverlet. Replace control PCBA.	

Technical specifications

GENERAL - PUMP	
Model:	AtmosAir Velaris
Case material:	PC ABS
Part number:	633xxx (xxx is determined by the type of mains lead fitted. Please refer to rear label for actual part number)
Size:	337 x 107 x 200 mm (13.3 x 4.2 x 7.9 in)
Weight:	4.1 kg (9 lb)
Plug Fuse Rating:	5A to BS1362 (UK only)
Degree of protection against electric shock:	Mains Connected: Class II, Double Insulated without Functional Earth Type BF
Degree of protection against liquid ingress:	IP22. Protected from touch by fingers and objects greater than 12 millimetres. Protected from water spray less than 15 degrees from vertical.
Mode of operation:	Continuous
Alternating Mode Cycle Time:	10 minutes

ELECTRICAL	
Supply voltage:	100-230 V
Supply frequency:	50-60 Hz
Power input:	3-46 VA

OPERATING CONDITIONS	
Temperature (Ambient):	5 °C to 40 °C (41 °F to 104 °F)
Relative humidity range:	15 % to 90 % (non-condensing)
Atmospheric pressure:	700 hPa to 1060 hPa
If the pump is stored in conditions outside the operating ranges, allow time for its temperature to stabilise at room temperature before use. Allow a minimum of 8 hours if the pump is stored at -20 °C (-4 °F) or 60 °C (140 °F).	

TRANSPORT AND STORAGE

Short term (Up to 30 days):

Temperature (Ambient)	-20 °C to 60 °C (-4 °F to 140 °F)
Relative humidity range	0 % to 95 %

Long term (> 30 days):

Temperature (Ambient)	0 °C to 40 °C (32 °F to 104 °F)
Relative humidity range	0 % to 95 % (non-condensing)

CAUTION

To avoid damage to the hybrid mattress system:

- Do not store in direct sunlight.
- Store the pump and mattress in the protective bags supplied.
- Clean and disinfect the pump and mattress before storage.

EXPECTED SERVICE LIFE

AtmosAir Velaris pump	7 years
-----------------------	---------

END OF LIFE DISPOSAL

Package	Corrugated cardboard, recyclable.
Product	<ul style="list-style-type: none"> • Fabric material used on the mattresses or any other textiles, polymers or plastic materials etc. should be sorted as combustible waste. • Mattresses at the end of life should be disposed of as waste according to the national or local requirements, which may be landfill or combustion. • Pump units have electrical and electronic components and should be disassembled and recycled per waste of Electrical and Electronic Equipment (WEEE) or in accordance with local or national regulation.

ALLOWED COMBINATIONS

AtmosAir Velaris Standard	<ul style="list-style-type: none"> • Skin IQ® MCM, Coverlet Only • Skin IQ® 365, Coverlet Only
AtmosAir Velaris Plus	<ul style="list-style-type: none"> • Skin IQ® 1000, Coverlet Only

MEASUREMENTS AND COMPATIBILITY

Standard mattress

Part no	Size mm (in)	Top cover material	Weight kg (lb)	Arjo bed frames
633048	810 X 2000 X 180 (32 x 79 x 7)	Reliant	15 (33)	
633049		Premium		
633020	860 x 1980 x 180 (34 X 78 X 7)	Reliant	15.5 (34)	Contoura 460/480, Minuet 2, Prioma
633026		Premium		
633021	880 x 2020 x 180 (35 X 80 X 7)	Reliant	15.5 (34)	Contoura C880, Enterprise 5000, 8000, 9000, Citadel
633027		Premium		
633022	880 x 2140 x 180 (35 x 84 x 7)	Reliant	16.5 (36)	Enterprise 5000, 8000, 9000 (Extended), Citadel (Extended)
633028		Premium		
633023	900 x 2000 x 180 (35 x 79 x 7)	Reliant	16,5 (36)	
633029		Premium		
633024	1070 x 2000 x 180 (42 x 79 x 7)	Reliant	17,5 (39)	
633030		Premium		

Plus mattress

Part no	Size mm (in)	Top cover material	Weight kg (lb)	Arjo bed frames
633025	1220 x 2140 x 180 (48 x 84 x 7)	Reliant	24 (53)	Citadel Plus
633031		Premium		

ST mattress

Part no	Size mm (in)	Top cover material	Weight kg (lb)	Arjo Trolley
633042	670 x 1950 x 130 (26 x 77 x 5)	Reliant	10 (22)	Lifeguard Trolley
633043		Premium		
633044	660 x 1910 x 130 (26x 75 x 5)	Reliant	9 (20)	
633045		Premium		
633046	762 x 1910 x 130 (30 x 75 x 5)	Reliant	10 (22)	
633047		Premium		

Seat cushion

Part no	Size mm (in)	Top cover material	Weight kg (lb)	Arjo seats
633016	432 x 432 x 100 (17 x 17 x 4)	Reliant	1.5 (3)	Standard size
633018	432 x 432 x 100 (17 x 17 x 4)	Premium	1.5 (3)	Standard size
633017	457 x 457 x 100 (18 x 18 x 4)	Reliant	1.5 (3)	Large Size
633019	457 x 457 x 100 (18 x 18 x 4)	Premium	1.5 (3)	Large Size

TOP COVER SPECIFICATION		
Feature	Reliant cover	Premium cover
Removable Cover	Yes	Yes
Moisture Vapour Permeable MVTR - Index method BS3424-34	10%	4%
Polyurethane coating includes an antimicrobial agent to control microbial deterioration of fabric	Yes	Yes
Fire Retardant ¹	BS 7175: 0, 1 & 5	BS 7175: 0, 1 & 5
Material stretch properties	4-way	4-way
Recommended wash Temperatures	80°C (176°F) 15 minutes	80°C (176°F) 15 minutes
Recommended Drying Temperatures	40°C (104°F) or air dry	40°C (104°F) or air dry
Maximum Drying Temperatures	Max 80°C (176°F)	Max 80 °C (176 °F)
Wipe-down Chemicals ²	<ul style="list-style-type: none"> Chlorine at strength of ≤1% (10,000 ppm) at pH 7-9 Quaternary Ammonium Chloride at 1920ppm at pH 7-10 Alcohol at 70% concentration. Phenolic solutions are NOT recommended/suitable. <p>Always rinse thoroughly with clean water after disinfection and dry before storage. Alcohol does not require rinsing with water.</p> <p>Further following disinfecting agents are also considered to be acceptable by the TOP COVER material manufacturer</p> <ul style="list-style-type: none"> Quaternary Ammonium solution 3-15% at pH range 7-10 see Allowed disinfectants on page 31 for recommendations. Hydrogen Peroxide solution 3-10% at pH 5-9 see Allowed disinfectants on page 31 for recommendations.. <p>Always allow time for disinfection according to the instructions provided by the disinfectant manufacturer.</p>	
Lifetime Expectancy	Standard	Increased by x2.5 times longer when tested with accelerated aging (ISO 1419:1995)
Abrasion resistance	130 000 cycles	260 000 cycles (minimum)

¹ For additional flammability testing standards, refer to individual product law tags, if applicable.

² Chlorine concentrations may vary from 250 ppm to 10,000 ppm depending on local policy and contamination status. If an alternative disinfectant is selected from the wide variety available, Arjo recommend that suitability for use be confirmed with the chemical supplier prior to use

Labels





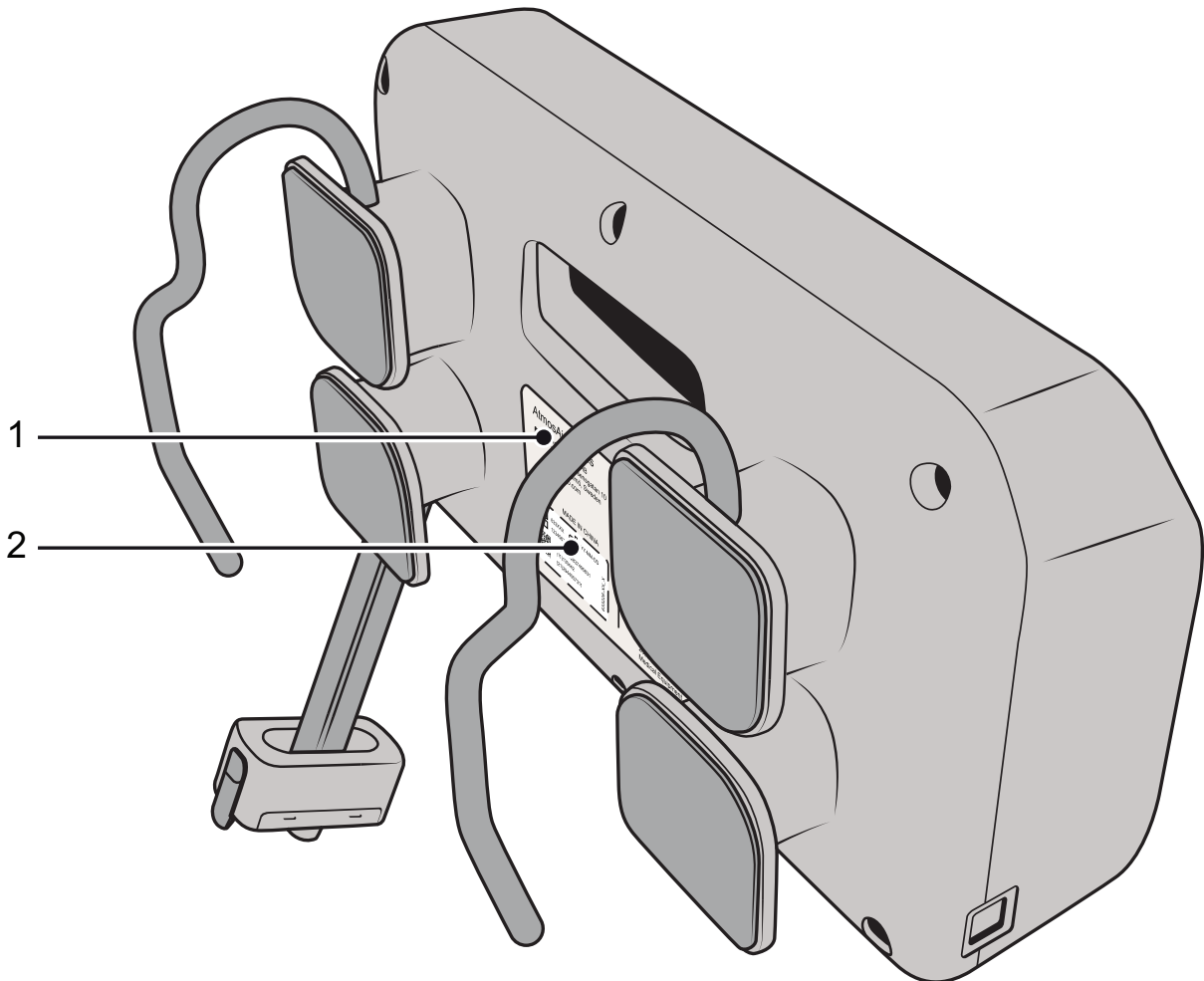









Labels on the Pump

LABEL EXPLANATION	
Product label	States technical performance and requirements, e.g. input power and input voltage.
Serial number label	States the item identification

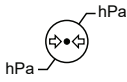

1. Product label
2. Serial number label

SYMBOL EXPLANATION

	Read the Instructions for use before use.
	CE marking indicating conformity with European Community harmonised legislation. Figures indicate Notified Body supervision.
	Indicates the product is a Medical Device according to EU Medical Device Regulation 2017/745.
	With respect to electric shock, fire and mechanical hazards only in accordance with CAN/CSA-C22.2 No.60601.1 (2008) + (2014) and ANSI/ AAMI ES60601-1 (2005)+AMD(2012). MEDICAL EQUIPMENT
	Serial number
	Reference number
	Name and address of the manufacturer
	Manufacturing date
	Separate electrical and electronic components for recycling in accordance with the European Directive 2012/19/EU (WEEE)
	Type BF, Applied part: protection against electrical shock in accordance with IEC 60601-1.
	Double Insulated
	Temperature limitation To indicate the temperature limitations for the product during usage
	Atmospheric pressure limitation To indicate the acceptable upper and lower limits of atmospheric pressure for the product during usage
	Humidity limitation To indicate the acceptable upper and lower limits of relative humidity for the product during usage

Labels on the surfaces

LABEL EXPLANATION	
Top cover label	States the top cover identification and maximum patient weight
Surface ID Label	States the product identification and product weight
Law tag	States certification of flammability test



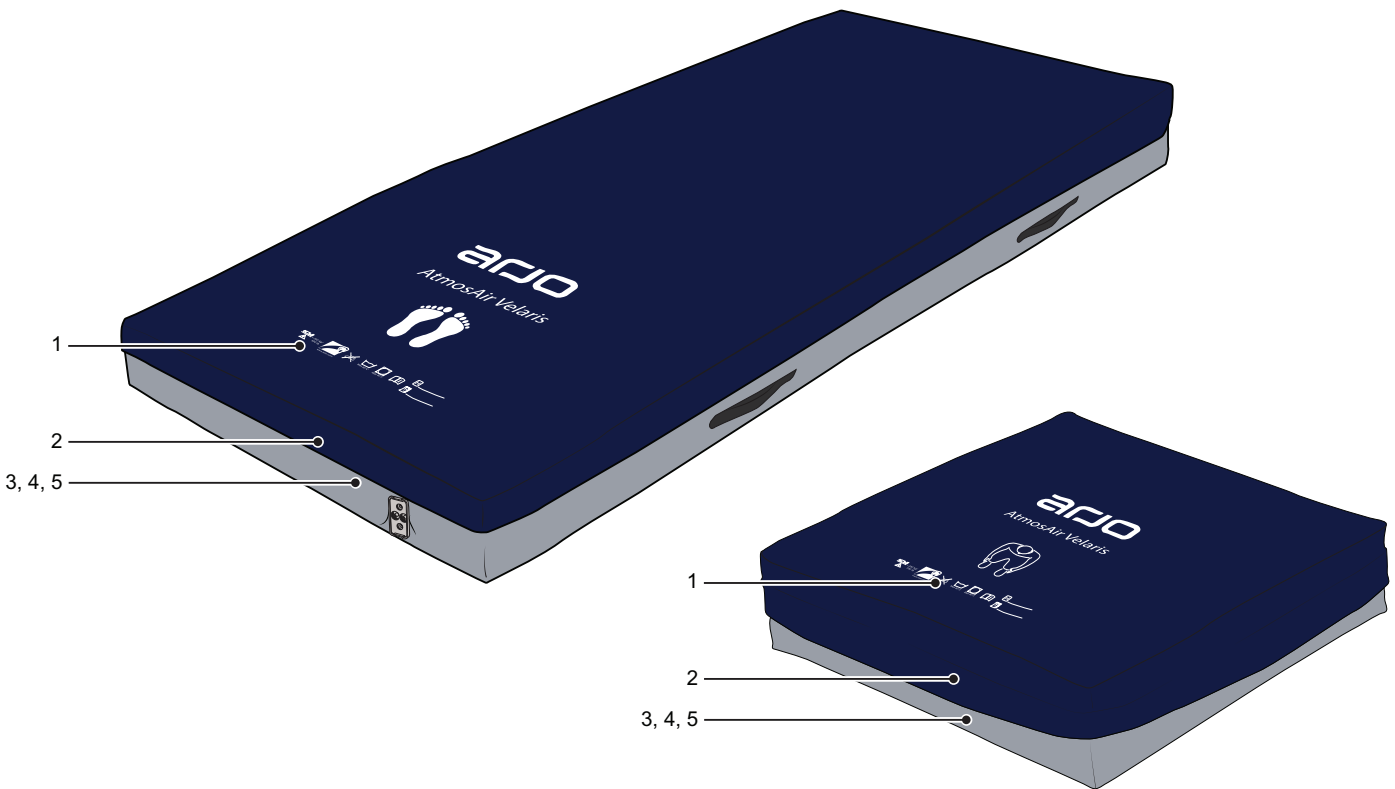













Example of mattress

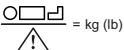

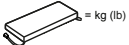
1. Silkscreens
2. Top cover label (inside the top cover)
3. Surface ID label (inside the bottom cover)

4. US law tag (inside the bottom cover)
5. Canadian law tag (inside the bottom cover)

SYMBOL EXPLANATION

	Read the Instructions for use before use.
	CE marking indicating conformity with European Community harmonized legislation.
	Indicates the product is a Medical Device according to EU Medical Device Regulation 2017/745.
	Lot number
	Serial number
	Reference number
	Name and address of the manufacturer
	Manufacturing date
	Safe working load defines the maximum total load of the patient kg (lb) (mattresses)
	Safe working load defines the maximum total load of the patient kg (lb) (seat cushion)
	Product weight (surface)
	Recommended wash temperature: 15 min at 80 °C (176 °F)
	Tumble dry at 80 °C (176 °F)
	Do not iron
	Wipe surfaces with cleaning solution, then wipe with a cloth moistened with water and dry
	Identifies the facility and ward where the surface is used
	The date when the surface was fitted to current bed frame or seat.

List of standards and certificates

STANDARD / CERTIFICATE	DESCRIPTION
IEC 60601-1:2005 + AMD1:2012 + AMD2:2020 (Ed 3.2)	Medical Electrical Equipment – Part 1: general requirements for basic safety and essential performance.
IEC 60601-1-11:2015 + AMD1:2020 (Ed 2.1)	Medical Electrical Equipment – Part 1-11: general requirements for basic safety and essential performance – Collateral Standard: Requirements for medical electrical equipment and medical electrical systems used in the home healthcare environment
IEC 60601-1-2:2020 (ed. 4.1)	Medical electrical equipment - Part 1-2: general requirements for basic safety and essential performance - Collateral Standard: Electromagnetic disturbances
IEC 60601-1-8:2006 + AMD1:2012 + AMD2:2020 (Ed 2.2)	<p>Medical Electrical Equipment Part 1-8 general requirement for basic safety and electrical performance</p> <p>- Collateral standard: general requirements, tests and guidance for alarm systems in medical electrical equipment and medical electrical systems</p>

Electromagnetic compatibility

The hybrid mattress system is intended for use in the electromagnetic environment specified below. The customer or the user of the hybrid mattress system should make sure that it is used in such an environment.

Electromagnetic Compatibility (EMC)

This product complies with the requirements of applicable EMC Standards. Medical electrical equipment needs special precautions regarding EMC and needs to be installed in accordance with the following instructions:

- The use of accessories not specified by the manufacturer may result in decreased immunity of the product, or increased emissions from the product. This would affect the products performance.
- Portable and mobile radio frequency (RF) communications equipment (e.g. mobile/cell phones) can affect medical electrical equipment.
- If this equipment needs to be used adjacent to other electrical equipment, normal operation must be checked before use.

For detailed EMC information contact Arjo service personnel.



WARNING

Stacking or placing other electrical equipment next to this device is not recommended, it can interfere with the equipment's operation and safety. Portable and mobile radio frequency (RF) communications equipment can interfere with this device operation and safety.



WARNING

The equipment may cause radio interference or may disrupt the operation of nearby device. It may be necessary to take action, such as reorienting, relocating the device or shielding the location.

GUIDANCE AND MANUFACTURER'S DECLARATION – ELECTROMAGNETIC EMISSION

The pump is intended for use in the electromagnetic environment specified below. The customer or the user of the pump should ensure that it is used in such an environment.

Emissions test	Compliance	Electromagnetic environment - guidance
RF emissions	Group 1	The pump uses RF energy only for its internal function. Therefore, its RF emissions are very low and are not likely to cause any interference in nearby electronic equipment.
RF emissions	Class B	This pump is suitable for use in all establishments including domestic and those directly connected to the public low voltage power supply network.
Harmonic emissions IEC 61000-3-2	Class A	
Voltage fluctuations/ flicker emissions IEC 61000-3-3	Complies	

GUIDANCE AND MANUFACTURER'S DECLARATION - ELECTROMAGNETIC IMMUNITY

The pump is intended for use in the electromagnetic environment specified below. The customer or the user of the pump should ensure that it is used in such an environment.

Immunity test	IEC 60601 test level	Compliance level	Electromagnetic environment - guidance
Conducted RF IEC 61000-4-6	3Vrms 6Vrms ISM, 150KHz- 80MHz 80 % AM 1KHz	10Vrms 150KHz- 2300MHz	Portable and mobile RF communications equipment should be used no closer to any part of the pump, including cables, than the recommended separation distance calculated from the equation applicable to the frequency of the transmitter. Recommended separation distance $d = 1.2\sqrt{P}$ 150kHz~80MHz $d = 1.2\sqrt{P}$ 80MHz~800MHz $d = 2.3\sqrt{P}$ 800MHz~2.7GHz Where P is the maximum output power rating of the transmitter in watts (w) according to the transmitter manufacturer and d is the recommended separation distance in metres (m). Field strengths from fixed RF transmitters, as determined by an electromagnetic site survey ^a , should be less than the compliance level in each frequency range. ^b Interference may occur in the vicinity of equipment marked with the following symbol: 
Radiated RF IEC 61000-4-3	10 V/m 80 MHz to 2.7 GHz	10 V/m	

Note: At 80 MHz and 800 MHz, the separation distance for the higher frequency range applies.

Note: These guidelines may not apply in all situations. Electromagnetic propagation is affected by absorption and reflection from structures, objects and people.

^a Field strengths from fixed transmitters, such as base stations for radio (cellular/cordless) telephones and land mobile radios, amateur radio, AM and FM radio broadcast and TV broadcast cannot be predicted theoretically with accuracy. To assess the electromagnetic environment due to fixed RF transmitters, an electromagnetic site survey should be considered. If the measured field strength in the location in which the pump is used exceeds the applicable RF compliance level above, the pump should be observed to verify normal operation. If abnormal operation is observed, additional measures may be necessary, such as re-orientating or relocating the pump.

^b Over the frequency range 150 kHz to 80 MHz, field strengths should be less than 3 V/m.

RECOMMENDED SEPARATION DISTANCES BETWEEN PORTABLE AND MOBILE RF COMMUNICATION EQUIPMENT AND THE PUMP

The pump is intended for use in an electromagnetic environment in which radiated RF disturbances are controlled. The customer or the user of the pump can help prevent electromagnetic interference by maintaining a minimum distance between portable and mobile RF communications equipment (transmitters) and the pump as recommended below, according to the maximum output power of the communications equipment.

Rated maximum output power of transmitter - W	Separation distance according to frequency of transmitter - m		
	150 kHz to 80 MHz $d = 1.2\sqrt{P}$	80 MHz to 800 MHz $d = 1.2\sqrt{P}$	800 MHz to 2.7 GHz $d = 2.3\sqrt{P}$
0.01	0.12	0.12	0.23
0.1	0.38	0.38	0.73
1	1.2	1.2	2.3
10	2.8	3.8	7.3
100	12	12	23

For transmitters rated at a maximum output power not listed above, the recommended separation distance d in metres (m) can be estimated using the equation applicable to the frequency of the transmitter, where P is the maximum output power rating of the transmitter in watts (w) according to the transmitter manufacturer.

Note: At 80 MHz and 800 MHz, the separation distance for the higher frequency range applies. Note: These guidelines may not apply in all situations. Electromagnetic propagation is affected by absorption and reflection from structures, objects and people.

GUIDANCE AND MANUFACTURER'S DECLARATION - ELECTROMAGNETIC IMMUNITY

The pump is intended for use in the electromagnetic environment specified below. The customer or the user of the pump should ensure that it is used in such an environment.

Immunity test	IEC 60601 test level	Compliance level	Electromagnetic environment – guidance
Electrostatic discharge (ESD) IEC 61000-4-2	± 8 kV contact ± 15 kV air	± 8 kV contact ± 15 kV air	Floors should be wood, concrete or ceramic tile. If floors are covered with synthetic material, the relative humidity should be at least 30 %.
Electrical fast transient/ bursts IEC 61000-4-4	± 2 kV for power supply lines ± 1 kV for input/output lines	± 2 kV for power supply lines input/output lines not applicable	Mains power quality should be that of a typical domestic commercial or hospital environment.
Surge IEC 61000-4-5	± 1 kV line(s) to line(s)	± 1 kV line(s) to line(s)	Mains power quality should be that of a typical domestic commercial or hospital environment.
Voltage dips, short interruptions and voltage variations on power supply input lines IEC 61000-4-11	<5 % μ T (>95 % dip in μ T) for 0.5 cycle 40 % μ T (60 % dip in μ T) for 5 cycle 70 % μ T (30 % dip in μ T) for 25 cycles <5 % μ T (>95 % dip in μ T) for 5 s	<5 % μ T (>95 % dip in μ T) for 0.5 cycle 40 % μ T (60 % dip in μ T) for 5 cycle 70 % μ T (30 % dip in μ T) for 25 cycles <5 % μ T (>95 % dip in μ T) for 5 s	Mains power quality should be that of a typical domestic commercial or hospital environment. If the user of the pump requires continued operation during mains power interruptions, it is recommended that the pump is powered from an uninterrupted power supply or battery.
Power frequency (50/60 Hz) Magnetic field IEC 61000-4-8	30 A/m	30 A/m	Power frequency magnetic fields should be at levels characteristic of a typical location in a typical domestic commercial or hospital environment.

Note: μ T is the a.c. mains voltage prior to application of the test level

At Arjo, we are committed to improving the everyday lives of people affected by reduced mobility and age-related health challenges. With products and solutions that ensure ergonomic patient handling, personal hygiene, disinfection, diagnostics, and the effective prevention of pressure ulcers and venous thromboembolism, we help professionals across care environments to continually raise the standard of safe and dignified care. Everything we do, we do with people in mind.