



MadaJet XL Product Manual

DENTAL, PODIATRY, MEDICAL, UROLOGY



MADA ULTRASONIC Cleaning System

Designed specifically for cleaning
the MadaJet XL prior to sterilization

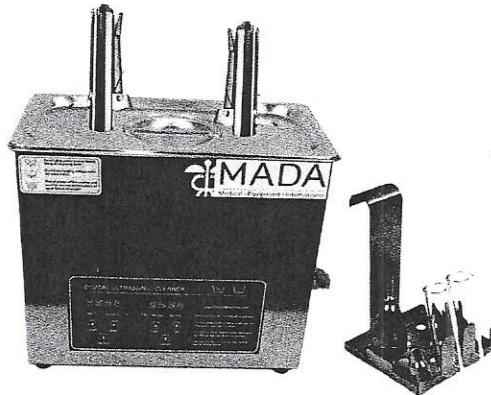

*Includes custom cover and rack
that holds up to 2 MadaJets.*

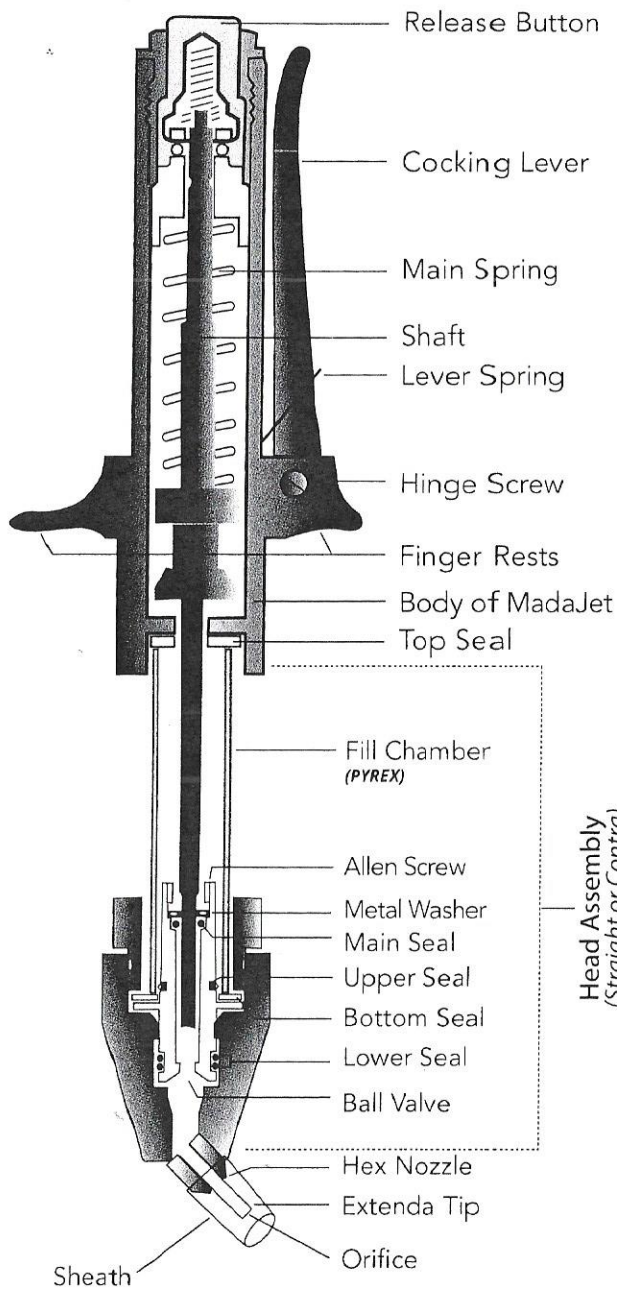

CAUTION: Please Use the Dental MadaJet XL only in the buccal cavity.

Do not inject digits to test MadaJet.

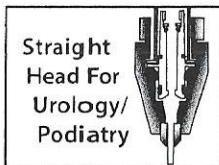

FILLING THE MADAJET XL

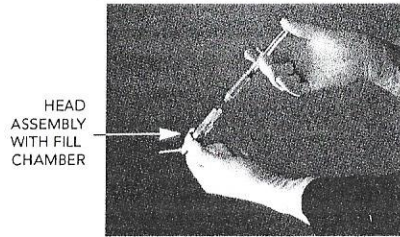

A

PRIMING ACTION

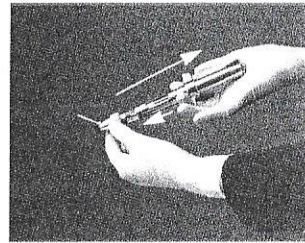

B

COCKING & FIRING

Hold the MadaJet XL nose face down in a vertical position. Grasp the body of the instrument with one hand, and with the other hand, pull the cocking lever down until it clicks into the firing position (90°). Repeat for each firing. *(See illustration C)*

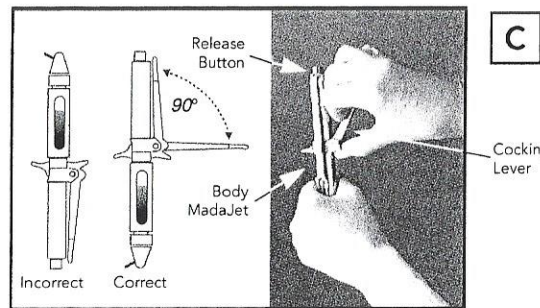

C

After cocking the instrument, the MadaJet XL can be fired by pressing the release button in any position. *(See illustration D)*

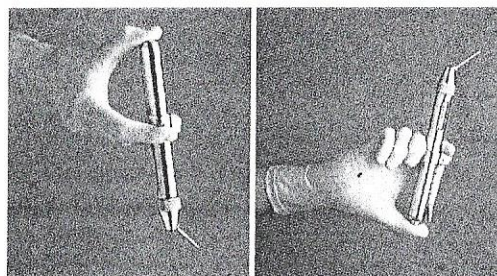

D

I. UPON RECEIVING YOUR MADAJET XL PACKAGE:

1. Please read all instructions before use. If you have any questions please contact Mada Medical for additional information.
2. The identity of all parts of the MadaJet XL are illustrated in this manual.
3. The MadaJet XL must be sterilized before use. Please read the following:

II. STERILIZATION METHODS

The following procedure should be used between each patient:

1. Remove the sheath, head assembly and fill chamber from the body of the MadaJet XL. Each component, along with the MadaJet XL body, is to be wrapped separately in sterilization pouches.
2. Pull the cocking lever down on the MadaJet XL body prior to placing it in its' sterilization pouch.

The MadaJet XL requires steam autoclaving by one of the following two methods:

Steam Pre-Vacuum Method

Temperature: 132°C (270°F)
Exposure Time: 4 minutes

Steam Gravity Method

Temperature: 132°C (270°F)
Exposure Time: 15 minutes

CAUTION: Do not use dry heat sterilization

III. ASSEMBLING THE MADAJET XL :

1. Unwrap sterile parts using sterile gloves.
2. Depress the MadaJet XL release button prior to re-assembly.
3. Insert Pyrex fill chamber onto head assembly and transfer 3cc of anesthetic via sterile syringe from a carpule or multi-dose vial into the fill chamber *(see illustration A)*.
4. Priming Action: Thread the head assembly back onto the body keeping the instrument in a vertical position with the head pointing down *(see illustration B)*.

IV. PROCEDURE TO INJECT:

1. Cock the MadaJet XL with the nose facing down *(see illustration C)*.
2. Place the end of the sheath gently at the site to be injected.
3. Press release button to discharge MadaJet XL. Repeat #1 above for each injection given.

CAUTION: Vasoconstrictors such as Epinephrine should not be used in tissue with reduced vasculature, i.e. hands, digits, or other areas with limited blood flow. The vasoconstrictors should be limited to intraoral use with the dental MadaJet XL.

V. AFTER EACH USE:

1. Unscrew head assembly and pour out any unused anesthetic solution.
2. Pour 3cc of MadaCide-FD into the head assembly, reassemble onto the MadaJet XL body, then cock and fire the MadaJet XL 2-3 times to clear out any remaining traces of anesthetic solution.
3. Unscrew the head assembly and pour out remaining MadaCide-FD.
4. Refill the fill chamber with sterile or distilled water, then cock and fire the MadaJet XL 2-3 times to clear out any remaining traces of MadaCide-FD solution.
5. Follow the sterilization methods detailed in this manual.

CARE OF THE MADAJET XL

Following the steps outlined will help to ensure that your MadaJet XL provides you with many years of reliable service.

In order to maintain consistent performance, we recommend that you return your MadaJet XL annually to Mada Medical for routine maintenance.

When the MadaJet is not in use, place it with the head assembly facing down in the stainless steel stand that has been filled halfway (approximately 30cc) with MadaCide-FD cleaner/disinfectant.

Never submerge the entire MadaJet body in any solution.

Distributed By

