

TRIDENT

TRIDENT 



**drive**<sup>TM</sup>

OWNER'S MANUAL

# TABLE OF CONTENTS



I.	PREFACE.....	3
II.	SAFETY NOTICES.....	4
III.	SAFETY GUIDELINES.....	6
IV.	EMI INFORMATION.....	13
V.	PARTS.....	14
VI.	ASSEMBLY.....	16
VII.	COMFORT ADJUSTMENTS.....	18
VIII.	OPERATION.....	22
IX.	BATTERIES & CHARGING.....	24
X.	INSPECTION & MAINTENANCE.....	26
XI.	BASIC TROUBLESHOOTING.....	30
XII.	SPECIFICATIONS.....	31
XIII.	LIMITED WARRANTY.....	32
XIV.	ACCESSORIES.....	34

# I. PREFACE

Please read this Owner's Manual before operating your power wheelchair for the first time. Improper use or unfamiliarity of the power wheelchair may result in harm, injury, or traffic accidents.

This Owner's Manual includes operation instructions, assembly instructions, and best practices to ensure maximum use from your power wheelchair.

The symbols used throughout this Owner's Manual are explained below. Read carefully, and fully understand the sections marked with these symbols:

	<b>WARNING</b> – Improper use could lead to death, serious injury, hazardous conditions, or product malfunction.
	<b>ATTENTION</b> – Improper use could lead to injury and/or damage to your power wheelchair.
	<b>SUGGESTION</b> – Follow these instructions for best practices, and to keep your power wheelchair in prime operating order.

This Owner's Manual includes a repair maintenance record chart and warranty. Please keep it in a safe place, or with the power wheelchair.

If someone else uses the power wheelchair, please provide a copy of the Owner's Manual for their consideration.

This Owner's Manual is composed from the product design and specifications at the time of publication. As designs change, some illustrations and pictures in the manual may not correspond to the power wheelchair that you purchased. We reserve the right to make design modifications.

This product has been designed to provide a comfortable and secure solution for individuals limited to a seated position who are capable of operating a power wheelchair.

The manufacturer disclaims all responsibilities for any personal injury or property damage which may occur as a result of improper or unsafe use of this product.

## II. SAFETY NOTICES

- \* Read and follow the information in the owner's manual.
- \* Fully charge the battery after every trip and prior to using the power wheelchair. If you do not frequently use the power wheelchair fully charge the batteries every two weeks to prevent battery failure.
- \* If the battery gauge drops to red, charge the power wheelchair as soon as possible. Completely discharging the batteries may damage the batteries, or shorten the expected life of the batteries.
- \* Batteries contain lead and lead compounds. Wear proper safety attire when handling batteries.
- \* Only use sealed lead acid AGM or gel-cell batteries in this product.
- \* Keep metal objects away from the battery terminals, electric shock may occur.
- \* Always replace both batteries at the same time for optimum performance.
- \* Always make sure the power is turned off when getting in and out of the power wheelchair.
- \* Always make sure freewheel levers are in the drive position before getting in or out of the power wheelchair.
- \* Do not put the power wheelchair in freewheel when on an incline or decline.
- \* To ensure the user's familiarity with the power wheelchair's operation, practice driving at low speeds in a spacious hazard-free area travelling forward, backward, left, right, decelerating, maneuvering up inclines, and down inclines.
- \* Avoid unnecessary movement of the power wheelchair.
- \* Always wear the seat belt included with this product when operating.
- \* Never reach, lean or bend when driving your power wheelchair.

## II. SAFETY NOTICES

- \* Avoid exposure to moisture, standing water, rain, snow, ice or salt when possible.
- \* Store in a clean and dry condition.
- \* Do not drive your power wheelchair at night without proper lighting.
- \* Do not remove the anti-tip wheels.
- \* Keep your feet on the footplate at all times during operation.
- \* Do not stand on the footplate.
- \* Keep your hands and feet away from moving parts while driving.
- \* Be aware of loose fitting clothes that can become caught in the drive wheels.
- \* Do not connect an extension cord to the battery charger.
- \* Disassembling the controller, motor, or charger by anyone other than an authorized Drive Medical service agent is prohibited, and voids any applicable warranty.
- \* Do not take your power wheelchair on roads or highways.
- \* Do not operate your power wheelchair when you are tired, or after consuming alcohol.
- \* Be cautious when driving your power wheelchair in busy areas or shopping malls.
- \* Under no circumstances should the power wheelchair be used as a seat in a motor vehicle.
- \* Do not attempt to lift your power wheelchair by any parts other than the frame.
- \* If you will be seated in your power wheelchair for an extended period of time, power off the power wheelchair. This will prevent inadvertent movement from unexpected joystick contact.

# III. SAFETY GUIDELINES

## GENERAL GUIDELINES

Before operating your power wheelchair fully read and understand this Owner's Manual.

Be sure to follow the setup instructions prior to using your power wheelchair for the first time.

Users may encounter difficult maneuvering situations such as narrow doorways, travelling up and down ramps, cornering, and travelling on uneven terrain. Be sure to lower the speed, take your time, and carefully maneuver the power wheelchair.

## MODIFICATIONS

Do not modify, remove, disable, or add any parts, features, or functions on your power wheelchair. Drive Medical offers a wide variety of accessories for your power wheelchair to help accommodate your needs.



**WARNING** – Do not modify your power wheelchair in any way; doing so will void the warranty.

## SAFETY CHECK



**ATTENTION** – Inspect the following components before each use:

- \* Electrical connections – secure and free from corrosion
- \* Joystick connections – secure and routed properly to the base of the power wheelchair
- \* Freewheel Levers – engaged in drive position
- \* Batteries – fully charged and free from corrosion

If you notice a problem please contact your authorized Drive Medical Provider for assistance.

# III. SAFETY GUIDELINES

## WEIGHT CAPACITY

This power wheelchair has a maximum weight capacity that should never be exceeded. Please refer to Section XII SPECIFICATIONS for this information. The maximum weight capacity includes the user and any accessories.



**WARNING** – Exceeding the maximum weight capacity will void your warranty. Drive Medical will not be held responsible for injuries and/or damages resulting from failure to observe weight capacities.



**WARNING** – Do not carry passengers on your power wheelchair. Your power wheelchair is designed and tested for one user to operate while seated with the safety belt fastened.

## INCLINE GUIDELINES

Use caution when approaching inclines or declines; if necessary lower the speed before travelling on a slope.

When travelling up an incline try to keep the power wheelchair moving forward. If you must come to a stop, use caution and slowly accelerate the power wheelchair forward.

When travelling down an incline lower the speed on your power wheelchair to the slowest setting, and proceed cautiously. If the power wheelchair is travelling down the incline faster than you expected, release the joystick to come to a stop, then slightly push the joystick forward to continue safely down the incline.



**WARNING** – Never put the power wheelchair in freewheel model while on an incline.



**WARNING** – Drive your power wheelchair straight up or down an incline, never backwards. Erratic movements, or back and forth patterns may increase the chance of tipping.

## III. SAFETY GUIDELINES



**WARNING** – Do not travel up an incline with the seat completely reclined without an attendant. Inclines vary, and doing so may decrease stability.



**WARNING** – Do not, under any circumstances, travel on a slope greater than the maximum climbing angle for this power wheelchair. Please refer to Section XII SPECIFICATIONS for this information. Exceeding the climbing angle may cause unstable conditions.

### FREEWHEEL GUIDELINES

Your power wheelchair is equipped with manual freewheel levers to maneuver the unit without power. The manual freewheel levers can be engaged or disengaged.

Disengaged, or “freewheel” mode, releases the locking mechanism on the gearbox allowing the power wheelchair to roll freely with or without power.

Engaged, or “drive” mode, secures the locking mechanism on the gearbox preventing the power wheelchair from rolling freely.



**WARNING** – Never attempt to personally put your power wheelchair in freewheel mode while seated in the unit.



**WARNING** – Never put the power wheelchair in freewheel mode while on an incline. This may cause uncontrollable movements.



**ATTENTION** – When your power wheelchair is in freewheel mode you may feel resistance when maneuvering; this is normal, and prevents damage to the gearbox.



**ATTENTION** – Please refer to Section V PARTS to locate the freewheel levers on your power wheelchair.



**SUGGESTION** – If you hear a “clicking” noise when moving the joystick, but the power wheelchair will not move – turn off the power, engage the freewheel levers, and power back on to continue.



# III. SAFETY GUIDELINES

## BRAKES & STOPPING

Coming to a stop in your power wheelchair can simply be done by releasing the joystick. The joystick will automatically return to the center position, and the power wheelchair will come to a stop.



**ATTENTION** – Quickly moving the joystick in the opposite direction of travel will cause the power wheelchair to come to an abrupt stop, and if held continuously in the opposite direction may cause erratic movements if you are unfamiliar with the controls.

Your power wheelchair is equipped with two types of brake systems:

- \* Regenerative brakes – when the joystick is returned to the center position, or stop neutral position, regenerative brakes use electricity to quickly decelerate the vehicle.
- \* Park brakes – once the power wheelchair comes to a complete stop the park brake activates automatically locking the drive wheels.

## OUTDOOR OPERATION & INCLEMENT WEATHER PRECAUTIONS

While your power wheelchair is purposed for in-home use to assist you in daily living activities; Drive Medical understands there are times you need to operate the power wheelchair outdoors, and has designed it to perform superbly on level outdoor surfaces.



**ATTENTION** – When operating outdoors avoid uneven terrain, soft surfaces, tall grass, loose gravel, loose sand, fresh water, salt water, edges of streams, lakes or oceans. If you are unsure about a surface, avoid it.

Exposure to inclement weather should always be avoided. If you find yourself caught in inclement weather while operating your power wheelchair, proceed to the closest shelter immediately. Completely dry your power wheelchair before operating, charging, or storing.

# III. SAFETY GUIDELINES

## STEPS, CURBS & FIXED OBSTACLES

Use extreme caution when operating your power wheelchair near curbs, porches, stairs, escalators, drop-offs, unprotected ledges, and raised areas.



**WARNING** – Never attempt to navigate your power wheelchair over a fixed obstacle taller than the maximum ground clearance. Please refer to Section XII SPECIFICATIONS for this information.



**WARNING** – Never attempt to navigate your power wheelchair backwards over an obstacle.



**WARNING** – Never attempt to operate your power wheelchair on steps or escalators.



**ATTENTION** – Refer to the following guidelines and diagrams when travelling over a fixed obstacle lower than the maximum ground clearance of your power wheelchair:

To maneuver up a fixed obstacle – Approach slowly, and make sure the front of the power wheelchair is perpendicular to the obstacle. Increase the forward speed until the power wheelchair has cleared the obstacle, and then you may reduce the speed or return the joystick to neutral.

To maneuver down a fixed obstacle – Approach slowly, and make sure the front of the power wheelchair is perpendicular to the obstacle. Reduce the forward speed just before the front wheels come in contact with the obstacle, and remain at the reduced speed until power wheelchair has cleared the obstacle, and then you may increase the forward speed.

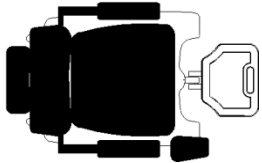
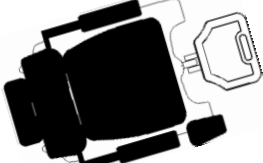
<p><b>CORRECT APPROACH:</b></p>  <p>C U R B</p>	<p><b>INCORRECT APPROACH:</b></p>  <p>C U R B</p>
--	--

# III. SAFETY GUIDELINES

## TRANSPORTING YOUR POWER WHEELCHAIR

When transporting your power wheelchair by vehicle it should be securely stowed in the back of a van, truck, or trunk of a car. Adjustable parts should be removed or properly secured during transport.



**WARNING** – Do not sit in your power wheelchair while in a moving vehicle.

## SAFETY BELT

A safety belt is included with your power wheelchair. Your authorized Drive Medical Provider, assistive technology therapist, or healthcare professional are responsible for determining your requirement for a safety belt to operate your power wheelchair safely. Once determined, securely fasten the safety belt.



**WARNING** – The safety belt is not designed for use as a seat belt in a motor vehicle, or any other transportation device.

## TRANSFERS

Always have an attendant present while transferring in and out of your power wheelchair.



**ATTENTION** – To reduce the possibility of an injury; perform transfers after the following steps are followed:

Safely reduce the distance between your power wheelchair and the object you are transferring onto, ensure your power wheelchair is not in freewheel mode, turn the power off, flip up or remove the armrests, and flip up the foot platform or swing aside the leg rests.



**WARNING** – Position yourself as far back possible before transferring, and never place your weight or downward force on the joystick.

# III. SAFETY GUIDELINES

## PHYSICAL LIMITATIONS, Rx DRUGS, ALCOHOL & SMOKING

You must exercise awareness, caution, care, and common sense when operating your power wheelchair. Always keep in mind your own limitations, and substance use when operating your power wheelchair.



**WARNING** – Never use your power wheelchair while under the influence of alcohol or mind altering substances.



**WARNING** – Never smoke while seated in your power wheelchair. Damaged or worn upholstery increases the risk of fire hazard, and should be replaced immediately.



**ATTENTION** – Be aware of your own physical limitations when familiarizing yourself with the power wheelchair.



**ATTENTION** – Be aware of precautions, warnings, and safety issues when taking prescribed or over-the-counter drugs while operating your power wheelchair.

## IV. EMI INFORMATION

Electromagnetic interference (EMI) tests have shown to produce adverse effects on the performance and control of electrically powered mobility devices.

EMI can be produced from different sources such as cellular phones, two-way radios, radio stations, television stations, amateur radio transmitters (HAM), wireless computer links, microwave signals, paging transmitters, and transceivers used by emergency vehicles.

The EMI waves can cause unintentional movement of the power wheelchair, or damage to the controller. Every electrical powered mobility device has a resistance to EMI. The higher the resistance level the greater the protection. The intensity of the interference can be measured in volts per meter, V/m.

At this time, current technology is capable of achieving an immunity level of 20 V/m, which provides protection from more common sources of EMI. Your power wheelchair, with no modifications, has an immunity level of 20 V/m.

EMI becomes more intense as you move closer to the source. The EMI produced from hand-held radios are of special concern. It is possible to unintentionally bring high levels of EMI very close to the power wheelchair's control system, effecting your movement and braking. The warnings listed below are recommended to prevent possible interference with the control system of your power wheelchair.



**WARNING** – Do not operate hand-held transceivers such as CB (citizens band) radios, or turn on personal communication devices, such as cellular phones, while the power wheelchair is powered on.



**WARNING** – Be aware of nearby transmitters, such as radio or television stations, and avoid close proximity.



**WARNING** – If you experience unintended movement or brake release occurs, power off as soon as it is safe. Please report EMI incidents to Drive Medical.

# V. PARTS

Please refer to the diagram below to identify your power wheelchair parts. Familiarize yourself with the terminology to better understand part references throughout the Owner's Manual.

1. Headrest
2. Seat Back
3. Armrests
4. Controller
5. Controller Harness
6. Adjustment Knobs
7. Seat Base
8. Seat Bracket
9. Freewheel Levers
10. Caster Forks
11. Caster Wheels
12. Drive Wheels
13. Foot Platform
14. Anti-Tip Wheels



# V. PARTS

Please refer to the diagram below to identify your power wheelchair electrical components. Familiarize yourself with the terminology to better understand references throughout the Owner's Manual.

1. Controller
2. Keypad Overlay
3. Charger Input
4. Controller Harness
5. Power Module
6. Left Motor
7. Left Motor Harness
8. Right Motor
9. Right Motor Harness
10. Battery 1
11. Battery 2
12. Circuit Breaker
13. In-Line Fuses
14. Battery Harnesses

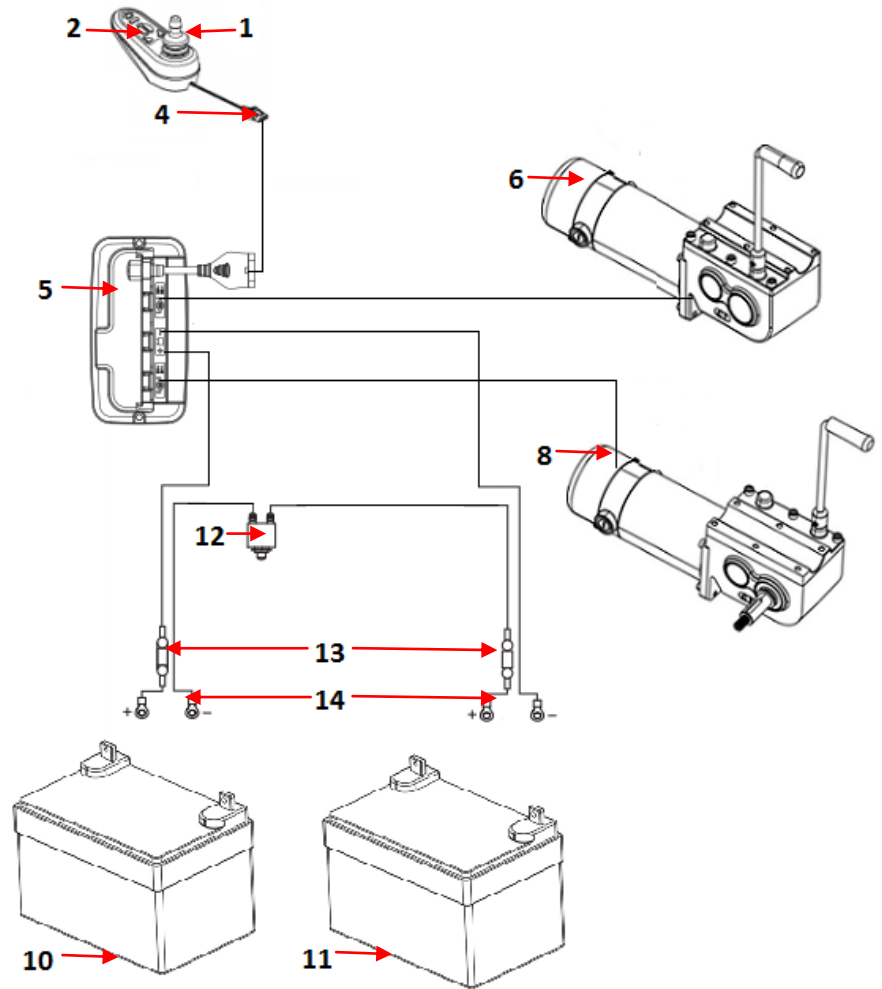

Alternate View

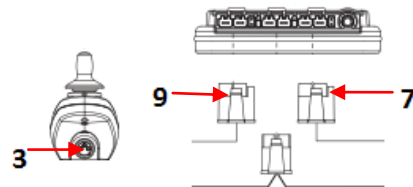



# VI. ASSEMBLY

Your power wheelchair requires assembly prior to initial use. Please be sure to follow these steps to properly set up your power wheelchair.

**Step 1:**  
Attach the armrests to the power wheelchair base by inserting the armrests into the attachment points on the seat frame.



**Step 2:**  
Secure the armrests by tightening the star knobs on the back of the seat frame.



**Step 3:**  
Make sure the power wheelchair's battery harnesses are connected. Then route the joystick harness under the seat frame to connect to the power module.





## VI. ASSEMBLY

### Step 4:

Attach the seat onto the base of the power wheelchair by aligning the rear “U” shaped hooks with the pins on the seat frame.



### Step 5:

With the seat on the base of the power wheelchair, insert the quick-release pin through the bracket on the bottom of the seat through the seat frame, and lock into place.



### Step 6:

Fully charge the power wheelchair by inserting the round charger connector into the battery charging terminal on the front of the controller, and then insert the 3-pronged plug into a standard electrical outlet.



# VII. COMFORT ADJUSTMENTS

Prior to using your power wheelchair, you may want to make adjustments for optimum comfort. Make all adjustments with the power wheelchair off, and unoccupied. You may need the tool-kit included with your power wheelchair to make these adjustments.



**WARNING** – Some components of your power wheelchair are heavy, and you may need assistance to lift or carry. Please refer to Section XII SPECIFICATIONS for component weights.



**WARNING** – Do not make any adjustments while an occupant is seated in the power wheelchair.

## Seat Height Adjustment:

Remove the seat from the base, and locate three quick-release pins securing the seat frame to the power wheelchair base. Remove the quick-release pins, and adjust the seat frame to the desired height. Reinstall the quick-release pins securely to reduce vibrations.



# VII. COMFORT ADJUSTMENTS

## Armrest Height:

The armrest height can be adjusted by loosening the star knob on the top side of the armrest, and sliding the armrests up or down to the desired height.



## Armrest Width:

The armrest width can be adjusted by loosening the star knob on the seat frame, and sliding the armrests inward or outward to the desired width.



# VII. COMFORT ADJUSTMENTS

## Footplate Height:

The footplate height can be adjusted by loosening the nut and bolt attaching the footplate to the height adjustment point on the frame of the power wheelchair. Reposition the footplate to the desired height, and securely fasten the nut and bolt back in place.



## Footplate Depth:

The footplate depth can be adjusted by loosening the star knob attaching the footplate to the frame of the power wheelchair. Reposition the footplate to the desired depth, and securely fasten the star knob back in place.



## Footplate Angle:

The footplate angle can be adjusted by lifting up on the footplate, and tightening or loosening the bolt under the footplate. Tightening will lower the angle, and loosening will raise the angle of the footplate.

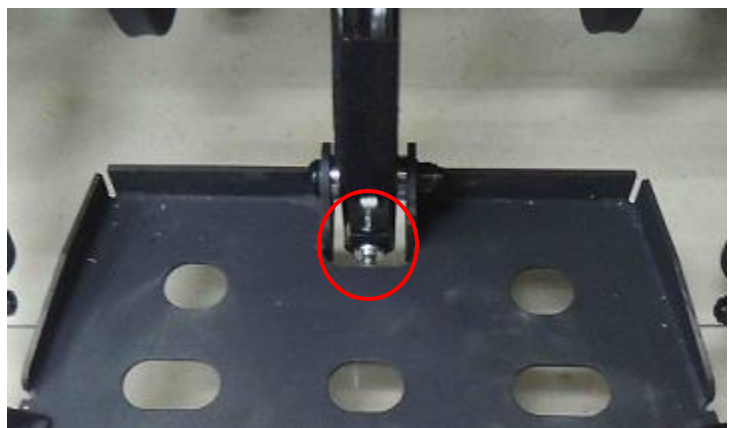

## VII. COMFORT ADJUSTMENTS

### Joystick Position:

The position of the joystick can be adjusted by loosening the star knob on the underside of the controller arm and sliding the arm forward or backward to the desired position.



### Seat Recline:

The reclining angle of the seat can be adjusted by pulling up on the lever on the side of the seat.





## VIII. OPERATION

After your power wheelchair is assembled, and adjustments have been made you are now ready to operate your power wheelchair. Refer to the controller diagram on the following page for key functions.

The power button applies power to the control system electronics, which in turn supplies power to the motors. Press the power button to turn on your power wheelchair.



**ATTENTION** – Do not use the power button to stop, or as a brake. Doing so may shorten the life of the drive components.



**SUGGESTION** – It is recommended you start at the slowest speed setting when familiarizing yourself with your power wheelchair controls. Once you feel comfortable with the controls, and movement of the power wheelchair you may then increase the speed.

Press the speed down button to the lowest speed setting. Start to steer, moving the joystick to drive forward, backward, left or right. If you want to stop the power wheelchair, release the joystick and it will automatically return to the center position to stop the unit. Once familiar with the controls press the speed up button to increase the top speed to a comfortable setting.

When the power wheelchair is turned on, the battery gauge will light up from left to right with red, orange, and green lights indicating:

**Red lights only:** Your power wheelchair should be charged as soon as possible.

**Red and orange lights only:** Do not drive your power wheelchair for a long trip.

**Red, orange, and green lights:** Your power wheelchair has full battery capacity.

# VIII. OPERATION

## Controller Functions:

1. Battery Gauge

2. Power On/Off

3. Horn

4. Speed Gauge

5. Speed Down

6. Speed Up

7. Joystick

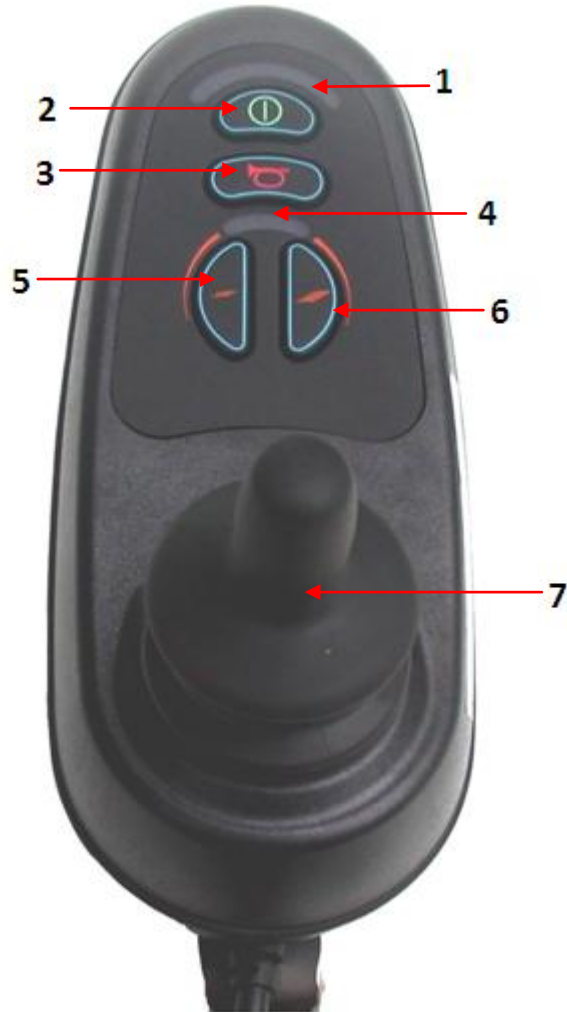

# IX. BATTERIES & CHARGING

## CHARGING YOUR POWER WHEELCHAIR

To charge your power wheelchair, position the front of the unit next to a standard electrical outlet. Be certain the freewheel levers are engaged, and the power is turned off. Plug the charger into the electrical outlet, and then into the power wheelchair. When the batteries are fully charged remove the charger from the power wheelchair, and then from the electrical outlet.



**SUGGESTION** – The lights on your charger indicate different charge statuses. The light indicators can be found on the charger itself, or the manual provided with the charger. In most cases your charger will show a red or orange light when charging, and a green light when fully charged.

## BATTERY BREAK-IN

To ensure maximum use from your new batteries fully charge the power wheelchair prior to initial use for 8 to 12 hours. Operate your power wheelchair until the battery gauge shows only red and orange lights, and then give your power wheelchair another full charge for 8 to 12 hours.

## BATTERY MAINTENANCE & CHARGING HABITS

To ensure maximum life from your batteries, and continued use of your power wheelchair please follow these charging guidelines based on your usage:



**SUGGESTION** – If you use your power wheelchair on a daily basis, charge the batteries as soon as you are finished with the day's activities, and leave it on the charge until you are ready to use the following day.



**SUGGESTION** – If you use your power wheelchair infrequently, charge the batteries once a week for 10 to 14 hours.



# IX. BATTERIES & CHARGING

## BATTERY RANGE

There are many factors that affect the range of your batteries, including the surfaces, inclines, curves, or wind you encounter when operating your power wheelchair. If not ideal conditions, all of these factors will reduce the travel time or distance between charges. Follow these suggestions for maximum range:



**SUGGESTION** – Fully charge the batteries prior to any trip, and plan your trip in advance to avoid inclines.



**SUGGESTION** – Limit baggage and accessory weight to essential items, and maintain an even speed avoiding stop-and-go driving.

## PUBLIC TRANSPORTATION

Sealed lead acid AGM or gel-cell batteries are designed for use in power wheelchairs. These batteries are Federal Aviation Administration (FAA) approved. Since there is no danger of spillage or leakage, this allows for safe transportation on aircraft, buses, and trains.



**SUGGESTION** – When transporting your power wheelchair on public transportation contact your carrier's ticket counter in advance to determine their specific requirements.

# X. INSPECTION & MAINTENANCE

## GENERAL GUIDELINES

Your power wheelchair is an advanced mobility device, and with the correct routine maintenance you can ensure years of maximum use. While some of the maintenance can be done by yourself, you may need assistance from an authorized Drive Medical provider. If you have any doubts, contact your authorized Drive Medical provider.

Preventative maintenance is key to keeping your power wheelchair in prime operating condition. Follow the Maintenance Schedule at the end of this section to periodically inspect your power wheelchair for serviceable items.

- \* Avoid abuse to the controller and joystick.
- \* Avoid prolonged exposure to extreme heat or cold.
- \* Keep the controller clean and free from moisture.
- \* Never use a conditioner on the tread of the wheels.

## EXPOSURE TO MOISTURE

Should your power wheelchair come in contact with water or moisture, dry your power wheelchair thoroughly with a towel. Allow your power wheelchair to sit in a dry place for 8 to 12 hours to allow unseen moisture to evaporate. Check the joystick operation and brakes before using your power wheelchair again. If any items require service please contact your authorized Drive Medical provider.

## OPERATING TEMPERATURES

Your power wheelchair is designed to operate ideally between 18°F and 122°F. In extremely cold conditions your batteries may freeze depending on the battery charge, usage, and composition of the batteries. In extremely hot conditions your power wheelchair may operate at a lower speed. This is due to the safety mechanism built into the unit to prevent damage to the gearbox and other electronic functions when operating too hot.

# X. INSPECTION & MAINTENANCE

## STORAGE

If you need to store your power wheelchair, be sure it is stored in a dry place free from extreme temperatures. Always fully charge, and then disconnect the batteries prior to storage.



**ATTENTION** – Infrequently charged batteries, or batteries stored without a full charge are susceptible to permanent damage, causing unreliable performance from your power wheelchair.

If your power wheelchair is stored for a prolonged period flat spots may develop in the wheels. This will cause an uneven sensation when driving, but should work itself out over time. If you still notice the flat spots after continued use, replace the wheels on your power wheelchair immediately.



**SUGGESTION** – You can place a sturdy platform under the frame of your power wheelchair to bring the wheels off the ground, and weight off the wheels. This will prevent flat spots from developing while storing your power wheelchair.



**WARNING** – Improper storage of your power wheelchair may result in permanent damage to the frame and electronics.

## CLEANING & DISINFECTION

To clean your power wheelchair use a damp cloth with a mild, non-abrasive cleaner on the plastic and metal parts. If necessary, clean your power wheelchair with an approved disinfectant safe for use on your unit.



**WARNING** – Never hose off your power wheelchair or expose it to direct contact with water.



**WARNING** – Never use any chemicals on the upholstery of your seat, this may cause the seat to dry out and crack.

# X. INSPECTION & MAINTENANCE

## DISPOSAL OF YOUR POWER WHEELCHAIR & PARTS

You must follow applicable local and national regulations when disposing of your power wheelchair, or defective power wheelchair parts. Contact your local waste agency, recycling center, or authorized Drive Medical provider for information on proper disposal.

## CONTACTING YOUR AUTHORIZED DRIVE MEDICAL PROVIDER

The following conditions may indicate a serious problem with your power wheelchair. Contact your authorized Drive Medical provider if one of the following conditions occurs:

- \* Motor or gearbox noise
- \* Frayed electrical harnesses
- \* Cracked or broken connections
- \* Uneven wear on the tires
- \* Veering to one side
- \* Bent or broken wheel assemblies
- \* Will not power on
- \* Loose seat or seat components



**SUGGESTION** – Fill out your authorized Drive Medical provider’s information below, along with your power wheelchair information for quick reference in the event you may need service.

**AUTHORIZED DRIVE MEDICAL PROVIDER:** \_\_\_\_\_

**ADDRESS:** \_\_\_\_\_

**PHONE NUMBER:** \_\_\_\_\_

**DATE OF PURCHASE:** \_\_\_\_\_

**MODEL:** \_\_\_\_\_

**SERIAL NUMBER:** \_\_\_\_\_

# X. INSPECTION & MAINTENANCE

## MAINTENANCE SCHEDULE

Inspect your power wheelchair routinely for service issue or wearable items.

INSPECTION	DAILY	WEEKLY	MONTHLY
Inspect the joystick is not bent when in neutral or rest position	<input checked="" type="checkbox"/>		
Inspect the controller harness is not frayed or has exposed wires	<input checked="" type="checkbox"/>		
Check for flat spots on tires	<input checked="" type="checkbox"/>		
Inspect seat, armrests, and front riggings for loose hardware or damage	<input checked="" type="checkbox"/>		
Inspect controller harness is free from corrosion		<input checked="" type="checkbox"/>	
Inspect all harnesses to the controller are securely fastened		<input checked="" type="checkbox"/>	
Check the brakes for functionality at lowest speed setting		<input checked="" type="checkbox"/>	
Check the anti-tip wheels for wear, and contact with the ground while at rest			<input checked="" type="checkbox"/>
Check for sufficient tread on the drive tires			<input checked="" type="checkbox"/>
Check the caster wheels for wear and sufficient tread			<input checked="" type="checkbox"/>
Check the caster forks for fluttering or damage			<input checked="" type="checkbox"/>
Check the entire power wheelchair for loose hardware or changes in performance			<input checked="" type="checkbox"/>
Check the entire power wheelchair and clean any mud, dirt, hair, food, drink, etc. on the unit			<input checked="" type="checkbox"/>

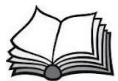

**SUGGESTION** – Once a year take your power wheelchair to an authorized Drive Medical provider for inspection and maintenance.

# XI. BASIC TROUBLESHOOTING

The diagnostic flash codes for your power wheelchair are designed to help you perform basic troubleshooting quickly and easily. A diagnostic flash code can be displayed in one of two ways:

- \* A small wrench will flash under the horn button a certain number of times indicating the diagnostic code

OR

- \* The number of battery gauge lights flashing indicates the diagnostic code

Please refer to the diagram below for flash codes, description of problem, and recommended actions.

Flash Code	Description	Recommended Action
1	Battery Fault	Charge batteries. Check battery cables and connections.
2	Left Motor Fault	Check motor connections and leads between left motor and power module
3	Left Motor Wiring	Check all connections and leads between left motor and the battery.
4	Right Motor Fault	Check motor connections and leads between right motor and power module.
5	Right Motor Wiring	Check all connections and leads between left motor and the battery.
6	Charger Inhibit	Disconnect the battery charger from the controller.
7	Joystick Fault	Make sure the joystick is in the center position before powering on the power wheelchair.
8	Power Module Fault	Check all electrical connections and leads for a secure connection.
9	Park Brake Fault	Put the freewheel levers in "drive" mode. Check parking brake connections.
10	Battery Fault	Excessive battery voltage, check all connections.

Once the recommended action is taken, turn the power wheelchair off and then back on again to clear the flash code. If the problem was not corrected, or another problem exists the controller may display another flash code.

## XII. SPECIFICATIONS

<b>WEIGHT CAPACITY</b>	<b>300 lbs.</b>
<b>TOP SPEED*</b>	<b>4.5 mph</b>
<b>ESTIMATED RANGE*</b>	<b>15 miles</b>
<b>MAX. CLIMBING ANGLE</b>	<b>7.5°</b>
<b>TURNING RADIUS</b>	<b>23.5"</b>
<b>GROUND CLEARANCE</b>	<b>2"</b>
<b>OVERALL DIMENSIONS</b>	
<b>LENGTH</b>	<b>40.5"</b>
<b>WIDTH</b>	<b>25.5"</b>
<b>HEIGHT</b>	<b>44"</b>
<b>SEAT DIMENSIONS</b>	
<b>WIDTH</b>	<b>18 – 20"</b>
<b>DEPTH</b>	<b>18.5"</b>
<b>BACK HEIGHT</b>	<b>20.5"</b>
<b>POWER</b>	
<b>MOTOR</b>	<b>320W x 4600RPM</b>
<b>CONTROLLER</b>	<b>PG VR2 50A</b>
<b>BATTERIES</b>	<b>12V x 35AH</b>
<b>BATTERY CHARGER</b>	<b>3A</b>
<b>BRAKES</b>	<b>Gear-Locking Lever</b>
<b>FREEWHEEL MODE</b>	<b>YES</b>
<b>TIRES</b>	<b>Flat-Free</b>
<b>CASTER WHEELS</b>	<b>8" x 2"</b>
<b>DRIVE WHEELS</b>	<b>14" x 3"</b>
<b>WEIGHTS</b>	
<b>BASE WEIGHT</b>	<b>95 lbs.</b>
<b>BATTERY WEIGHT (PAIR)</b>	<b>53 lbs.</b>
<b>SEAT WEIGHT</b>	<b>45 lbs.</b>
<b>TOTAL WEIGHT</b>	<b>193 lbs.</b>

\* Speed and range vary with user weight, type of terrain, battery charge and condition

The information contained herein is correct at the time of publication; Drive Medical reserves the right to alter specifications without prior notice.

# XIII. LIMITED WARRANTY

For the warranty periods listed below, beginning at the date of original purchase, Drive Medical will repair or replace, at its option to the original purchaser, free of charge, any of the following parts found upon examination by an authorized representative of Drive Medical to be defective in materials and/or workmanship. The warranties contained herein extend and apply only to the original purchaser.

- |                  |   |  |                                  |  |
|------------------|---|--|----------------------------------|--|
| Limited Lifetime | ○ Main Frame                                      | ○ Seat Post                            | ○ Platform                       | ○ Frame Welds                                |
| 14 Months        | ○ Electrical harness<br>○ Controller<br>○ Charger | ○ Joystick<br>○ PC Board<br>○ Throttle | ○ Motor /<br>gearbox<br>assembly | ○ Brakes<br>electromagnetic<br>function ONLY |

- 6 Months ○ Batteries are covered by a separate 6 month warranty provided by the battery manufacturer

The following items are warranted to be free of defects in workmanship and material at the time of delivery. If the following items are found to be defective or damaged immediately after the product is removed from the box, Drive Medical will repair or replace, at its option to the original purchaser, free of charge, the following items:

- |   |                         |                                   |                                      |
|---|-------------------------|-----------------------------------|--------------------------------------|
| ○ Plastic shrouds   | ○ Tires                 | ○ Tubes                           | ○ Anti-tip wheels                    |
| ○ Plastic footrests   | ○ Floor mats            | ○ Swing arm                       | ○ Motor brushes                      |
| ○ Upholstery and Seating                                    | ○ Armrest pads          | ○ Fuses and Bulbs                 | ○ Plastic connections                |
| ○ Metal connection pins, hardware, nuts, bolts & star knobs | ○ Bearings and bushings | ○ Front rigging mounting brackets | ○ Plastic components, excluding body |

## ADDITIONAL COMPONENTS

Items not mentioned or listed are covered at the discretion of Drive Medical. Any accessories, standard or optional, supplied by Drive Medical, are covered for a period of one year from the date of purchase with the particular unit.



# XIII. LIMITED WARRANTY

## RECONDITIONED UNITS WARRANTY

All reconditioned units are covered by a 90-day warranty from Drive Medical effective from the date of purchase.

## REPLACEMENT PARTS WARRANTY

Parts that are supplied by Drive Medical as replacements to warranted parts will be warranted for a period of time equal to the remainder of the original part's warranty period.

## SERVICE CHECKS AND WARRANTY SERVICE

Warranty service must be performed by an authorized Drive Medical provider. Do not return faulty parts to Drive Medical without prior written authorization. All transportation costs and shipping damage incurred while submitting parts for repair or replacement are the responsibility of Drive Medical.

Failure to follow the instructions, warnings and notes in the owner's manual and those located on your Drive Medical product can result in personal injury or product damage and will void Drive Medical's product warranty.

There is no other express warranty.

## IMPLIED WARRANTIES

Implied warranties, including those of merchantability and fitness for a particular purpose, are limited to one (1) year from the date of original purchase and to the extent permitted by law. Any and all other

implied warranties are excluded. This is the exclusive remedy. Liabilities for incidental, punitive, special and consequential damages under any and all warranties are excluded.

Some states do not allow limitations on how long an implied warranty lasts or do not allow the exclusion or limitation of incidental, punitive, special and consequential damages. The above limitation or exclusion may not apply to you.

This warranty gives you specific rights and you may also have other rights which vary from state to state.

## WARRANTY EXCLUSIONS

- Plastic shrouds and footrests
- Upholstery and seating
- Tires and tubes
- Brake pads
- Fuses
- Motor brushes
- Circumstances beyond the control of Drive Medical
- Labor, service calls, shipping and other charges incurred for repair of the product, unless specifically authorized by Drive Medical.
- Repairs and/or modifications made to any part without specific consent from Drive Medical.

# XIV. ACCESSORIES

Add functionality and convenience to your Drive power wheelchair with these options and accessories. Contact your authorized Drive Medical provider or visit [www.drivemedical.com](http://www.drivemedical.com) for more information.

**Swing-away  
Controller Arm**



- Allows joystick/controller to be moved to the side for easier transfers and approaching tables and desks
- Installs easily into controller mount

**Elevating Leg Rests  
(ELRs)**



- Allow the user to travel comfortably with their legs raised
- Some models require additional mounting hardware (sold separately)

**Cylinder Tank  
Carrier**



- For use with "D" size oxygen cylinders
- Constructed of durable steel
- Keeps tank secure with helpful hook-and-loop fasteners

**Crutch/Cane  
Holder**



- Sturdy steel construction
- Includes hook-and-loop-fasteners to keep your walking aid safely in place

**Drink Holder**



- Take your favorite hot or cold beverage with you anywhere
- Easily attaches to your product's armrest

**Backpack**



- Great seat-back storage for your items
- Super-sized, expandable main compartment with hook and loop fasteners
- 2 zippered compartments and 2 mesh side pockets

**Armrest Bag**



- Includes four pockets and mesh drink holder
- Top of the bag is padded so resting your arm on it is even more comfortable

**Seat Cover**



- Protects your product's Captain's Seat
- Includes separate fitted sections for headrest, seat back and seat cushion
- Available for 18", 20" & 22" Captain's Seats