

# Assembly Instructions

# step2bed™ XL

**Tools needed:**

- Phillips head screwdriver
- 13mm wrench.



"Remove all plastic wrap, corner step protectors and foam wrapping before assembly."

(1) Long Rail [A]



(1) Short Rail [B]

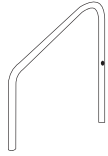

(1) Crossbar [C]

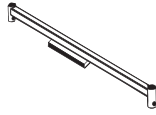

(1) Step [D]

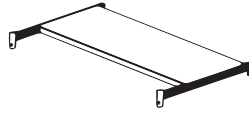

(4) Legs [E]



(6) Bolts and Nuts [F]

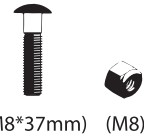

(1) LED Light [G]



1.

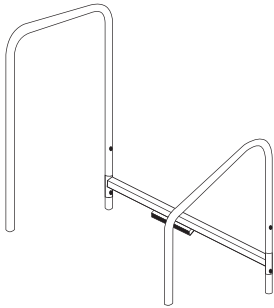

Insert A & B into holes of part C  
(Part A towards head of bed)  
(Part C with light bracket underneath cross bar)

2.

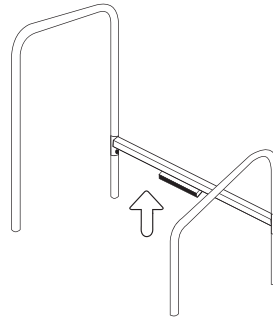

Raise part C to align with holes.

3.

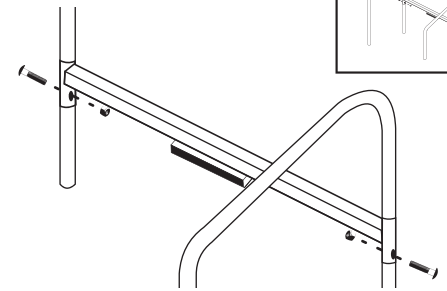

Insert two bolts (F) then apply & tighten nuts.

4.

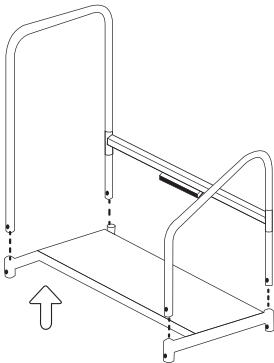

Insert A & B into holes of part D  
and raise to align with bolt holes.

5.

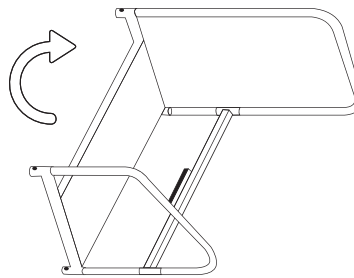

Turn step2bed XL on side.

6.

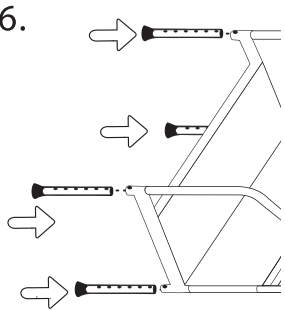

Insert all four legs (E) to desired height.

7.

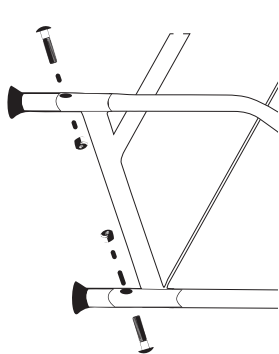

Insert four bolts (F) then apply & tighten nuts.

8.

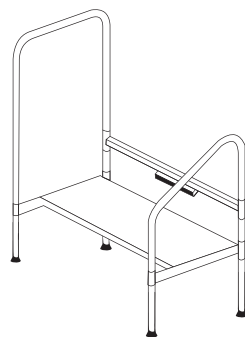

Stand step2bed XL upright.

9.

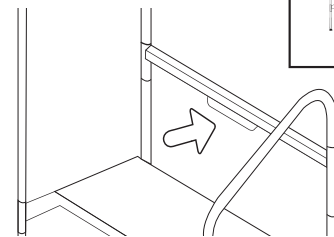

Peel two-sided tape off back of light (G) and attach to light bracket on part C with light & sensor facing out. See other side for details.

# Light Fixture



- LED light ONLY works when environment is dark  
 - LED light ONLY works when motion sensor is activated by movement

(1) LED Light [H] (1) Double-sided tape [I]



**Features:**

1. Can be taped and applied without screws.
2. Light will turn on automatically when passing by and turn off after leaving.
3. If the light sensor detects enough lights, then it will not turn on even if there is movement of human body.

**Specifications:**

1. Work voltage: DC3-6V
2. Static features: 50uA
3. Induction distance: 3-5m
4. Induction angle: <110
5. Delay time: 15s
6. Power by: 4 \*AAA battery
7. Warm light

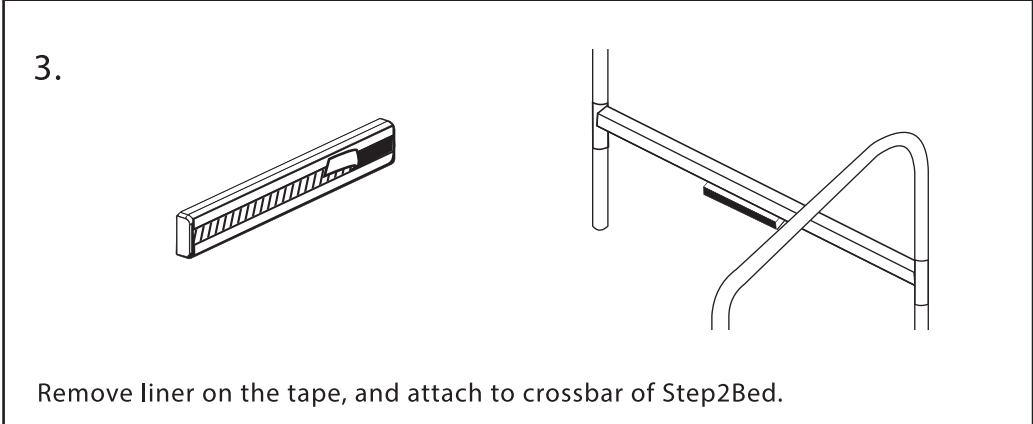
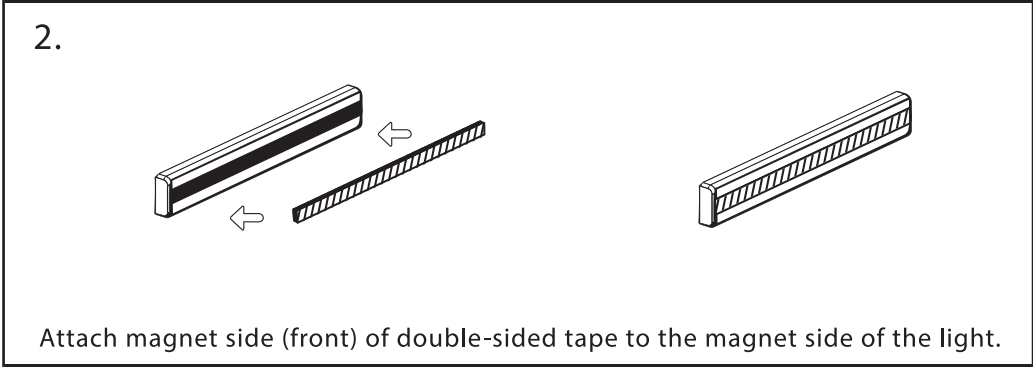
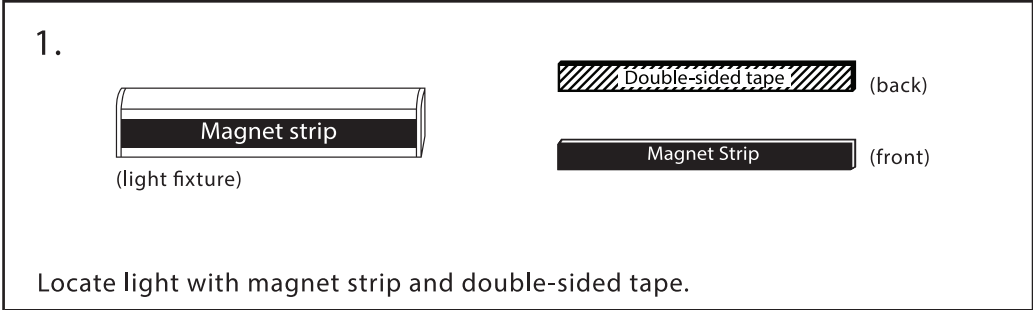
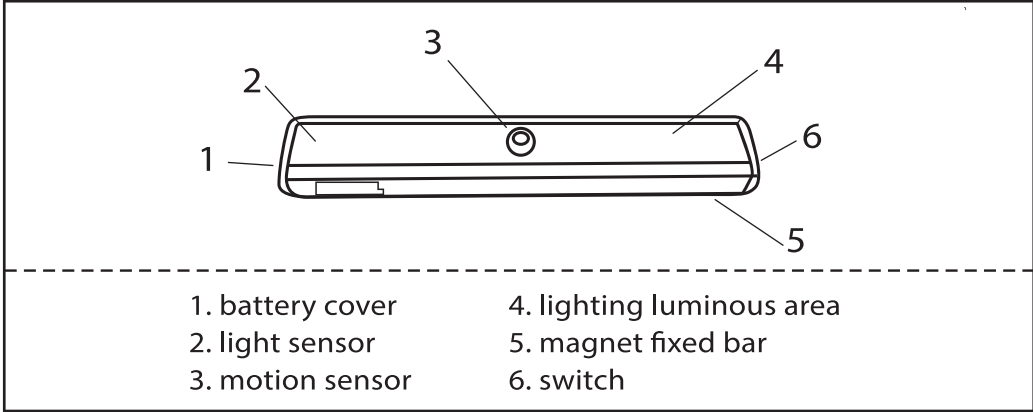

# Instructions For Attaching Velcro



Thank you again for purchasing the step2bed XL! We hope it helps you and your loved ones like it has so many other families.

As a courtesy, we have also included velcro in this unit in order to make the step2bed even more stable.

(1) Velcro



## SAFETY FIRST!

Please note that the velcro should not impede the use of the step2bed XL or cause any tripping hazard.

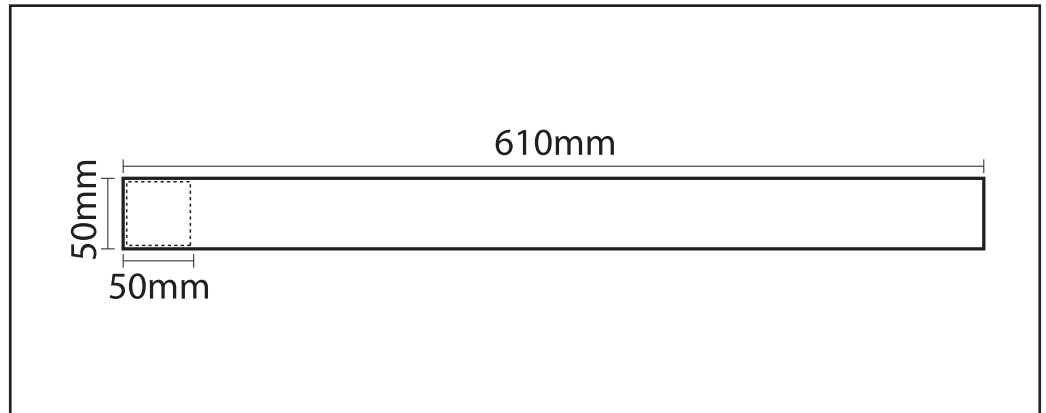

1. The velcro should be wrapped beneath the step—on and around the back legs closest to the bed.

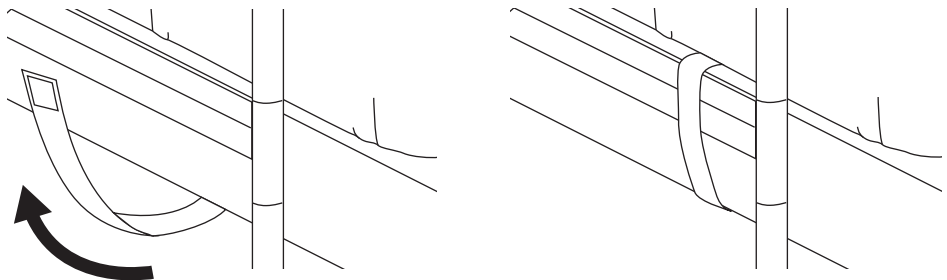

2. Next, wrap the other end around the bed frame, securely fastening the velcro ensuring a firm grip.

