

**LUMEX<sup>®</sup>**



## **LF1600 Stand Assist Assembly and Operation Manual**

**LF1600-INS-LAB-RevE15  
© 2007 GF Health Products, Inc.**

**LF1600 Stand Assist user and attendant: Read this manual before operating the Stand Assist. Save this manual for future reference.**

---

**⚠ WARNING: LF1600 Stand Assist attendant: Do not operate the LF1600 Stand Assist without first reading and understanding this manual. If you do not understand the warnings, cautions, and instructions provided herein, contact your professional medical advisors, GF authorized distributor, or technical representative before proceeding with the use of this product; otherwise personal injury or damage to your Stand Assist could result.**

## **CONTENTS**

<b>1</b>	<b>INTRODUCTION.....</b>	<b>3</b>
	<b>INTENDED USE .....</b>	<b>3</b>
<b>2</b>	<b>SAFETY PRECAUTIONS.....</b>	<b>4</b>
	<b>SIGNIFICANCE OF SAFETY STATEMENTS.....</b>	<b>4</b>
	<b>WARNINGS .....</b>	<b>4</b>
<b>3</b>	<b>HANDLING PROCEDURES.....</b>	<b>5</b>
	<b>SHIPPING AND TRANSPORTATION INSTRUCTIONS.....</b>	<b>5</b>
<b>4</b>	<b>FEATURES .....</b>	<b>6</b>
	<b>COMPONENTS .....</b>	<b>6</b>
	<b>FASTENERS AND TOOLS .....</b>	<b>6</b>
<b>5</b>	<b>ASSEMBLY INSTRUCTIONS.....</b>	<b>7</b>
<b>6</b>	<b>OPERATION .....</b>	<b>10</b>
<b>7</b>	<b>MAINTENANCE.....</b>	<b>12</b>
	<b>CLEANING THE STAND ASSIST.....</b>	<b>12</b>
<b>8</b>	<b>LIMITED WARRANTY .....</b>	<b>13</b>
<b>9</b>	<b>INDEX .....</b>	<b>15</b>

GF Health Products, Inc. is not responsible for typographical errors. For the most updated and current information on packaging, warranties, products and specifications, including the most current version of these instructions, please visit our website at [www.grahamfield.com](http://www.grahamfield.com). **Graham-Field** and **Lumex** are registered trademarks of GF Health Products, Inc.

# 1 INTRODUCTION

Important safety, operating, and maintenance instructions that warrant your attention are included in this manual. Read the entire manual carefully before operating your new LF1600 Stand Assist, keep it handy for future reference, and refer to it as often as necessary to help maintain good performance standards.

The Lumex Stand Assist is a manual standing aid that requires patients to assist themselves in preparation for transport. Patients qualified to use the Stand Assist must have adequate arm strength to pull themselves upward and enough leg strength to support their own weight. Patients who meet these criteria and have difficulty walking will find the Stand Assist a useful transport device. Functionally, the Stand Assist is positioned between a traditional walker and a battery powered sit-to-stand lift. The Stand Assist is a convenient toileting alternative to a wheelchair. Once the resident has positioned themselves on board, the split seat can be positioned to allow the resident to sit comfortably while a caregiver performs the transport. For residents lacking the strength to assist themselves, we recommend a battery powered sit-to-stand lift.

The Stand Assist is capable of the following transfers when used according to the instructions:

- Bed to chair/wheelchair
- Bed/chair/wheelchair to commode
- Room to room

The safety precautions in this manual are general warnings intended to be used only as basic guidelines. You may find it necessary to develop your own methods for safely solving frequently encountered challenges. Again, consult your professional medical advisors for their recommendations about safety methods, and never hesitate to ask for their assistance.

All information and specifications in this manual are current at the time of printing.

## INTENDED USE

The Lumex Stand Assist's intended use is as a transport assistance unit.

### Contraindication

The Lumex Stand Assist is intended for use by residents who have the strength and stability to lift and support themselves. We recommend a battery powered sit-to-stand lift for residents with limited strength and stability.

**⚠ WARNING: Personal injury - this device is designed for transport assistance of individuals between approximately 5'1" and 6'6" (155 cm and 198 cm) in height. Ensure the LF1600 properly fits the individual being transferred before use.**

## 2 SAFETY PRECAUTIONS

- ⚠ WARNING: Always follow these safety precautions when using your LF1600 Stand Assist. Failure to do so could result in personal injury to you or others or damage to the Stand Assist.**

Safety requires the constant attention of the Stand Assist user and attendant. It is extremely important to learn and always use safe methods of performing basic daily activities. Always consult your professional medical advisors to determine those methods most suitable for your individual abilities.

### SIGNIFICANCE OF SAFETY STATEMENTS

Please note the following special statements, used throughout this manual, and their significance:

- ⚠ WARNING: Indicates a potential hazard situation or unsafe practice that, if not avoided, could result in death or serious personal injury.**
- ⚠ CAUTION: Indicates a potential hazard situation or unsafe practice that, if not avoided, could result in minor or moderate personal injury.**
- ▲ NOTICE: Indicates a potential hazard situation or unsafe practice that, if not avoided, could result in product or property damage.**

*Info: Provides application recommendations or other useful information to ensure that you get the most from your product.*

### WARNINGS

- ⚠ WARNING: Only qualified caregivers trained in the proper use of the Stand Assist should use it to transport patients.**
- ⚠ WARNING: Do not use the Stand Assist to transport patients who are unable to pull themselves upright and support their own weight.**
- ⚠ WARNING: The LF1600 Stand Assist maximum weight capacity is 400 lb (180 kg), EVENLY DISTRIBUTED. Never use the Stand Assist to transport a patient whose weight exceeds 400 lb (180 kg).**
- ⚠ WARNING: Before using the Stand Assist for patient transport, check the Stand Assist to ensure all components are properly and securely assembled and in working order.**
- ⚠ WARNING: Do not leave a patient unattended during any part of the transport.**
- ⚠ WARNING: If components are damaged or missing, contact your GF authorized distributor immediately. DO NOT use substitute parts. Use only Lumex replacement parts. The use of non-Lumex replacement parts could cause personal injury, property damage, and void the warranty.**
- ⚠ WARNING: California Proposition 65 WARNING: This product contains a chemical known to the State of California to cause cancer and reproductive or developmental harm.**
- ⚠ WARNING: GF Health Products, Inc. specifically disclaims responsibility for any bodily injury or property damage which may occur during any use which does not comply with federal, state or local laws or ordinances.**

# 3 HANDLING PROCEDURES

## SHIPPING AND TRANSPORTATION INSTRUCTIONS

If the Stand Assist is to be reshipped by common carrier, it should be packed in the same carton in which it was received.

### Unpacking

**⚠ WARNING: The lift is heavy. To avoid personal injury, DO NOT attempt to remove the lift from the box without assistance.**

1. Check for any obvious damage to the carton or its contents. If damage is evident, notify the carrier or your GF authorized distributor.
2. Remove all loose packing from the carton.
3. Carefully remove all the components from the carton.

***Info: Unless the Stand Assist is to be used immediately, retain boxes, containers and packing material for use in storing until use of Stand Assist is required.***

### Inspection





1. Examine the exterior of the Stand Assist for nicks, dents, scratches or other damage.
2. Inspect all components.

### Storage



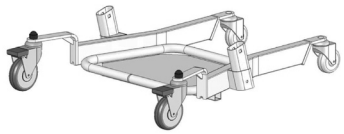





1. Store the repackaged Stand Assist in a dry area.
2. DO NOT place other objects on top of the repackaged Stand Assist.

# 4 FEATURES

## COMPONENTS

Item	Description	Quantity
	Base preassembled with footplate and casters	1
	Side support arm unit	2
	Kneepad assembly	1
	Seat pad and handle bar support unit with cross bar tube	2

## FASTENERS AND TOOLS

No.	Item	Description	Quantity
A1		Carriage bolt	8
A2		Hex bolt	2
A3		Button socket head cap screw	4
A4		Flat washer	10
A5		Lock washer	10
A6		Acorn nut	8
A7		Plastic cap	2
T1		Wrench	1
T2		Hex key	1

# 5 ASSEMBLY INSTRUCTIONS

Tools required: provided wrench, provided hex key

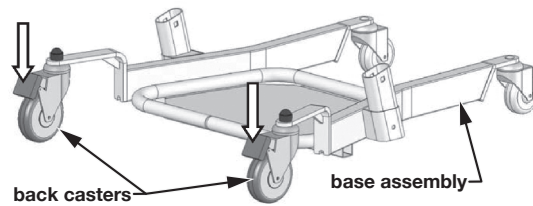

1. Place the base assembly on the floor and lock the back casters for ease of assembly, as shown above.

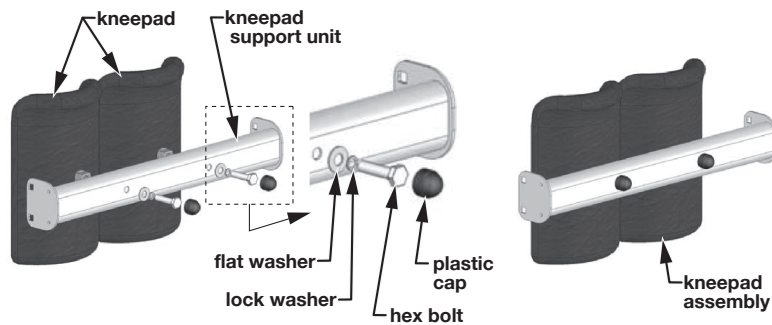

2. Insert the kneepads into the kneepad support unit. Install the two hex bolts through lock washers, flat washers, and kneepad support unit into nuts as shown above. Tighten securely with the provided wrench. Install the two plastic caps on the hex bolts. The finished assembly is shown at right above.

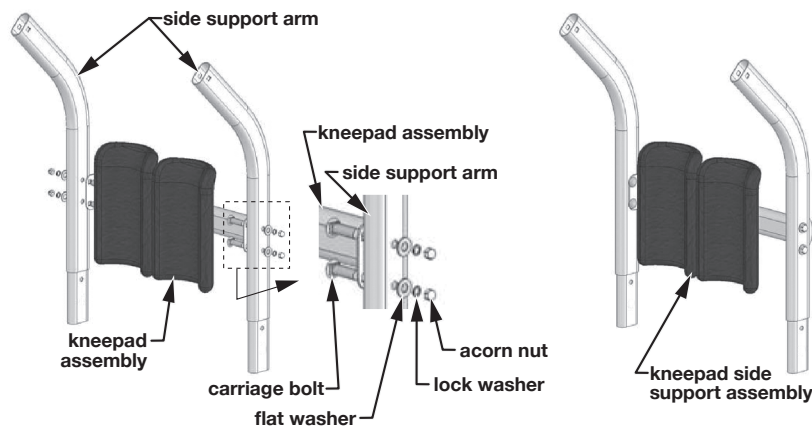

3. Attach the kneepad assembly to the two side support arms. Face the square holes on the side support arms inward; fit the square shoulder of each carriage bolt in the square hole, installing each carriage bolt through the kneepad assembly bracket and side support arm from the inside as shown above. Install the flat washer, lock washer, and acorn nut on the end of each carriage bolt as shown above. Do not tighten the nuts; some play in this assembly will be needed to assemble the entire unit. The finished assembly is shown at right above.

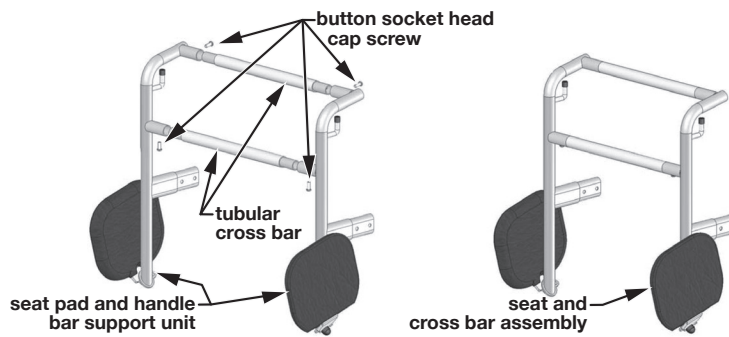

4. Insert the two tubular cross bars into the holes on the seat pad and handle bar support units as shown above. Align the small holes on the cross bar undersides with the holes in the support units. Install the four button socket head cap screws through the support units into the cross bars. Use the hex key to tighten. The finished assembly is shown at right above.

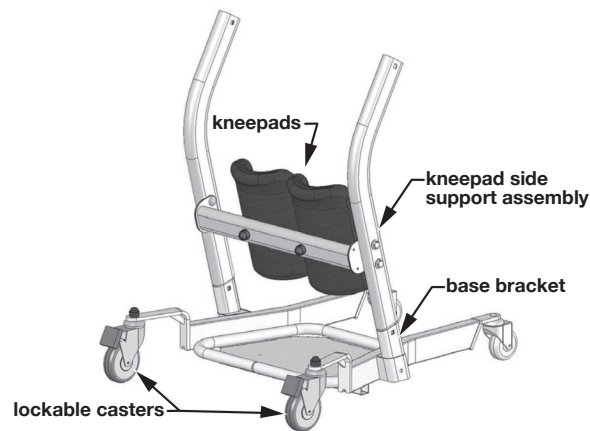

5. Insert the kneepad side support assembly into the base brackets as shown above. The kneepads and arm curvature should be facing away from the lockable casters.

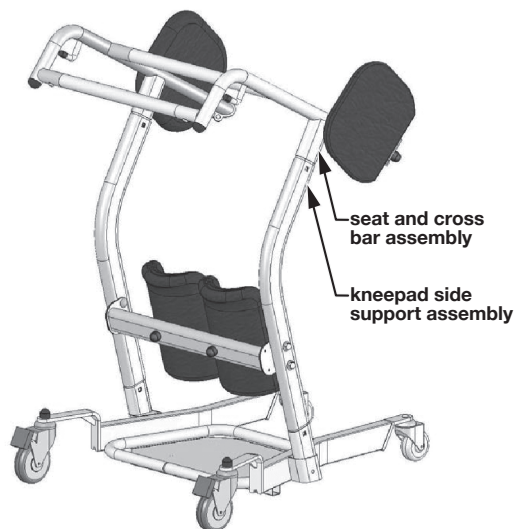

6. Insert the seat and cross bar assembly into the tubes at the top of the kneepad side support assembly as shown above.



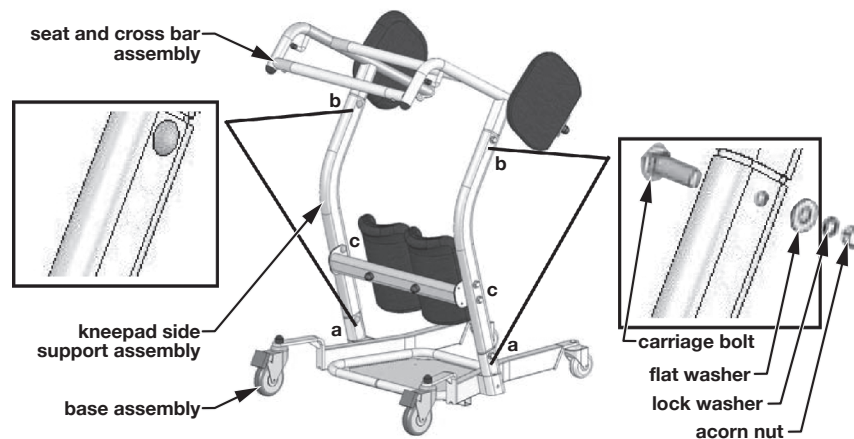

7. Fasten the seat and cross bar assembly, kneepad side support assembly, and base assembly together with carriage bolts:
  - a. Attach the kneepad side support assembly to the base assembly. Fit the square shoulder of each carriage bolt in the square hole at inside of base bracket, installing each carriage bolt through the base and kneepad side support assembly as shown above. Install the flat washer, lock washer, and acorn nut on the end of each carriage bolt as shown above. Tighten the two nuts securely using the provided wrench.
  - b. Attach the seat and cross bar assembly to the kneepad side support assembly. Fit the square shoulder of each carriage bolt in the square hole at inside of kneepad side support assembly, installing each carriage bolt through the kneepad side support assembly and seat and cross bar assembly as shown above. Install the flat washer, lock washer, and acorn nut on the end of each carriage bolt as shown above. Tighten the two nuts securely using the provided wrench.
  - c. Securely tighten the four nuts that attach the kneepad assembly to the two side support arms, installed in step 3, using the provided wrench.

**⚠ WARNING: Before operating the Stand Assist, ensure that all components are properly and securely assembled and that all fasteners are secure.**

**⚠ WARNING: Before operating the Stand Assist, read the operation instructions.**

## 6 OPERATION

*Info: Patients who desire additional security may wish to use the optional DSLSA9 Sit-to-Stand Buttock Strap, available through your GF authorized distributor.*

The split seat units can be rotated upward to allow for patient loading then, once the patient is in an upward standing position, lowered to form a complete two-sided seat.

**⚠ WARNING: Ensure that both seat units are fully lowered and form a complete seat before having the patient sit down on the Stand Assist.**

**⚠ WARNING: Do not leave a patient unattended during any part of the transport.**

1. Raise the two split seat units so that they are parallel to the side of the Stand Assist, as shown at right.



2. Have the patient positioned at the edge of the surface to be transferred from. Move the Stand Assist in front of the patient. Position the patient so that her feet are firmly on the platform and her knees and shins are in contact with the two cupped kneepads, as shown at right.



3. Lock the casters by stepping on the caster clip and pushing down, as shown at right.



4. Have the patient grasp the cross bar closest to her and, using her own strength, pull herself up into a standing position securely on the base platform, as shown at right.



5. Lower both of the split seat units down into position to form a complete seat, as shown at right.

**⚠ WARNING: Ensure that both seat units are lowered and form a complete seat before having the patient sit down on the Stand Assist.**



6. Have the patient lower herself down onto the seat while keeping her knees and shins in the kneepads, and while continuing to hold the cross bar with both hands, as shown at right.



7. Unlock the casters. Place both hands on the cross bar furthest from the patient, as shown at right, and move the Stand Assist to the new surface. Ensure that the patient is secure and in proper position as described in Step 6 before and during transfer, as shown at right.
8. Position the Stand Assist against the new surface, ensuring that the patient will be in a position to sit down firmly and safely on the transfer surface.
9. Lock the casters.
10. Have the patient pull herself back up to a full standing position.
11. Raise the two split seat units so that they are parallel to the side of the Stand Assist, as shown at right, to allow the patient to lower herself.
12. Stand beside the patient as she lowers herself down onto the new surface.
13. Ensure that the patient is safely positioned. Unlock the casters and move the Stand Assist to storage.

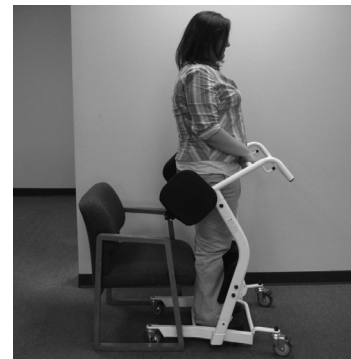

# 7 MAINTENANCE

To ensure safety and proper use, perform the following steps monthly:

- Check all fasteners to ensure that they are securely fastened and no wear and tear is evident. Replace and tighten any worn fasteners before using the Stand Assist.
- Check the two seat assemblies to make sure they are not worn or damaged, and that the bolts are tight. Replace any worn or damaged seat components before using the Stand Assist.
- Check the casters to make sure they are in working order and are secured firmly to the Stand Assist. Replace any worn or damaged casters before using the Stand Assist.

If any maintenance procedure is not clear to you, ask your GF authorized distributor for assistance.

**▲ NOTICE: Improper maintenance can cause operating problems and may affect your warranty.**

**⚠ WARNING: Unauthorized modification or the use of non-Lumex replacement parts could change the structure of the Stand Assist, void the warranty, and create a hazardous condition resulting in serious personal injury.**

## CLEANING THE STAND ASSIST

- Wipe off the frame at least once a week with a soft cloth. Dry the Stand Assist immediately if exposed to moisture.
- Clean the frame every three months with a mild soap and water solution. The frame does not need to be waxed.
- Clean upholstery and plastic components at least once a month with a mild soap and water solution.

**▲ NOTICE: Do not use solvents, abrasive waxes, caustic chemicals or spray silicone to clean the Stand Assist.**

**▲ NOTICE: Do not use abrasive cleansers to clean the Stand Assist; they could scratch the finish.**

**▲ NOTICE: Do not use steam or high pressure cleaners to clean the Stand Assist.**

## **8 LIMITED WARRANTY**

### **SCOPE OF WARRANTY**

GF Health Products, Inc. (“GF”) warrants to the original purchaser only that it will replace or repair components, at GF’s sole discretion, that are defective in material or workmanship under normal use and service. All warranties are conditioned upon the proper use of the products strictly in accordance with good commercial practice and applicable GF instructions and manuals, including proper use and maintenance. To the extent that a component is warranted by a third party, GF conveys all of its rights under that warranty to the original purchaser, to the extent permitted. This limited warranty shall only apply to defects that are reported to GF’s customer service team within the applicable warranty period and which, upon examination by GF or its authorized representative, prove to be a warranty item. This limited warranty is not transferable.

The warranted components and time period are set forth below:

Frame:	three years
Parts, including casters:	one year

The applicable warranty period shall commence from date of shipment to the original customer, unless there is an expiration date on the component in which case the warranty shall expire on the earlier of warranty period or the expiration date.

### **OBTAINING WARRANTY SERVICE**

This limited warranty shall only apply to defects that are reported to the Distributor from whom the Customer purchased the product within the applicable warranty period. If there is not a Distributor, you must contact GF directly by calling 770-368-4700, sending a fax request to 770-368-2386, or by e-mailing a request to [cs@grahamfield.com](mailto:cs@grahamfield.com). Specific directions will be provided by the Customer Service Representative. Failure to abide by the specific directions will result in denial of the warranty claim.

The warranty does not cover and GF shall not be liable for the following:

- 1) Defects, damage, or other conditions caused, in whole or in part, by misuse, abuse, negligence, alteration, accident, freight damage, tampering or failure to seek and obtain repair or replacement in a timely manner;
- 2) Products which are not installed, used, or properly cleaned and maintained as required in the official manual for the applicable product;
- 3) Products considered to be of a non-durable nature including, but not limited to: filters, fuses, gaskets, lubricants, and charts;
- 4) Accessories or parts not provided by GF;
- 5) Charges by anyone for adjustments, repairs, replacement parts, installation or other work performed upon or in connection with such products which are not expressly authorized in writing, in advance, by GF;

- 6) Any labor or shipping charges incurred in the replacement part installation or repair;
- 7) Costs and expenses of regular maintenance and cleaning; and
- 8) Representations and warranties made by any person or entity other than GF.

### **ENTIRE WARRANTY, EXCLUSIVE REMEDY AND CONSEQUENTIAL DAMAGES DISCLAIMER**

THIS WARRANTY IS GF'S ONLY WARRANTY AND IS IN LIEU OF ALL OTHER WARRANTIES, EXPRESS OR IMPLIED. GF MAKES NO IMPLIED WARRANTIES OF ANY KIND INCLUDING ANY IMPLIED WARRANTIES OF MERCHANTABILITY OR FITNESS FOR A PARTICULAR PURPOSE. IF ANY MODEL OR SAMPLE WAS SHOWN TO THE CUSTOMER, SUCH MODEL OR SAMPLE WAS USED MERELY TO ILLUSTRATE THE GENERAL TYPE AND QUALITY OF THE PRODUCT AND NOT TO REPRESENT THAT THE PRODUCT WOULD NECESSARILY CONFORM TO THE MODEL OR SAMPLE IN ALL RESPECTS. THIS WARRANTY IS LIMITED TO THE REPAIR OR REPLACEMENT OF THE DEFECTIVE PARTS. GF SHALL NOT BE LIABLE FOR AND HEREBY DISCLAIMS ANY DIRECT, SPECIAL, INDIRECT, INCIDENTAL, EXEMPLARY OR CONSEQUENTIAL DAMAGES, INCLUDING, BUT NOT LIMITED TO: DAMAGES FOR LOSS OF PROFITS OR INCOME, LOSS OF USE, DOWNTIME, COVER, OR EMPLOYEE OR INDEPENDENT CONTRACTOR WAGES, PAYMENTS AND BENEFITS.

The warranties contained herein contain all the representations and warranties with respect to the subject matter of this document, and supersede all prior negotiations, agreements and understandings with respect thereto. The recipient of this document hereby acknowledges and represents that it has not relied on any representation, assertion, guarantee, warranty, collateral contract or other assurance, except those set out in this document.

For additional information on this product or this warranty, please contact a GF Customer Service Representative.

### **NOTES:**

- 1) Additional terms and conditions may apply.
- 2) Freight claims must be notated on the appropriate shipping documents and must be made with immediacy. International, federal and state regulations govern specific requirements for freight claims. Failure to abide by those regulations may result in a denial of the freight claim. GF will assist you in filing the freight claim.
- 3) Claims for any short shipment must be made within thirty (30) days of the invoice date.

# 9 INDEX

## A

Assembly instructions 7

## C

CAUTION statement, significance 4

Cleaning the Stand Assist 12

Components, identification 6

## F

Fasteners and tools, identification 6

Features 6

## H

Handling Procedures 5

## I

Info statement, significance 4

Inspection 5

Intended use 3

Introduction 3

## M

Maintenance 12

## N

NOTICE statement, significance 4

## O

Operation 10

## S

Safety precautions 4

Safety statements, significance of 4

Shipping and transportation instructions 5

Significance of safety statements 4

Sit-to-Stand Buttock Strap, optional 10

Storage 5

## T

Tools required for assembly, list 7

Transport, perform 10

## U

Unpacking 5

## W

Warnings 4

WARNING statement, significance 4

Warranty 13

Weight capacity 4

Weight capacity, maximum 4



**GRAHAM-FIELD**

---

**Made in Taiwan**