

# TITAN BALANCE ASSIST POLE with SafetyGrip®

SG600

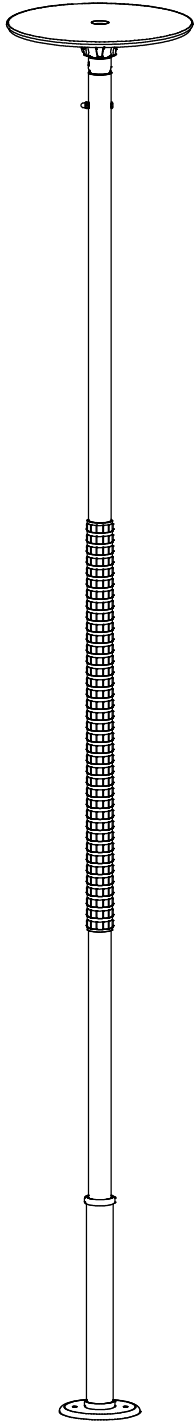

## Table of Contents

- Warnings and Cautions for Poles (2 Pages)
- TSG600 Installation Instructions (6 Pages)

## Specifications:

- Product Name: Titan Pole
- Product#: SG600
- Maximum User Weight: 300lbs (136kg)

# KIT CONTENTS



① TOP POLE TUBE



② BOTTOM POLE TUBE

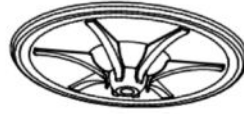

③ CEILING DISC with GASKET



④ FLOOR BASE with GASKET



⑤ BOTTOM COVER TUBE



⑥ CONNECTING TUBE

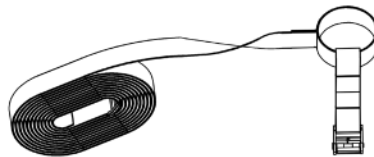

⑦ SAFETY RETENTION STRAP KIT  
( in small carton)



ADJUSTING BAR



LEVEL

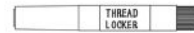

THREAD LOCKER

# ASSEMBLY & INSTALLATION

## Product Information and Specifications

Titan Poles feature our patented interlocking SafetyGrip® and the long-lasting protection of embedded antimicrobial AlphaSan® RC5000 silver ions powder for all parts except hardware.

- This Titan Pole is an assistive balance and mobility product. It is designed to assist with sit-up, reposition, balance, stand or transfer.
- Maximum weight capacity of the Titan Pole is 300 lbs (136 kgs) and it is **not designed** to support the full weight of the user.
- For users over 300 lbs, our Titan Pole SG650 has a maximum weight capacity of 500 lbs (230 kgs).
- Titan Poles have 6 inches of height adjustment and are designed for installation where the ceiling height is between 7'-9" to 8'-3" (235 -250 cm).
- For higher ceilings use our SG604 Height Adjustment Kit.

## STEP 1: Apply Thread Locker to the Top Pole Tube Screw

Apply Thread locker to the threaded screw at the top of the Top Pole Tube-1 as shown in the view below.

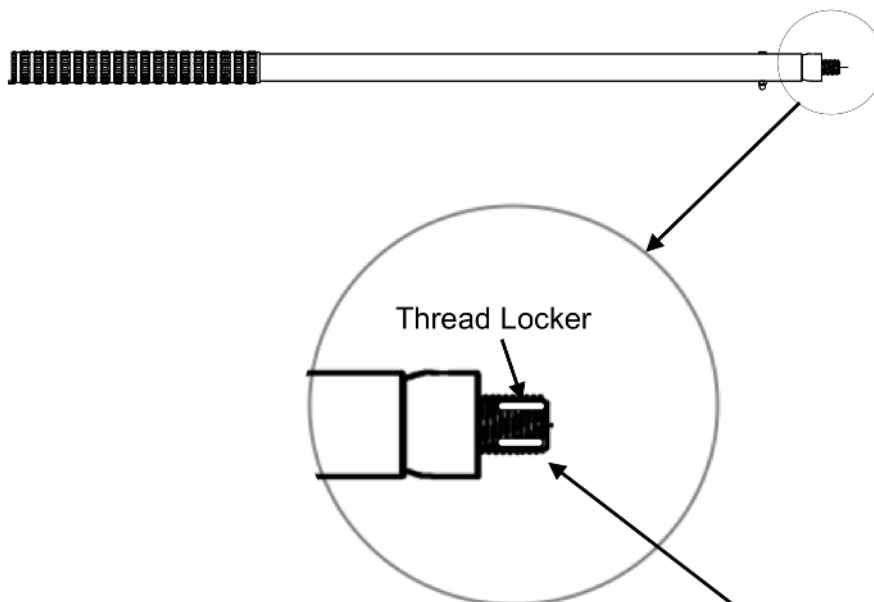

Apply 3 lines of thread locker equally around the screw threads as shown.

NOTE: Any excess thread locker can be wiped clean with a cloth or paper towel.

Now follow STEP 2.

STEP 1

## STEP 2: Join the Ceiling Disc-3 with the Top Pole Tube-1

Put the Ceiling Disc-3 on the floor. Take the Top Pole Tube-1 and screw it into the Ceiling Disc-3 clockwise and tighten firmly.

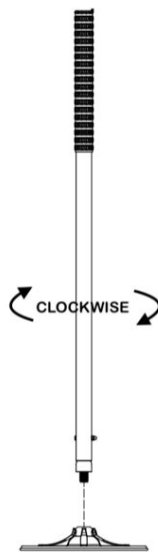

STEP 2

## IMPORTANT: To use this Pole with a Bed

If you are installing this Titan Pole for use with a Bed open the Pole Retention Safety Strap carton and also follow the Installation Instructions included with this Kit.

Now is the time to slide the Strap onto the bottom of the Pole.

## STEP 3: Join the Top Pole Tube-1 and the Bottom Pole Tube-2

Join the Top Pole Tube-1 and Bottom Pole Tube-2 by inserting the Connection Tube-6 into both.

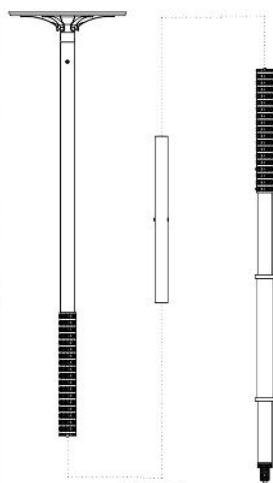

STEP 3

**INSTALLER CAUTION:** It is important to make sure that the inter-connecting slots in the Pole Tubes are correctly lined up.

Slide the Bottom Cover Tube-5 onto the Bottom Pole Tube-2. Place the Bottom Pole Tube-2 into the floor base.

You are now ready to stand your Titan Pole up into the position that you want it.

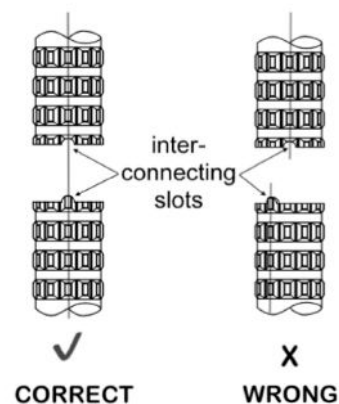

## STEP 4: Titan Pole Height Adjustment and Alignment

- A. Slide the Bottom Cover Tube-5 up out of your way while you are doing this step.
- B. You can adjust the height of the Titan Pole by turning the screw until the Ceiling Disc-3 is touching your ceiling. Use the Adjusting Bar supplied to help you do this. Before you finally tighten the Titan Pole check that it is perpendicular (90 degrees) to the floor in all directions. This is very important - use the level supplied. When it is perpendicular and where you want it to be, tighten the Titan Pole between the Floor and Ceiling using the Adjustment Bar.

**INSTALLER CAUTION:** Do not over tighten the Titan Pole because it can damage your ceiling.

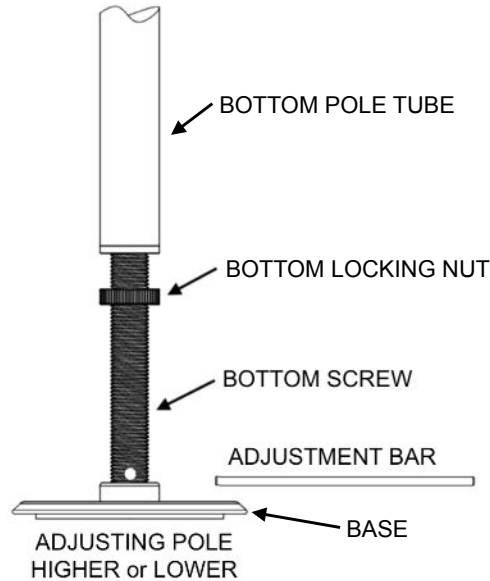

**STEP 4**

## STEP 5: Fixing the Floor Base to the Floor

The Titan Pole base can be fixed permanently onto the floor with two fasteners (Not Supplied). This will provide a more secure installation.

## STEP 6: Final Checks

Ensure the Titan Pole is safe and secure by grasping the Titan Pole mid-height then push and pull vigorously. The Ceiling Disc-3 and Floor Base -4 should not slide or move if the Titan Pole is tensioned correctly. If the Ceiling Disc-3 or Floor Base-4 moves or slips in any way, increase tension on the pole by tightening the screw. Double check that the Titan Pole is still perpendicular. When the Titan Pole is tight and secure, tighten the Locking Nut against the bottom of the Titan Pole Tube. Slide the Bottom Cover Tube-5 down over the screw.

# MAINTENANCE AND CLEANING

- **VERY IMPORTANT:** It is important to inspect the Product(s) frequently.
- Stop using immediately if damaged or broken, or if parts are missing.
- Stop using immediately if Product(s) shift out of the original installed position(s) until they are readjusted into the correct position.
- To clean your Titan pole, use a damp cloth with soap and water or mild household cleaner, wipe clean and dry before using.



Hartmobility reserves the right to update and revise our products. Refer to our website for the most up-to-date version of this document.