

**CHAIR INFORMATION**

**SABER K0005**  
**Max. Capacity 250Lbs**

NOTE  
**Main Frame : ZK55 & ZK60 High Grade A7000 Series Aluminum**  
**Main Frame : Lifetime Warranty(5 YEARS)**  
\*See warranty policy

**A FRAME COLORS & PARTS COLORS**

**FRAME COLORS**

- |   |   |   |   |  |   |   |
|---|---|---|---|--|---|---|
| <input type="checkbox"/> Powder-Coated  | <input type="checkbox"/> Gloss Black      | <input type="checkbox"/> Twilight Flake       | <input type="checkbox"/> Yellow           | <input type="checkbox"/> Magenta       | <input type="checkbox"/> Fire Engine Red  | <input type="checkbox"/> White          |
| <input type="checkbox"/> Neon Yellow    | <input type="checkbox"/> Candy Blue       | <input type="checkbox"/> Candy Purple         | <input type="checkbox"/> Candy Green      | <input type="checkbox"/> Candy Red     | <input type="checkbox"/> Candy Raspberry  | <input type="checkbox"/> Cobalt Blue    |
| <input type="checkbox"/> Brass Metallic | <input type="checkbox"/> Matte Gray       | <input type="checkbox"/> Matte Purple         | <input type="checkbox"/> Matte Blue       | <input type="checkbox"/> Matte Green   | <input type="checkbox"/> Matte Black      | <input type="checkbox"/> Matte Red      |
| <input type="checkbox"/> Tiffany Blue   | <input type="checkbox"/> Neon Red         | <input type="checkbox"/> Neon Green           | <input type="checkbox"/> Orange Sparkle   | <input type="checkbox"/> Mellon Yellow | <input type="checkbox"/> Gun Smoke Silver | <input type="checkbox"/> Shocker Yellow |
|   | <input type="checkbox"/> Sparkle Burgundy | <input type="checkbox"/> Granny Sparkle Green | <input type="checkbox"/> Sparkle Sky Blue | <input type="checkbox"/> Reed Green    | <input type="checkbox"/> Blue Lilac       |   |

- Special Colors**
- Polished . . . . .
- 24 karat Gold . . . . .

**PARTS COLORS**

**STD Color** Black Color (\*Suspension Springs-Silver Color Only)-

- |   |                          |  |
|---|--------------------------|--|
| <b>Custom Color Main Bolt on Parts</b>  | <b>One Color Package</b> | <input type="checkbox"/> Powder-Coated ( )       |
| Includi Backrest, Foot Plate, Footrest Rings, Backrest Brackets , Saddle Stops  |                          | <input type="checkbox"/> Polished . . . . .      |
| Forks & Knurl Nuts, Caps, Front Suspension Springs, Axle Tube, Axle Clamps, Axle Plates, Axle Bases, Camber Discs ☆marked parts |                          | <input type="checkbox"/> 24 karat Gold . . . . . |

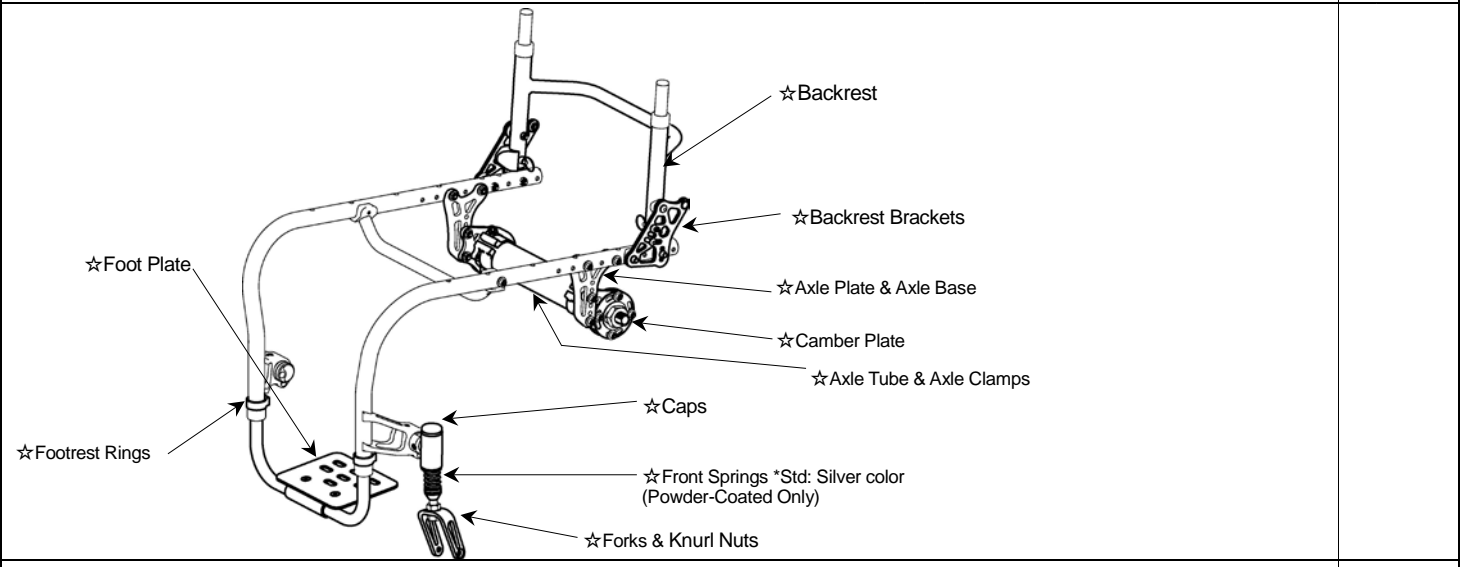

**B FRAME MEASUREMENTS 1/2**

\*DETAILED MEASURING GUIDE IN BACK OF ORDER FORM

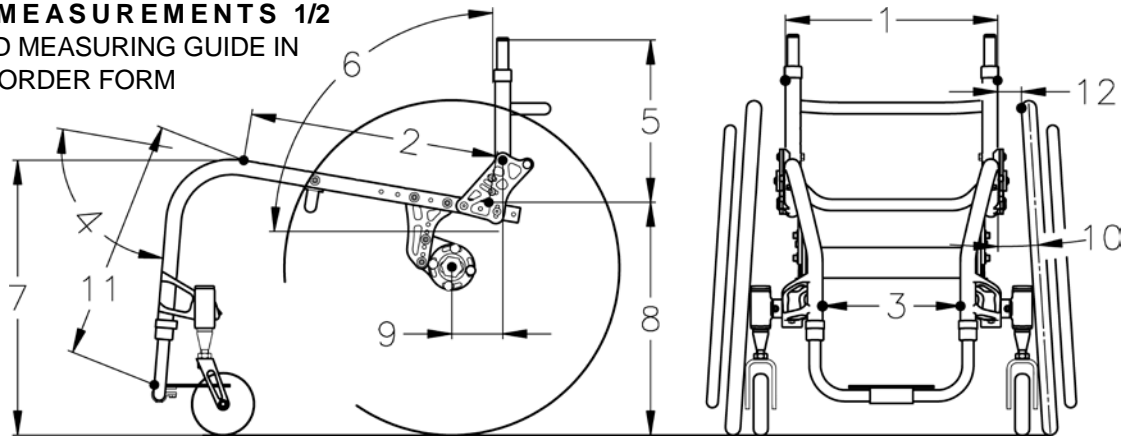

<b>1. SEAT WIDTH</b>	<input type="checkbox"/> 14" <input type="checkbox"/> 15" <input type="checkbox"/> 16" <input type="checkbox"/> 17" <input type="checkbox"/> 18" <input type="checkbox"/> 19" .....
----------------------	---

<b>2. SEAT DEPTH</b>	<b>Depth Adj. Frame</b> <input type="checkbox"/> <b>Short Frame</b> (16" Depth)    Set at <input type="checkbox"/> 14" <input type="checkbox"/> 15" <input type="checkbox"/> 16" ..... <input type="checkbox"/> <b>Long Frame</b> (19" Depth)    Set at <input type="checkbox"/> 17" <input type="checkbox"/> 18" <input type="checkbox"/> 19" .....
----------------------	---

<b>3. FOOTREST WIDTH</b>	<input type="checkbox"/> <b>STD</b> (Seat Width Minus 5", Taper on Bottom Frame) ..... *No Custom Modifications
--------------------------	--

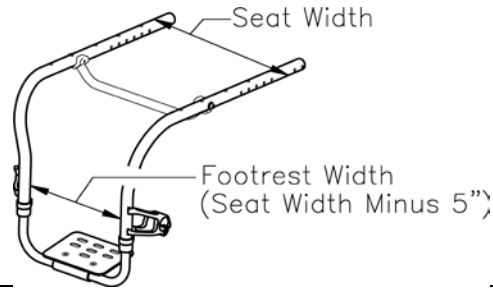

**Aluminum Seat Pan**

**E2231**

<b>FOOT PLATE STYLE</b>	<input type="checkbox"/> <b>Standard single loop</b> with adjust. height & angle. STD Foot Plate ..... <b>K0040</b> <input type="checkbox"/> <b>Single Flip-Back-single loop</b> (no riser avail) with adjust. height & angle. STD Foot Plate ..... <b>K0040</b>
-------------------------	---

STD Foot Plate Size Chart

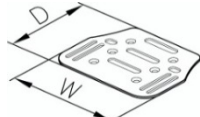

Your Seat Width	Foot Plate Size
14"-15"	W6.5"xD5"
16"-18"	W8.5"xD6.5"
19"	W11"xD6.5"

\*No Custom Modifications

**Foot Propel w/ Bolt On Stabilizer Bar Style (\$250 up charge)**

**Dual Flip Up Footrest w/ Bolt On Stabilizer Bar Style (\$250 up charge)**

<b>4. FRAME BEND ANGLE</b>	<input type="checkbox"/> 95° only    *No Custom Modifications .....
----------------------------	---

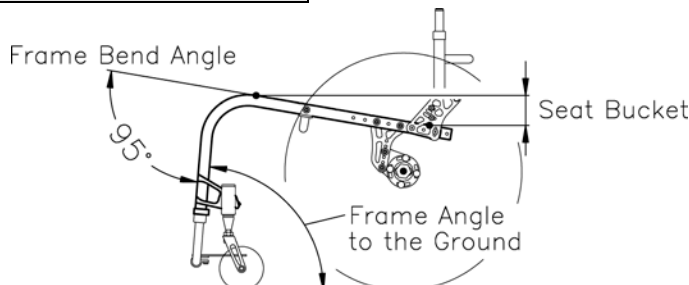

**FRAME ANGLE to the Ground**

		Your Seat Depth					
		14"	15"	16"	17"	18"	19"
Seat Bucket	0"	95°	95°	95°	95°	95°	95°
	1"	91°	91°	91°	92°	92°	92°
	2"	87°	87°	88°	88°	89°	89°
	3"	83°	83°	84°	85°	85°	86°
	4"	78°	80°	81°	81°	82°	83°
	5"	74°	76°	77°	78°	79°	80°

## B FRAME MEASUREMENTS 2/2

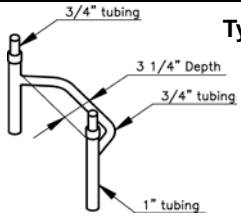
<b>5. BACKREST HEIGHT</b> <small>* Rigidizer bar 3.25" deep std.</small>	<input type="checkbox"/> 8" <input type="checkbox"/> 9" <input type="checkbox"/> 10" <input type="checkbox"/> 11" <input type="checkbox"/> 12" <input type="checkbox"/> 13" <input type="checkbox"/> 14" <input type="checkbox"/> 15" <input type="checkbox"/> 16" <input type="checkbox"/> 17" <input type="checkbox"/> 18"																																																																																																																		
	<b>Type</b> <input type="checkbox"/> <b>Locking mechanism</b> with adjust. height & angle ..... <input type="checkbox"/> <b>Double Locking mechanism</b> with adjust. height & angle ..... <input type="checkbox"/> <b>Folding with adjust.</b> height & angle ..... *No Custom Modifications																																																																																																																		
<b>6. BACKREST ANGLE</b>	Set at (                      °) to the ground *STD 90°																																																																																																																		
<b>7. FRONT SEAT HEIGHT</b>	<input type="checkbox"/> 16.5" <input type="checkbox"/> 17.0" <input type="checkbox"/> 17.5" <input type="checkbox"/> 18.0" <input type="checkbox"/> 18.5" <input type="checkbox"/> 19.0" <input type="checkbox"/> 19.5" <input type="checkbox"/> 20.0" <input type="checkbox"/> 20.5"																																																																																																																		
STD Front Seat Height Ran No Custom Modifications  * =Not Available with Quick	The front seat heights are impacted by the size of your front caster. <table border="1" style="width:100%; border-collapse: collapse; text-align: center;"> <thead> <tr> <th colspan="2" rowspan="2"></th> <th colspan="10">Front Seat Height</th> </tr> <tr> <th>16.5"</th><th>17.0"</th><th>17.5"</th><th>18.0"</th><th>18.5"</th><th>19.0"</th><th>19.5"</th><th>20.0"</th><th>20.5"</th> </tr> </thead> <tbody> <tr><td rowspan="8" style="writing-mode: vertical-rl; transform: rotate(180deg);">Your Casters &amp; Forks</td><td>3" Caster &amp; STD Forks</td><td><input type="checkbox"/>*</td><td><input type="checkbox"/></td><td><input type="checkbox"/></td><td><input type="checkbox"/></td><td><input type="checkbox"/></td><td><input type="checkbox"/></td><td><input type="checkbox"/></td><td><input type="checkbox"/></td><td><input type="checkbox"/></td></tr> <tr><td>3" Caster &amp; Springs</td><td><input type="checkbox"/>*</td><td><input type="checkbox"/></td><td><input type="checkbox"/></td><td><input type="checkbox"/></td><td><input type="checkbox"/></td><td><input type="checkbox"/></td><td><input type="checkbox"/></td><td><input type="checkbox"/></td><td><input type="checkbox"/></td></tr> <tr><td>3" Caster &amp; Frog Legs</td><td><input type="checkbox"/></td><td><input type="checkbox"/></td><td><input type="checkbox"/>*</td><td><input type="checkbox"/>*</td><td><input type="checkbox"/>*</td><td><input type="checkbox"/>*</td><td><input type="checkbox"/>*</td><td><input type="checkbox"/>*</td><td><input type="checkbox"/></td></tr> <tr><td>4" Caster &amp; STD Forks</td><td><input type="checkbox"/>*</td><td><input type="checkbox"/></td><td><input type="checkbox"/></td><td><input type="checkbox"/></td><td><input type="checkbox"/></td><td><input type="checkbox"/></td><td><input type="checkbox"/></td><td><input type="checkbox"/></td><td><input type="checkbox"/></td></tr> <tr><td>4" Caster &amp; Springs</td><td><input type="checkbox"/></td><td><input type="checkbox"/></td><td><input type="checkbox"/></td><td><input type="checkbox"/></td><td><input type="checkbox"/></td><td><input type="checkbox"/></td><td><input type="checkbox"/></td><td><input type="checkbox"/></td><td><input type="checkbox"/></td></tr> <tr><td>4" Caster &amp; Frog Legs</td><td><input type="checkbox"/></td><td><input type="checkbox"/></td><td><input type="checkbox"/>*</td><td><input type="checkbox"/>*</td><td><input type="checkbox"/>*</td><td><input type="checkbox"/>*</td><td><input type="checkbox"/>*</td><td><input type="checkbox"/>*</td><td><input type="checkbox"/></td></tr> <tr><td>5" Caster &amp; STD Forks</td><td><input type="checkbox"/></td><td><input type="checkbox"/>*</td><td><input type="checkbox"/>*</td><td><input type="checkbox"/>*</td><td><input type="checkbox"/></td><td><input type="checkbox"/></td><td><input type="checkbox"/></td><td><input type="checkbox"/></td><td><input type="checkbox"/>*</td></tr> <tr><td>5" Caster &amp; Springs</td><td><input type="checkbox"/></td><td><input type="checkbox"/></td><td><input type="checkbox"/></td><td><input type="checkbox"/>*</td><td><input type="checkbox"/>*</td><td><input type="checkbox"/>*</td><td><input type="checkbox"/>*</td><td><input type="checkbox"/>*</td><td><input type="checkbox"/>*</td></tr> <tr><td>5" Caster &amp; Frog Legs</td><td><input type="checkbox"/></td><td><input type="checkbox"/></td><td><input type="checkbox"/></td><td><input type="checkbox"/></td><td><input type="checkbox"/>*</td><td><input type="checkbox"/>*</td><td><input type="checkbox"/>*</td><td><input type="checkbox"/>*</td><td><input type="checkbox"/>*</td></tr> </tbody> </table>			Front Seat Height										16.5"	17.0"	17.5"	18.0"	18.5"	19.0"	19.5"	20.0"	20.5"	Your Casters & Forks	3" Caster & STD Forks	<input type="checkbox"/> *	<input type="checkbox"/>	<input type="checkbox"/>	<input type="checkbox"/>	<input type="checkbox"/>	<input type="checkbox"/>	<input type="checkbox"/>	<input type="checkbox"/>	<input type="checkbox"/>	3" Caster & Springs	<input type="checkbox"/> *	<input type="checkbox"/>	<input type="checkbox"/>	<input type="checkbox"/>	<input type="checkbox"/>	<input type="checkbox"/>	<input type="checkbox"/>	<input type="checkbox"/>	<input type="checkbox"/>	3" Caster & Frog Legs	<input type="checkbox"/>	<input type="checkbox"/>	<input type="checkbox"/> *	<input type="checkbox"/> *	<input type="checkbox"/> *	<input type="checkbox"/> *	<input type="checkbox"/> *	<input type="checkbox"/> *	<input type="checkbox"/>	4" Caster & STD Forks	<input type="checkbox"/> *	<input type="checkbox"/>	<input type="checkbox"/>	<input type="checkbox"/>	<input type="checkbox"/>	<input type="checkbox"/>	<input type="checkbox"/>	<input type="checkbox"/>	<input type="checkbox"/>	4" Caster & Springs	<input type="checkbox"/>	<input type="checkbox"/>	<input type="checkbox"/>	<input type="checkbox"/>	<input type="checkbox"/>	<input type="checkbox"/>	<input type="checkbox"/>	<input type="checkbox"/>	<input type="checkbox"/>	4" Caster & Frog Legs	<input type="checkbox"/>	<input type="checkbox"/>	<input type="checkbox"/> *	<input type="checkbox"/> *	<input type="checkbox"/> *	<input type="checkbox"/> *	<input type="checkbox"/> *	<input type="checkbox"/> *	<input type="checkbox"/>	5" Caster & STD Forks	<input type="checkbox"/>	<input type="checkbox"/> *	<input type="checkbox"/> *	<input type="checkbox"/> *	<input type="checkbox"/>	<input type="checkbox"/>	<input type="checkbox"/>	<input type="checkbox"/>	<input type="checkbox"/> *	5" Caster & Springs	<input type="checkbox"/>	<input type="checkbox"/>	<input type="checkbox"/>	<input type="checkbox"/> *	<input type="checkbox"/> *	<input type="checkbox"/> *	<input type="checkbox"/> *	<input type="checkbox"/> *	<input type="checkbox"/> *	5" Caster & Frog Legs	<input type="checkbox"/>	<input type="checkbox"/>	<input type="checkbox"/>	<input type="checkbox"/>	<input type="checkbox"/> *	<input type="checkbox"/> *	<input type="checkbox"/> *	<input type="checkbox"/> *	<input type="checkbox"/> *		
				Front Seat Height																																																																																																															
		16.5"	17.0"	17.5"	18.0"	18.5"	19.0"	19.5"	20.0"	20.5"																																																																																																									
Your Casters & Forks	3" Caster & STD Forks	<input type="checkbox"/> *	<input type="checkbox"/>	<input type="checkbox"/>	<input type="checkbox"/>	<input type="checkbox"/>	<input type="checkbox"/>	<input type="checkbox"/>	<input type="checkbox"/>	<input type="checkbox"/>																																																																																																									
	3" Caster & Springs	<input type="checkbox"/> *	<input type="checkbox"/>	<input type="checkbox"/>	<input type="checkbox"/>	<input type="checkbox"/>	<input type="checkbox"/>	<input type="checkbox"/>	<input type="checkbox"/>	<input type="checkbox"/>																																																																																																									
	3" Caster & Frog Legs	<input type="checkbox"/>	<input type="checkbox"/>	<input type="checkbox"/> *	<input type="checkbox"/> *	<input type="checkbox"/> *	<input type="checkbox"/> *	<input type="checkbox"/> *	<input type="checkbox"/> *	<input type="checkbox"/>																																																																																																									
	4" Caster & STD Forks	<input type="checkbox"/> *	<input type="checkbox"/>	<input type="checkbox"/>	<input type="checkbox"/>	<input type="checkbox"/>	<input type="checkbox"/>	<input type="checkbox"/>	<input type="checkbox"/>	<input type="checkbox"/>																																																																																																									
	4" Caster & Springs	<input type="checkbox"/>	<input type="checkbox"/>	<input type="checkbox"/>	<input type="checkbox"/>	<input type="checkbox"/>	<input type="checkbox"/>	<input type="checkbox"/>	<input type="checkbox"/>	<input type="checkbox"/>																																																																																																									
	4" Caster & Frog Legs	<input type="checkbox"/>	<input type="checkbox"/>	<input type="checkbox"/> *	<input type="checkbox"/> *	<input type="checkbox"/> *	<input type="checkbox"/> *	<input type="checkbox"/> *	<input type="checkbox"/> *	<input type="checkbox"/>																																																																																																									
	5" Caster & STD Forks	<input type="checkbox"/>	<input type="checkbox"/> *	<input type="checkbox"/> *	<input type="checkbox"/> *	<input type="checkbox"/>	<input type="checkbox"/>	<input type="checkbox"/>	<input type="checkbox"/>	<input type="checkbox"/> *																																																																																																									
	5" Caster & Springs	<input type="checkbox"/>	<input type="checkbox"/>	<input type="checkbox"/>	<input type="checkbox"/> *	<input type="checkbox"/> *	<input type="checkbox"/> *	<input type="checkbox"/> *	<input type="checkbox"/> *	<input type="checkbox"/> *																																																																																																									
5" Caster & Frog Legs	<input type="checkbox"/>	<input type="checkbox"/>	<input type="checkbox"/>	<input type="checkbox"/>	<input type="checkbox"/> *	<input type="checkbox"/> *	<input type="checkbox"/> *	<input type="checkbox"/> *	<input type="checkbox"/> *																																																																																																										
<b>8. REAR SEAT HEIGHT</b>	<input type="checkbox"/> 14.5" <input type="checkbox"/> 15.0" <input type="checkbox"/> 15.5" <input type="checkbox"/> 16.0" <input type="checkbox"/> 16.5" <input type="checkbox"/> 17.0" <input type="checkbox"/> 17.5" <input type="checkbox"/> 18.0" <input type="checkbox"/> 18.5" <input type="checkbox"/> 19.0" .....																																																																																																																		
Rear Seat Height Option <input type="checkbox"/> <b>w/Colours Air Ride System</b>	*The rear seat heights are impacted by the size of your rear tire. Black Color *Includes air pro kit ..... *Including ;Fox Racing Shox 300 HP Pump																																																																																																																		
<input type="checkbox"/> <b>Omit Air Pro Kit \$ -350</b> *For better shock performance	<input type="checkbox"/> Powder-Coated (                      ) (\$380 up charge) <input type="checkbox"/> Polished Aluminum (\$800 up charge)																																																																																																																		
<table border="1" style="width:100%; border-collapse: collapse; text-align: center;"> <thead> <tr><th colspan="2">STD Rear Seat Height Ranges</th></tr> <tr><th>Rear Tire Size</th><th>Rear Seat Height</th></tr> </thead> <tbody> <tr><td>24"x1"(540)</td><td>14.5"- 18.0"</td></tr> <tr><td>24"x1 3/8"(540)</td><td>15.0"- 18.0"</td></tr> <tr><td>25"x1"(559)</td><td>15.5"- 18.0"</td></tr> <tr><td>24"x2"(540)</td><td>15.5"- 18.5"</td></tr> <tr><td>26"x1"(590)</td><td>15.5"- 19.0"</td></tr> <tr><td>25"x1.95"(559)</td><td>16.0"- 19.0"</td></tr> </tbody> </table>	STD Rear Seat Height Ranges		Rear Tire Size	Rear Seat Height	24"x1"(540)	14.5"- 18.0"	24"x1 3/8"(540)	15.0"- 18.0"	25"x1"(559)	15.5"- 18.0"	24"x2"(540)	15.5"- 18.5"	26"x1"(590)	15.5"- 19.0"	25"x1.95"(559)	16.0"- 19.0"	<table border="1" style="width:100%; border-collapse: collapse; text-align: center;"> <thead> <tr><th colspan="2">Rear Seat Height Ranges w/ Air Ride System</th></tr> <tr><th>Rear Tire Size</th><th>Rear Seat Height</th></tr> </thead> <tbody> <tr><td>24"x1"(540)</td><td>16.0"- 18.0"</td></tr> <tr><td>24"x1 3/8"(540)</td><td>16.5"- 18.0"</td></tr> <tr><td>25"x1"(559)</td><td>16.5"- 18.0"</td></tr> <tr><td>24"x2"(540)</td><td>17.0"- 18.5"</td></tr> <tr><td>26"x1"(590)</td><td>17.0"- 19.0"</td></tr> <tr><td>25"x1.95"(559)</td><td>17.5"- 19.0"</td></tr> </tbody> </table>	Rear Seat Height Ranges w/ Air Ride System		Rear Tire Size	Rear Seat Height	24"x1"(540)	16.0"- 18.0"	24"x1 3/8"(540)	16.5"- 18.0"	25"x1"(559)	16.5"- 18.0"	24"x2"(540)	17.0"- 18.5"	26"x1"(590)	17.0"- 19.0"	25"x1.95"(559)	17.5"- 19.0"	<b>REAR SUSPENSION RATING</b> <input type="checkbox"/> Set up 50psi (For 80 lbs-110 lbs weight) <input type="checkbox"/> Set up 60psi (For 110 lbs-140 lbs weight) <input type="checkbox"/> Set up 80psi (For 140 lbs-170 lbs weight) <input type="checkbox"/> Set up 100psi (For 170 lbs-200 lbs weight) <input type="checkbox"/> Set up 120psi (For 200 lbs-230 lbs weight) <input type="checkbox"/> Set up 150psi (For 230 lbs-250 lbs weight)																																																																																	
STD Rear Seat Height Ranges																																																																																																																			
Rear Tire Size	Rear Seat Height																																																																																																																		
24"x1"(540)	14.5"- 18.0"																																																																																																																		
24"x1 3/8"(540)	15.0"- 18.0"																																																																																																																		
25"x1"(559)	15.5"- 18.0"																																																																																																																		
24"x2"(540)	15.5"- 18.5"																																																																																																																		
26"x1"(590)	15.5"- 19.0"																																																																																																																		
25"x1.95"(559)	16.0"- 19.0"																																																																																																																		
Rear Seat Height Ranges w/ Air Ride System																																																																																																																			
Rear Tire Size	Rear Seat Height																																																																																																																		
24"x1"(540)	16.0"- 18.0"																																																																																																																		
24"x1 3/8"(540)	16.5"- 18.0"																																																																																																																		
25"x1"(559)	16.5"- 18.0"																																																																																																																		
24"x2"(540)	17.0"- 18.5"																																																																																																																		
26"x1"(590)	17.0"- 19.0"																																																																																																																		
25"x1.95"(559)	17.5"- 19.0"																																																																																																																		
<b>9. CENTER OF GRAVITY</b>	<input type="checkbox"/> 1.0" <input type="checkbox"/> 1.5" <input type="checkbox"/> 2.0" <input type="checkbox"/> 2.5" <input type="checkbox"/> 3.0" <input type="checkbox"/> 3.5" <input type="checkbox"/> 4.0" <input type="checkbox"/> 4.5" <input type="checkbox"/> 5.0" <input type="checkbox"/> 5.5" .....																																																																																																																		
Center of Gravity Ranges ★Excludes 24" x 2", 26" x 1", 25" x 1.95" tires are selected. ☆=Not available with Air Ride System	<table border="1" style="width:100%; border-collapse: collapse; text-align: center;"> <thead> <tr><th colspan="2" rowspan="2"></th> <th colspan="10">Your Center of Gravity</th> </tr> <tr> <th>1.0"</th><th>1.5"</th><th>2.0"</th><th>2.5"</th><th>3.0"</th><th>3.5"</th><th>4.0"</th><th>4.5"</th><th>5.0"</th><th>5.5"</th> </tr> </thead> <tbody> <tr><td rowspan="6" style="writing-mode: vertical-rl; transform: rotate(180deg);">Your Seat Depth</td><td>14"</td><td><input type="checkbox"/></td><td><input type="checkbox"/>★</td><td><input type="checkbox"/>★</td><td></td><td></td><td></td><td></td><td></td><td></td><td></td></tr> <tr><td>15"</td><td><input type="checkbox"/>★</td><td><input type="checkbox"/>★</td><td><input type="checkbox"/></td><td><input type="checkbox"/>★</td><td><input type="checkbox"/>★</td><td></td><td></td><td></td><td></td><td></td></tr> <tr><td>16"</td><td><input type="checkbox"/>★</td><td><input type="checkbox"/>★</td><td><input type="checkbox"/>★</td><td><input type="checkbox"/></td><td><input type="checkbox"/></td><td><input type="checkbox"/>★</td><td><input type="checkbox"/>★</td><td></td><td></td><td></td></tr> <tr><td>17"</td><td><input type="checkbox"/>★</td><td><input type="checkbox"/>★</td><td><input type="checkbox"/></td><td><input type="checkbox"/></td><td><input type="checkbox"/></td><td><input type="checkbox"/></td><td><input type="checkbox"/></td><td><input type="checkbox"/>★</td><td><input type="checkbox"/>★</td><td></td></tr> <tr><td>18"</td><td><input type="checkbox"/>★</td><td><input type="checkbox"/>★</td><td><input type="checkbox"/></td><td><input type="checkbox"/></td><td><input type="checkbox"/></td><td><input type="checkbox"/></td><td><input type="checkbox"/></td><td><input type="checkbox"/></td><td><input type="checkbox"/></td><td><input type="checkbox"/>★</td></tr> <tr><td>19"</td><td><input type="checkbox"/>★</td><td><input type="checkbox"/>★</td><td><input type="checkbox"/>★</td><td><input type="checkbox"/></td><td><input type="checkbox"/></td><td><input type="checkbox"/></td><td><input type="checkbox"/></td><td><input type="checkbox"/></td><td><input type="checkbox"/></td><td><input type="checkbox"/></td></tr> </tbody> </table>			Your Center of Gravity										1.0"	1.5"	2.0"	2.5"	3.0"	3.5"	4.0"	4.5"	5.0"	5.5"	Your Seat Depth	14"	<input type="checkbox"/>	<input type="checkbox"/> ★	<input type="checkbox"/> ★								15"	<input type="checkbox"/> ★	<input type="checkbox"/> ★	<input type="checkbox"/>	<input type="checkbox"/> ★	<input type="checkbox"/> ★						16"	<input type="checkbox"/> ★	<input type="checkbox"/> ★	<input type="checkbox"/> ★	<input type="checkbox"/>	<input type="checkbox"/>	<input type="checkbox"/> ★	<input type="checkbox"/> ★				17"	<input type="checkbox"/> ★	<input type="checkbox"/> ★	<input type="checkbox"/>	<input type="checkbox"/>	<input type="checkbox"/>	<input type="checkbox"/>	<input type="checkbox"/>	<input type="checkbox"/> ★	<input type="checkbox"/> ★		18"	<input type="checkbox"/> ★	<input type="checkbox"/> ★	<input type="checkbox"/>	<input type="checkbox"/>	<input type="checkbox"/>	<input type="checkbox"/>	<input type="checkbox"/>	<input type="checkbox"/>	<input type="checkbox"/>	<input type="checkbox"/> ★	19"	<input type="checkbox"/> ★	<input type="checkbox"/> ★	<input type="checkbox"/> ★	<input type="checkbox"/>	<input type="checkbox"/>	<input type="checkbox"/>	<input type="checkbox"/>	<input type="checkbox"/>	<input type="checkbox"/>	<input type="checkbox"/>																									
				Your Center of Gravity																																																																																																															
		1.0"	1.5"	2.0"	2.5"	3.0"	3.5"	4.0"	4.5"	5.0"	5.5"																																																																																																								
Your Seat Depth	14"	<input type="checkbox"/>	<input type="checkbox"/> ★	<input type="checkbox"/> ★																																																																																																															
	15"	<input type="checkbox"/> ★	<input type="checkbox"/> ★	<input type="checkbox"/>	<input type="checkbox"/> ★	<input type="checkbox"/> ★																																																																																																													
	16"	<input type="checkbox"/> ★	<input type="checkbox"/> ★	<input type="checkbox"/> ★	<input type="checkbox"/>	<input type="checkbox"/>	<input type="checkbox"/> ★	<input type="checkbox"/> ★																																																																																																											
	17"	<input type="checkbox"/> ★	<input type="checkbox"/> ★	<input type="checkbox"/>	<input type="checkbox"/>	<input type="checkbox"/>	<input type="checkbox"/>	<input type="checkbox"/>	<input type="checkbox"/> ★	<input type="checkbox"/> ★																																																																																																									
	18"	<input type="checkbox"/> ★	<input type="checkbox"/> ★	<input type="checkbox"/>	<input type="checkbox"/>	<input type="checkbox"/>	<input type="checkbox"/>	<input type="checkbox"/>	<input type="checkbox"/>	<input type="checkbox"/>	<input type="checkbox"/> ★																																																																																																								
	19"	<input type="checkbox"/> ★	<input type="checkbox"/> ★	<input type="checkbox"/> ★	<input type="checkbox"/>	<input type="checkbox"/>	<input type="checkbox"/>	<input type="checkbox"/>	<input type="checkbox"/>	<input type="checkbox"/>	<input type="checkbox"/>																																																																																																								
<b>10. CAMBER ANGLE</b>	<input type="checkbox"/> 2° <input type="checkbox"/> 4° .....																																																																																																																		
<b>11. FRONT OF SEAT SLING TO FRONT OF FOOTREST</b>	<input type="checkbox"/> 14.5" <input type="checkbox"/> 15.0" <input type="checkbox"/> 15.5" <input type="checkbox"/> 16.0" <input type="checkbox"/> 16.5" <input type="checkbox"/> 17.0" <input type="checkbox"/> 17.5" <input type="checkbox"/> 18.0" <input type="checkbox"/> 18.5" <input type="checkbox"/> 19.0" ..																																																																																																																		
<b>HIGH MOUNT</b> With Risers or Clamps	<input type="checkbox"/> 9.5" <input type="checkbox"/> 10.0" <input type="checkbox"/> 10.5" <input type="checkbox"/> 11.0" <input type="checkbox"/> 11.5" <input type="checkbox"/> 12.0" <input type="checkbox"/> 12.5" <input type="checkbox"/> 13.0" <input type="checkbox"/> 13.5" <input type="checkbox"/> 14.0" .....																																																																																																																		
<b>12. INSIDE WHEEL CLEARANCE</b>	<input type="checkbox"/> 3/4" * <input type="checkbox"/> 1" <input type="checkbox"/> 1 1/4" <input type="checkbox"/> 1 1/2" <input type="checkbox"/> 1 3/4" <input type="checkbox"/> 2"																																																																																																																		
	*3/4" Inside wheel clearance not available with 2 degree camber. (with the exception of Y-360 wheels) *3/4" Inside wheel clearance not available with armrest																																																																																																																		

## 1. SEAT WIDTH

Measure from outside of seat tube to the outside of the opposite seat tube.

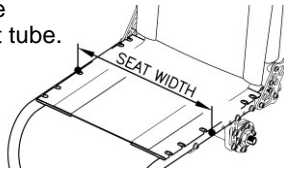

## 2. SEAT DEPTH

Measure from at the front bottom of backrest tube to the front edge of seat sling.

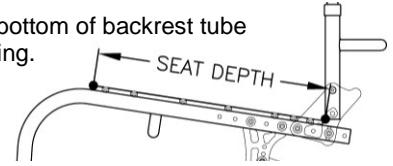

## 3. FOOTREST WIDTH

Measure from inside of front frame tube to inside of opposite front frame tube.

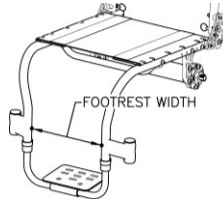

## 4. FRAME ANGLE

Measure angle frame front to floor.

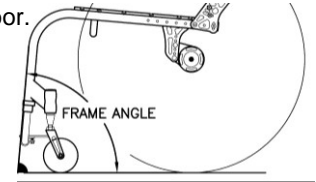

## 5. BACKREST HEIGHT

Measure from top of back post to seat sling at front bottom of backrest tube.

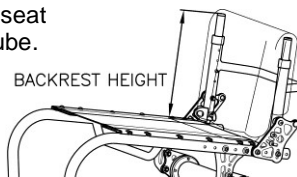

## 6. BACKREST ANGLE

Measure angle from front of back post to floor.

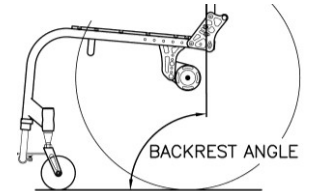

## 7. FRONT SEAT HEIGHT

Measure from floor to top of seat sling at front edge.

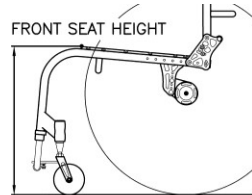

## 8. REAR SEAT HEIGHT

Measure from floor to top of seat sling at front bottom of backrest tube.

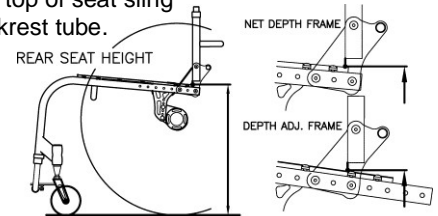

## 9. CENTER OF GRAVITY

Measure from center of back tube at the folding pivot to the center of the rear axle.

( If welding backrest is selected, Measure from center of back tube at the seat tube to the center of the rear axle. )

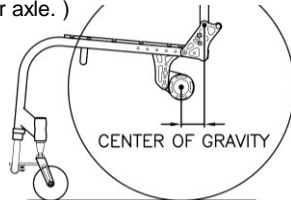

## 10. CAMBER ANGLE

Measure angle from wheel to vertical at floor.

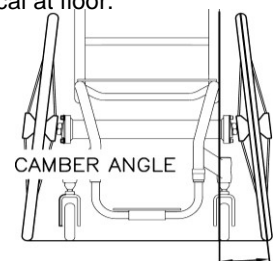

## 11. FRONT OF SEAT SLING TO FOOTREST

### ADULT CHAIR

Measure from top of seat sling at front edge to top of foot plate at front edge.

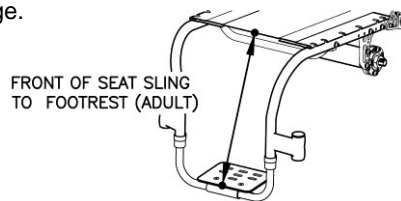

### PEDIATRIC CHAIR

Measure vertical from top of seat sling at front edge to top of foot plate.

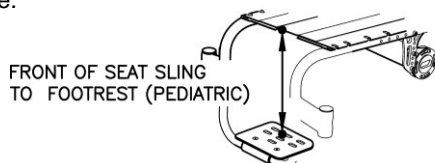

## 12. INSIDE WHEEL CLEARANCE

Measure from outside of seat back tube to inside of rear tire.

( If side guards are selected, measure from outside of side guards to inside of rear tire.)

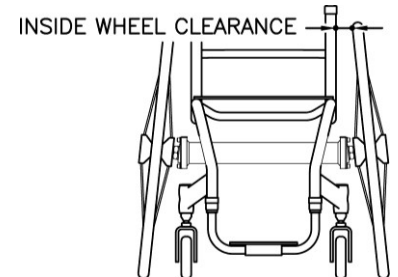

**C SPECIAL PARTS COLORS ( Please allow an additional 1-2 weeks delivery)**

PARTS COLORS						
<b>Powder-Coated</b>	Gloss Black	Twilight Flake	Yellow	Magenta	Fire Engine Red	White
Neon Yellow	Candy Blue	Candy Purple	Candy Green	Candy Red	Candy Raspberry	Cobalt Blue
Brass Metallic	Matte Gray	Matte Purple	Matte Blue	Matte Green	Matte Black	Matte Red
Sparkle Burgundy	Neon Red	Neon Green	Orange Sparkle	Mellon Yellow	Gun Smoke Silver	Shocker Yellow
Tiffany Blue		Granny Sparkle Green	Sparkle Sky Blue	Reed Green	Blue Lilac	
<b>Special Colors</b>	Polished Aluminum					
	24 karat Gold Plated *Please allow an additional 4 weeks delivery					

**Please Choose the Color for each Part**  
 \*Parts not selected will be black color. (Suspension Spring: Silver Color)  
 \*Minimum 3 parts selected per order.

\*PC=Powder-Coated

**Saddle Stops**  
 PC ( )  
 Polished  
 Gold Plated

**Footrest Rings**  
 PC ( )  
 Polished  
 Gold Plated

**Footrest Tubes**  
 PC  
 Polished  
 Gold Plated

**Footrest Clamps**  
 PC ( )  
 Polished  
 Gold Plated

**Foot Plate**  
 PC ( )  
 Polished  
 Gold Plated

**Suspension Main Frame**  
 PC ( )  
 Polished  
 Gold Plated

**Upper A-Arms**  
 PC ( )  
 Polished  
 Gold Plated

**Lower A-Arms**  
 PC ( )  
 Polished  
 Gold Plated

**Backrest**  
 PC ( )  
 Polished  
 Gold Plated

**Backrest Brackets**  
 PC ( )  
 Polished  
 Gold Plated

**Caps**  
 PC ( )  
 Polished  
 Gold Plated

**Caster Housing**  
 PC ( )  
 Polished  
 Gold Plated

**Front Springs**  
 PC ( )  
 Polished  
 Gold Plated

**Forks & Knurl Nuts**  
 PC ( )  
 Polished.....  
 Gold Plated.....

**Axle Bases**  
 PC ( )  
 Polished  
 Gold Plated

**Axle Clamps**  
 PC ( )  
 Polished  
 Gold Plated

**Axle Plates**  
 PC ( )  
 Polished  
 Gold Plated

**Camber Plates**  
 PC ( )  
 Polished  
 Gold Plated

**Axle Tube**  
 PC ( )  
 Polished  
 Gold Plated

**Axle Receiver Holder**  
 PC ( )  
 Polished  
 Gold Plated

**D COMPONENTS**

**WHEEL LOCKS**

New Solutions Push to Lock  w/ 2" Extension Handle (\$80 up charge)

Gallop Push to Lock / Anodized

Question Mark Style Scissor

NEW Compact Scissor Lock / Anodized Black Only

Gallop Scissor Lock / Anodized

**PUSH HANDLES** \*If you are ordering push handles, You must select the backrest locking mechanism.

Integrated w/Fixed Backrest Height / Anodized Black Only

Bolt-on / Anodized Black Only Specify Height from floor -( )

Bolt-on w/Quick Release / Anodized Black Only Specify Height from floor -( )

NEW Height Adj. / Anodized Black Only Specify Maximum height from floor -( )

**NEW ARM RESTS** Anodized Black Only

Fixed Tubular Armrest Adj. Angle and Height Height from seat sling Set at : 8" 9" 10" 11" 12" **E0973**

Swing Away Tubular Armrest Adj. Angle and Height Height from seat sling Set at : 8" 9" 10" 11" 12" **E0973**

Flip-Up Armrest  w/Fixed Tubular Armrest Height from seat sling Set at : 8" 9" 10" 11" 12" **E0973**  
Adj. Angle  w/ Swing Away Tubular Armrest Height from seat sling Set at : 8" 9" 10" 11" 12" **E0973**

Custom Length & Height (\$150 up charge)  
\*Specify Height & Length →

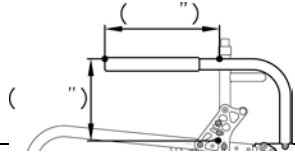

**ANTI-TIPPERS**

Removable Anti-tipper(pair) Anodized Black Only **E0971**

Press Release Removable Anti-tipper(pair) **E0971**

**SIDE GUARDS**

Rigid Side Guards - Black ABS  Non-Removable  Removable  Removable w/Hole (\$12 up charge)  
Color: Black Only | Size:  STD  Medium  Cut to Wheel (\$98 up charge) Measurement

Rigid Side Guards - Aluminum  Non-Removable  Removable

Size:  Medium Only  Cut to Wheel (\$98 up charge) Measurement  
Color  Black (STD)  Pol. Aluminum (STD)  
 Powder Coated ( ) (\$120 up charge)  
 Gold Plate (+CFP)

Height	Size
7.5"	STD
8.25"	Medium

14.5"

8.25"

Front: Above Wheel Rear: Above Wheel

Fabric Clothing Guards Black Nylon w/Velcro

**SEAT CUSHION** -\*Please see section for other cushion choices.-

Foam Cushion w/Nylon Black Cover Thickness 1" 2" 3" 4"

Custom Cushion Cover (Std. Foam Cushion Only) -Select Fabric ( ) (\$90 up charge)

**ACCESSORIES**

Frame Protectors / Black Leather/Zipper Type

Gel Ovation Protector Wraps Gel Silicone

E0978 Seat Belt w/Auto Buckle (BP) 1.5" Black Belt Only **E0978**

Tie Down Brackets 4pcs.

Calf Strap  Black  Matching Fabric (\$55 up charge) -Select Fabric ( )

Bodypoint Padded Calf Strap  (14"-16" footrest width)  (16"-20" footrest width)  (20"-24" footrest width)  
\$77 \$83 \$89

Hanging Zipper Pouch  Black  Matching Fabric (\$60) or  Leather (\$75) Custom Size Width: Length:

Matching Fabric on Padded Side Guards -Select Fabric ( )

**UPHOLSTERY CHOICE & COLOR** \*Positioning Back Available. Please see Section E

Standard Adjustable Height Backrest (Black)

Adjustable Tension Backrest Black Only (\*Not available with 8" Backrest Height)

Options  Fun Fabric: For Std. or Adj. Style  
(Choose From Choices on Page 7 and write below) (\$ 80 up charge)

Backrest Leather Trim (outside panels) (\$ up charge)

FABRIC CHOICE SHEET

1. Camouflage Girls



2. Purple Zebra



3. Silver Grey Snake



5. Laughing Skulls



6. Purple Snake

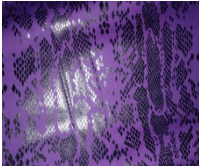

7. Sweetheart Pinup Girls



9. Blue Flames

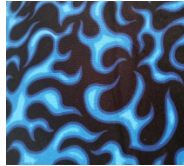

10. Arctic Camo



11. Furry Friends



12. Supercars



13. Urban Camo

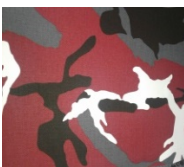

14. Superbikes



15. Sizzle Flames



16. Hot Rod Flames



17. Skulls w/ Attitude

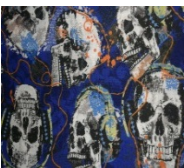

18. Sweet Pink



19. Heart and Soul



20. Home Run



21. Fuzzy Giraffe

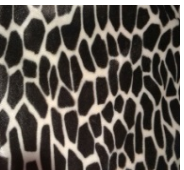

22. Cheetah



23. Paperweight Cobalt



24. Zig Zag Dots



25. Smokey Tribal Flames

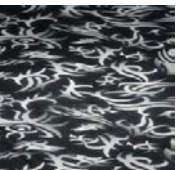

26. Rose and Rebellion



27. Tattoo Adventure(Cream

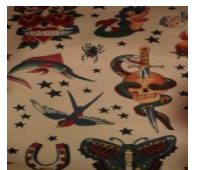

28. Red Tribal Flames

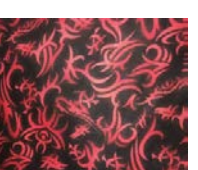

29. Tattoo Adventure(Black)

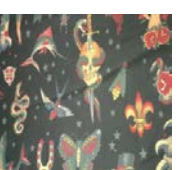

30. Butterfly Bandana

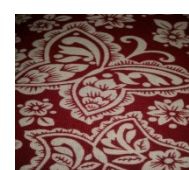

31. Tatsu Dragon

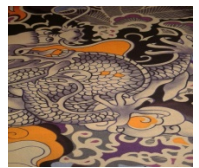

**E TIRES, CASTERS, & FORKS**



<b>TIRES</b>	
<input type="checkbox"/> <b>Primo High Pressure Tire</b> <input type="checkbox"/> 24"x1" <input type="checkbox"/> 25"x1" <input type="checkbox"/> 26"x1" Gray Tire w/ black line	E2211/E2212
<input type="checkbox"/> <b>Primo High Pressure Tire</b> <input type="checkbox"/> 24"x1" <input type="checkbox"/> 25"x1" or <input type="checkbox"/> 26"x1" <input type="checkbox"/> Blue <input type="checkbox"/> Red	E2211/E2212
<input type="checkbox"/> <b>Low Pressure Tire</b> <input type="checkbox"/> 24"x1-3/8" or <input type="checkbox"/> 26"x1-3/8" Gray Only	E2211/E2212
<input type="checkbox"/> <b>Schwalbe Marathon Plus High Pressure Tire</b> <input type="checkbox"/> 24"x1", <input type="checkbox"/> 25"x1" or <input type="checkbox"/> 26"x1" Black Only	E2211/E2212
<input type="checkbox"/> <b>Solid Tire</b> <input type="checkbox"/> 24"x1" <input type="checkbox"/> 25"x1" Black	E2218
<input type="checkbox"/> <b>Solid Tire</b> <input type="checkbox"/> 26"x1" Dark Grey	
<input type="checkbox"/> <b>Moderate V-Track Knobby Tire</b> 24"x1-3/8" (37-540) Gray Only	E2211/E2212
<input type="checkbox"/> <b>Aggressive Knobby Tire</b> 24"x 2" (50-540) Gray Only <input type="checkbox"/> Blue Line <input type="checkbox"/> Red Line	E2211/E2212
<input type="checkbox"/> <b>Aggressive Knobby Tire</b> 26"x 2" (50-559) Gray Only <input type="checkbox"/> Blue Line <input type="checkbox"/> Red Line	E2211/E2212
<input type="checkbox"/> <b>Aggressive Knobby Tire</b> 24" x 1.95"(50-540) Black Only	E2211/E2212
<input type="checkbox"/> <b>E2211 Bell Mountain Bike Tire</b> in Flat Defense (559) 26" X 1.75 - 2.25 Black Only	E2211/E2212
<input type="checkbox"/> <b>Flat-Free Inserts</b> For 24"x1-3/8" Tires Only	E2211/E2213

<b>CASTERS</b>					
SIZE	TIRE WIDTH	HUB COLOR	TIRE COLOR	DESCRIPTION	
<input type="checkbox"/> 3"	1"	Black Hub	Black Tire Only	Polyurethane	K0077
<input type="checkbox"/> 3"	1"	Plastic Black Hub	Clear Tire Only	Lighted, Polyurethane	A9900
<input type="checkbox"/> 3"	1"	Red Hub	Red Tire Only	Polyurethane	E2222
<input type="checkbox"/> 3"	1"	Black Hub	Clear Tire Only	Polyurethane	E2222
<input type="checkbox"/> 3"	1"	Aluminum Silver Hub	Black Tire Only	Made By Frog Legs	K0071
<input type="checkbox"/> 3"	1"	Aluminum Black Hub	Black Tire Only	Made By Frog Legs	E2222
<input type="checkbox"/> 3"	1.5"	Aluminum Silver Hub	Black Tire Only	Soft Roll Made By Frog Legs	E2222
<input type="checkbox"/> 3"	1.5"	Aluminum Black Hub	Black Tire Only	Soft Roll Made By Frog Legs	E2222
<input type="checkbox"/> 4"	1 1/8"	Plastic Black Hub	Black Tire Only	Polyurethane Not Available with Narrow Frog Leg Forks	E2222
<input type="checkbox"/> 4"	1"	Plastic Black Hub	Clear Only	Lighted, Polyurethane	E2221
<input type="checkbox"/> 4"	1"	Aluminum Silver Hub	Black Tire Only	Made By Frog Legs	E2214
<input type="checkbox"/> 4"	1"	Aluminum Black Hub	Black Tire Only	Made By Frog Legs	E2214
<input type="checkbox"/> 4"	1.5"	Aluminum Silver Hub	Tire <input type="checkbox"/> Black <input type="checkbox"/> Blue <input type="checkbox"/> Red	Soft Roll Made By Frog Legs	E1015
<input type="checkbox"/> 4"	1.5"	Aluminum Black Hub	Black Tire Only	Soft Roll Made By Frog Legs	E2214
<input type="checkbox"/> 5"	1"	Composite Black	Black Tire Only	Polyurethane	E2222
<input type="checkbox"/> 5"	1"	Plastic Black Hub	Clear Tire Only	Lighted, Polyurethane	A9900
<input type="checkbox"/> 5"	1"	Aluminum Silver Hub	Black Tire Only	Made By Frog Legs	A9900
<input type="checkbox"/> 5"	1"	Aluminum Black Hub	Black Tire Only	Made By Frog Legs	E2214
<input type="checkbox"/> 5"	1.5"	Aluminum Silver Hub	Tire <input type="checkbox"/> Black <input type="checkbox"/> Blue <input type="checkbox"/> Red	Soft Roll Made By Frog Legs	K0072
<input type="checkbox"/> 5"	1.5"	Aluminum Black Hub	Black Tire Only	Soft Roll Made By Frog Legs	E2222
<input type="checkbox"/> 6"	1.5"	Aluminum Black Hub	Black Tire Only	Soft Roll Made By Frog Legs	E2222
<input type="checkbox"/> 6"	1.5"	Aluminum Silver Hub	Black Tire Only	Soft Roll Made By Frog Legs	E2222
<input type="checkbox"/> "	<input type="checkbox"/> 1"OR <input type="checkbox"/> 1.5"	Hub Color:	Tread Color:	Soft Roll Made By Frog Legs	E2222

<b>FORKS</b>		<input type="checkbox"/> <b>Frog Leg Shields(4 pcs) Only for Frog Leg Forks</b>
<input type="checkbox"/> <b>STD Aluminum Forks</b> Black Only	Extra Options for Aluminum Forks <input type="checkbox"/> With Suspension Springs E1015	
	<input type="checkbox"/> With Quick Release Axles K0073	
<input type="checkbox"/> <b>Frog Leg Suspension Forks 1" Wide</b> (For 3", 4" x 1" width Caster and 5" STD Caster, 5" lighted Caster)	Not available with Quick Release Axle	
*User's Weight _____ Color <input type="checkbox"/> Anodized Black <input type="checkbox"/> Anodized Silver	E1015	
<input type="checkbox"/> <b>Frog Leg Suspension Forks 1.5" Wide</b> (For 3", 4" x 1.5" width Caster and 5" x 1"& 5" x 1.5" Casters )	Not available with Quick Release Axle	
*User's Weight _____ Color <input type="checkbox"/> Anodized Black <input type="checkbox"/> Anodized Silver	E1015	



**F WHEELS**

<b>WHEELS</b>													
<b>Wire Wheels</b>	<input type="checkbox"/> 24" (540) <input type="checkbox"/> 25" (599) ..... <input type="checkbox"/> 26" (590)												
<b>Y-360 Billet Wheels</b> <small>*Max. Capacity 220Lbs *Camber 0-2" max          *Not for Sports or Rugged use</small>	<input type="checkbox"/> 25" (559) ..... Style <input type="checkbox"/> Saw Blade												
<b>Y-360 Billet Wheels MOD Style</b> <small>*Max. Capacity 220Lbs *Camber 0-2" max          *Not for Sports or Rugged use</small>	<input type="checkbox"/> 25" (559) Only Style <input type="checkbox"/> Tribal Sun <input type="checkbox"/> Girls <input type="checkbox"/> Eagle <input type="checkbox"/> Holy Cross <input type="checkbox"/> Hono(Flames) ..... Specify Powder Coat Color for Insert Only ( ) *Choose from Frame Colors												
<b>Extra Options for</b>  <input type="checkbox"/> Powder-Coated Spokes Only ( ) *Choose from Frame Colors <b>(\$250 up charge)</b>													
<b>Spinergy Spox 18 Spokes</b> 	<input type="checkbox"/> 24" (540) <input type="checkbox"/> 25" (559) <input type="checkbox"/> 26" (590) Spoke Color <input type="checkbox"/> Black With Silver Hub <input type="checkbox"/> Red With Black Hub <input type="checkbox"/> Yellow With Black Hub <input type="checkbox"/> Blue With Black Hub <input type="checkbox"/> White With Black Hub .....  <input type="checkbox"/> Custom Color Spoke Pattern <table border="1" style="display: inline-table; margin-left: 10px;"> <tr> <td></td> <td>Left Wheel</td> <td>Right Wheel</td> </tr> <tr> <td>Spokes</td> <td>Inside</td> <td>.....</td> </tr> <tr> <td>Color</td> <td>Outside</td> <td></td> </tr> <tr> <td>Hub Color</td> <td><input type="checkbox"/> Black/<input type="checkbox"/> Silver</td> <td><input type="checkbox"/> Black/<input type="checkbox"/> Silver</td> </tr> </table>		Left Wheel	Right Wheel	Spokes	Inside	.....	Color	Outside		Hub Color	<input type="checkbox"/> Black/ <input type="checkbox"/> Silver	<input type="checkbox"/> Black/ <input type="checkbox"/> Silver
	Left Wheel	Right Wheel											
Spokes	Inside	.....											
Color	Outside												
Hub Color	<input type="checkbox"/> Black/ <input type="checkbox"/> Silver	<input type="checkbox"/> Black/ <input type="checkbox"/> Silver											
<b>Spinergy LX 12 Spokes</b> 	<input type="checkbox"/> 24" (540) <input type="checkbox"/> 25" (559) <input type="checkbox"/> 26" (590) Spoke Color <input type="checkbox"/> Black With Silver Hub <input type="checkbox"/> Red With Black Hub <input type="checkbox"/> Yellow With Black Hub <input type="checkbox"/> Blue With Black Hub <input type="checkbox"/> White With Black Hub <input type="checkbox"/> Neon Green With Black Hub <input type="checkbox"/> Pink With Black Hub <input type="checkbox"/> Orange With Black Hub <input type="checkbox"/> Purple With Black Hub  <input type="checkbox"/> Custom Color Spoke Pattern <table border="1" style="display: inline-table; margin-left: 10px;"> <tr> <td></td> <td>Left Wheel</td> <td>Right Wheel</td> </tr> <tr> <td>Spokes</td> <td>Inside</td> <td></td> </tr> <tr> <td>Color</td> <td>Outside</td> <td></td> </tr> <tr> <td>Hub Color</td> <td><input type="checkbox"/> Black/<input type="checkbox"/> Silver</td> <td><input type="checkbox"/> Black/<input type="checkbox"/> Silver</td> </tr> </table>		Left Wheel	Right Wheel	Spokes	Inside		Color	Outside		Hub Color	<input type="checkbox"/> Black/ <input type="checkbox"/> Silver	<input type="checkbox"/> Black/ <input type="checkbox"/> Silver
	Left Wheel	Right Wheel											
Spokes	Inside												
Color	Outside												
Hub Color	<input type="checkbox"/> Black/ <input type="checkbox"/> Silver	<input type="checkbox"/> Black/ <input type="checkbox"/> Silver											
<b>Spinergy X-Laced Sport Lite Extreme "XSLX" 24 Spokes</b> 	<input type="checkbox"/> 24" (540) <input type="checkbox"/> 25" (559) <input type="checkbox"/> 26" (590) Spoke Color <input type="checkbox"/> Black With Silver Hub <input type="checkbox"/> Red With Black Hub <input type="checkbox"/> Yellow With Black Hub <input type="checkbox"/> Blue With Black Hub <input type="checkbox"/> White With Black Hub <input type="checkbox"/> Neon Green With Black Hub <input type="checkbox"/> Pink With Black Hub <input type="checkbox"/> Orange With Black Hub <input type="checkbox"/> Purple With Black Hub  <input type="checkbox"/> Custom Color Spoke Pattern <table border="1" style="display: inline-table; margin-left: 10px;"> <tr> <td></td> <td>Left Wheel</td> <td>Right Wheel</td> </tr> <tr> <td>Spokes</td> <td>Inside</td> <td></td> </tr> <tr> <td>Color</td> <td>Outside</td> <td></td> </tr> <tr> <td>Hub Color</td> <td><input type="checkbox"/> Black/<input type="checkbox"/> Silver</td> <td><input type="checkbox"/> Black/<input type="checkbox"/> Silver</td> </tr> </table>		Left Wheel	Right Wheel	Spokes	Inside		Color	Outside		Hub Color	<input type="checkbox"/> Black/ <input type="checkbox"/> Silver	<input type="checkbox"/> Black/ <input type="checkbox"/> Silver
	Left Wheel	Right Wheel											
Spokes	Inside												
Color	Outside												
Hub Color	<input type="checkbox"/> Black/ <input type="checkbox"/> Silver	<input type="checkbox"/> Black/ <input type="checkbox"/> Silver											

Valid from 2022 Prices & Specifications Are Subject To Change Without Notice.

**Spinergy Sport Lite Extreme "SLX" 24 Spoke**



24" (540)    25" (559)    26" (590)

Spoke Color    Black    Red    Yellow    Blue  
                     With Silver Hub   With Black Hub   With Black Hub   With Black Hub  
 White    Neon Green    Pink    Orange    Purple  
                     With Black Hub   With Black Hub   With Black Hub   With Black Hub   With Black Hub

Custom Color Spoke Pattern

		Left Wheel	Right Wheel
Spokes	Inside		
	Outside		
Hub Color		<input type="checkbox"/> Black/ <input type="checkbox"/> Silver	<input type="checkbox"/> Black/ <input type="checkbox"/> Silver

**Spinergy Lite Extreme "XLX" X-Laced-12 Spoke**



24" (540)    25" (559)    26" (590)

Spoke Color    Black    Red    Yellow    Blue  
                     With Silver Hub   With Black Hub   With Black Hub   With Black Hub  
 White    Neon Green    Pink    Orange    Purple  
                     With Black Hub   With Black Hub   With Black Hub   With Black Hub   With Black Hub

Custom Color Spoke Pattern

		Left Wheel	Right Wheel
Spokes	Inside		
	Outside		
Hub Color		<input type="checkbox"/> Black/ <input type="checkbox"/> Silver	<input type="checkbox"/> Black/ <input type="checkbox"/> Silver

**Spinergy Blade "LXL" 18 Spoke**



24" (540)    25" (559)    26" (590)

Spoke Color    Black    Red    Yellow    Blue  
                     With Silver Hub   With Black Hub   With Black Hub   With Black Hub  
 White    Neon Green    Pink    Orange    Purple  
                     With Black Hub   With Black Hub   With Black Hub   With Black Hub   With Black Hub

Custom Color Spoke Pattern

		Left Wheel	Right Wheel
Spokes	Inside		
	Outside		
Hub Color		<input type="checkbox"/> Black	<input type="checkbox"/> Black

**HANDRIM**

**Type**

Standard For 24", 25" or 26" Wheel Anodized Black

Vinyl Coated For 24", 25" & 26" Wheels      Not available with Y-360 Billet Wheels \* \* \* \* \*

Spinergy Silver Brushed Anodized For 24", 25" & 26"      Not available with Y-360 Billet Wheels \* \* \* \* \*

Natural Fit For 24", 25" & 26" Wheel

- Standard Grip (Not available with short tabs.) Not available with Y-360 Billet Wheels \* \* \* \* \*
- Super Grip (Not available with short tabs.) Not available with Y-360 Billet Wheels \* \* \*
- Without Thumb Grip (Not available with Y-360 Billet Wheels) \* \* \* \* \*

Natural Fit(LT) For 24", 25" & 26" Wheel

- Standard Grip (Not available with short tabs.) Not available with Y-360 Billet Wheels \* \* \* \* \*
- Super Grip (Not available with short tabs.) Not available with Y-360 Billet Wheels \* \* \* \* \*
- Without Thumb Grip (Not available with Y-360 Billet Wheels) \* \* \* \* \*

The Surge Handrims \* Not available with Y-360 Billet Wheels \* \* \* \* \*

The Surge Handrims (LT) \* Not available with Y-360 Billet Wheels \* \* \* \* \*

Spinergy Flex Rim Available only on Spinergy LX & XLX

The Q-Grip Handrims : anti-slip, latex-free, neoprene coating  
 \* Not available with Y-360 Billet Wheels

OMIT HANDRIMS

**TAB LENGTH**

Long Tab ( STD inside clearance 3/4") Not available with Y-360 Billet Wheels \* \* \* \* \*

Short Tab (Inside clearance 1/2") \* Not available with Natural Fit Handrim with thumb grip \* \* \* \* \*

Short Tab (Set closest to wheel cut off excess) \* Not available with Y-360 wheel \* \* \* \* \*

**G CHAIR OPTIONS 1 / 3**

SEAT CUSHION	
<b>SUPRACOR® WHEELCHAIR CUSHIONS</b>	
<b>Stimulite® Contoured Cushion</b> *Black Upholstery only *Comes with Zipper Pouch <input type="checkbox"/> Extra Sensitive (\$35 up charge) <input type="checkbox"/> Sling Style Bottom (\$52 up charge) <input type="checkbox"/> Custom Size ( \$- CFP ) W(    ) x D(    ) <input type="checkbox"/> Extra Cover (\$104 up charge)	<input type="checkbox"/> W14"xD16" (CD1416) . . . . . E2603 <input type="checkbox"/> W16"xD16" (CD1616) . . . . . E2603 <input type="checkbox"/> W16"xD18" (CD1618) . . . . . E2603 <input type="checkbox"/> W18"xD16" (CD1816) . . . . . E2603 <input type="checkbox"/> W18"xD18" (CD1818) . . . . . E2603 <input type="checkbox"/> W18"xD20" (CD1820) . . . . . E2603 <input type="checkbox"/> W20"xD16" (CD2016) . . . . . E2603 <input type="checkbox"/> W20"xD18" (CD2018) . . . . . E2603 <input type="checkbox"/> W20"xD20" (CD2020) . . . . . E2603
<b>Stimulite® Slimline Cushion</b> *Black Upholstery only <input type="checkbox"/> Extra Sensitive (\$35 up charge) <input type="checkbox"/> Sling Style Bottom (\$52 up charge) <input type="checkbox"/> Custom Size ( \$- CFP ) W(    ) x D(    ) <input type="checkbox"/> Extra Cover (\$75 up charge)	<input type="checkbox"/> W14"xD16" (SM1416) . . . . . E2603 <input type="checkbox"/> W16"xD16" (SM1616) . . . . . E2603 <input type="checkbox"/> W16"xD18" (SM1618) . . . . . E2603 <input type="checkbox"/> W18"xD18" (SM1818) . . . . . E2603 <input type="checkbox"/> W18"xD20" (SM1820) . . . . . E2603 <input type="checkbox"/> W20"xD16" (SM2016) . . . . . E2603 <input type="checkbox"/> W20"xD18" (SM2018) . . . . . E2603 <input type="checkbox"/> W20"xD20" (SM2020) . . . . . E2603
<b>Stimulite® Corbee Pediatric</b> *Black Upholstery only <input type="checkbox"/> Extra Cover (\$75 up charge)	<input type="checkbox"/> W10"xD10" (PD1010) . . . . . E2603 <input type="checkbox"/> W12"xD12" (PD1212) . . . . . E2603 <input type="checkbox"/> W14"xD14" (PD1414) . . . . . E2603  <input type="checkbox"/> Extra Sensitive (\$35 up charge) <input type="checkbox"/> Sling Style Bottom (\$52 up charge) <input type="checkbox"/> Custom Size W(    ) x D(    ) ( \$- CFP )
<b>ROHO WHEELCHAIR CUSHIONS</b>	
<input type="checkbox"/> <b>4" HIGH PROFILE® QUADTRO SELECT® CUSHION</b> *Black Upholstery . . . . . <input type="checkbox"/> Extra Cover (\$+57) . . . . . only. E2622-2623	
Choose Size	<input type="checkbox"/> W12"xD12" <input type="checkbox"/> W12"xD13" <input type="checkbox"/> W13"xD13" <input type="checkbox"/> W13"xD15" <input type="checkbox"/> W13"xD16" <input type="checkbox"/> W15"xD13" <input type="checkbox"/> W15"xD15" <input type="checkbox"/> W15"xD16" <input type="checkbox"/> W15"xD18" <input type="checkbox"/> W16"xD15" <input type="checkbox"/> W16"xD16" <input type="checkbox"/> W16"xD18" <input type="checkbox"/> W16"xD20" <input type="checkbox"/> W18"xD15" <input type="checkbox"/> W18"xD16" <input type="checkbox"/> W18"xD18" <input type="checkbox"/> W18"xD20" <input type="checkbox"/> W18"xD22" <input type="checkbox"/> W20"xD16" <input type="checkbox"/> W20"xD18" <input type="checkbox"/> W20"xD20" <input type="checkbox"/> W20"xD22" <input type="checkbox"/> W22"xD18" <input type="checkbox"/> W22"xD20" <input type="checkbox"/> W22"xD22" <input type="checkbox"/> Custom Size W(    ) x D(    ) ( \$+CFP )
Choose Size	<input type="checkbox"/> <b>3" MID PROFILE® QUADTRO SELECT® CUSHION</b> *Black Upholstery only . . . . . <input type="checkbox"/> Extra Cover E2622-2623 <input type="checkbox"/> W15"xD15" <input type="checkbox"/> W15"xD16" <input type="checkbox"/> W16"xD16" <input type="checkbox"/> W16"xD18" <input type="checkbox"/> W18"xD16" <input type="checkbox"/> W18"xD18" <input type="checkbox"/> Custom Size W(    ) x D(    ) ( \$+CFP )
Choose Size	<input type="checkbox"/> <b>2" LOW PROFILE® QUADTRO SELECT® CUSHION</b> *Black Upholstery only . . . . . <input type="checkbox"/> Extra Cover (\$+57) . . . . . E2622-2623 <input type="checkbox"/> W12"xD12" <input type="checkbox"/> W12"xD13" <input type="checkbox"/> W13"xD13" <input type="checkbox"/> W13"xD15" <input type="checkbox"/> W13"xD16" <input type="checkbox"/> W15"xD13" <input type="checkbox"/> W15"xD15" <input type="checkbox"/> W15"xD16" <input type="checkbox"/> W15"xD18" <input type="checkbox"/> W16"xD15" <input type="checkbox"/> W16"xD16" <input type="checkbox"/> W16"xD18" <input type="checkbox"/> W16"xD20" <input type="checkbox"/> W18"xD15" <input type="checkbox"/> W18"xD16" <input type="checkbox"/> W18"xD18" <input type="checkbox"/> W18"xD20" <input type="checkbox"/> W20"xD16" <input type="checkbox"/> W20"xD18" <input type="checkbox"/> W20"xD20" <input type="checkbox"/> Custom Size W(    ) x D(    ) ( \$+CFP )
<b>STAR CUSHIONS</b>	
<b>Galaxy Cushion</b> *Black Upholstery only <input type="checkbox"/> W14"xD14" ( GXY 1414-2) <input type="checkbox"/> W14"xD16" ( GXY 1416-2) <input type="checkbox"/> W16"xD14" ( GXY 1614-2) <input type="checkbox"/> W16"xD16" ( GXY 1616-2) <input type="checkbox"/> W16"xD18" ( GXY 1618-2) <input type="checkbox"/> W18"xD16" ( GXY 1816-2) <input type="checkbox"/> W18"xD18" ( GXY 1818-2) <input type="checkbox"/> W18"xD20" ( GXY 1820-2) <input type="checkbox"/> W20"xD16" ( GXY 2016-2) <input type="checkbox"/> W20"xD18" ( GXY 2018-2) <input type="checkbox"/> W20"xD20" ( GXY 2020-2)	Choose Zoning Options E2624 <input type="checkbox"/> Standard - Dual Valve <input type="checkbox"/> Dual Valve - Front to Back <input type="checkbox"/> Four Valve <input type="checkbox"/> Simple - Single Valve <input type="checkbox"/> Four Valve - Enhanced <input type="checkbox"/> Four Valve - Front to Back
<b>THE CURVE CUSHION</b> *Black Upholstery only <input type="checkbox"/> Extra Cover ( \$+ 40	<input type="checkbox"/> W10"xD10" <input type="checkbox"/> W10"xD11" <input type="checkbox"/> W10"xD11" <input type="checkbox"/> W10"xD12" <input type="checkbox"/> W11"xD12" <input type="checkbox"/> W12"xD12" <input type="checkbox"/> W12"xD13" <input type="checkbox"/> W12"xD14" <input type="checkbox"/> W13"xD11" <input type="checkbox"/> W13"xD12" <input type="checkbox"/> W13"xD13" <input type="checkbox"/> W13"xD14" <input type="checkbox"/> W14"xD14" <input type="checkbox"/> W14"xD15" <input type="checkbox"/> W14"xD16" <input type="checkbox"/> W15"xD14" <input type="checkbox"/> W15"xD15" <input type="checkbox"/> W15"xD16" <input type="checkbox"/> W16"xD14" <input type="checkbox"/> W16"xD15" <input type="checkbox"/> W16"xD16" <input type="checkbox"/> W16"xD17" <input type="checkbox"/> W16"xD18" <input type="checkbox"/> W17"xD16" <input type="checkbox"/> W17"xD17" <input type="checkbox"/> W17"xD18" <input type="checkbox"/> W18"xD16" <input type="checkbox"/> W18"xD17" <input type="checkbox"/> W18"xD18"

Valid from 2022 Prices & Specifications Are Subject To Change Without

**G CHAIR OPTIONS 2 / 3**

SEAT CUSHION	
<b>Exgel Kaji Cushion</b>	
<b>For Comfortable Sitting To Prevent Pressure Sores</b> <input type="checkbox"/> <b>Owl Regular(1.6" Thick)</b> Incontinence Cover Only	<input type="checkbox"/> W14"xD16" ..... E2603 <input type="checkbox"/> W15"xD16" ..... E2603 <input type="checkbox"/> W16"xD16" ..... E2603 <input type="checkbox"/> W18"xD16" ..... * No Custom Sizes E2603
<input type="checkbox"/> <b>Owl High(3.1" Thick)</b> Incontinence Cover Only	<input type="checkbox"/> W14"xD16" ..... E2603 <input type="checkbox"/> W15"xD16" ..... E2603 <input type="checkbox"/> W16"xD16" ..... E2603 <input type="checkbox"/> W18"xD16" ..... E2603 <input type="checkbox"/> W18"xD18" ..... * No Custom Sizes E2603
<input type="checkbox"/> <b>Owl Contour(4.3" Thick)</b> Incontinence Cover Only	<input type="checkbox"/> W14"xD16" ..... E2603 <input type="checkbox"/> W15"xD16" ..... E2603 <input type="checkbox"/> W16"xD16" ..... E2603 <input type="checkbox"/> W18"xD16" ..... E2603 * No Custom Sizes
<input type="checkbox"/> <b>Owl Deep Contour(4.3" Thick)</b> <input type="checkbox"/> W14"xD16" \$ 458    * No Custom Sizes- Incontinence Cover Only <input type="checkbox"/> W14"xD16" \$518 <input type="checkbox"/> W15"xD16" \$518 <input type="checkbox"/> W16"xD16" \$518 <input type="checkbox"/> W18"xD16" \$558	
<input type="checkbox"/> <b>Standard Regular(1.4" Thick)</b> Easy to Use Flat Style (superior pressure redistribution)    * For Pressure    E2622-2623 <input type="checkbox"/> W12" x D12" \$368 <input type="checkbox"/> W13" x D13" \$368 <input type="checkbox"/> W14" x D14" \$368 <input type="checkbox"/> W14" x D16" \$368 <input type="checkbox"/> W16" x D16" \$368 <input type="checkbox"/> W16" x D17" \$368 <input type="checkbox"/> W17" x D16" \$368 <input type="checkbox"/> W17" x D17" \$368 <input type="checkbox"/> W18" x D16" \$391 <input type="checkbox"/> W18" x D18" \$391 <input type="checkbox"/> W18" x D19" \$440 <input type="checkbox"/> W18" x D20" \$440 <input type="checkbox"/> W19" x D19" \$440 * No Custom Sizes- Incontinence Cover Only	
<input type="checkbox"/> <b>Standard High(2.6" Thick)</b> Incontinence Cover Only    ..... E2622 *Black Upholstery only <input type="checkbox"/> W12" x D12" \$383 <input type="checkbox"/> W13" x D13" \$ 383 <input type="checkbox"/> W14" x D14" \$383 <input type="checkbox"/> W14" x D16" \$ 383 <input type="checkbox"/> W16" x D16" \$383 <input type="checkbox"/> W16" x D17" \$383 <input type="checkbox"/> W17" x D16" \$383 <input type="checkbox"/> W17" x D17" \$383 <input type="checkbox"/> W18" x D16" \$460 <input type="checkbox"/> W18" x D18" \$460 <input type="checkbox"/> W18" x D19" \$512 <input type="checkbox"/> W18" x D20" \$512 <input type="checkbox"/> W19" x D19" \$512 <input type="checkbox"/> W18" x D19" \$512	
<input type="checkbox"/> <b>Standard Anti-Thrust(2.6" Thick)</b> * No Custom Sizes Incontinence Cover Only	<input type="checkbox"/> W16 x D16 \$460    Prevents Unwanted <input type="checkbox"/> W18 x D16 \$500    Forward Movement of <input type="checkbox"/> W18 x D18 \$500    lower back and hip bone
<input type="checkbox"/> <b>Lite Regular(2.2" Thick)</b> <input type="checkbox"/> W16" x D16" \$374 <input type="checkbox"/> W18" x D16" \$397 <input type="checkbox"/> W18" x D18" \$397    * No Custom Sizes- Incontinence Cover Only	
<input type="checkbox"/> <b>Lite High(3.0" Thick)</b> <input type="checkbox"/> W16" x D16" \$408 <input type="checkbox"/> W18" x D16" \$431 <input type="checkbox"/> W18" x D18" \$431    * No Custom Sizes- Incontinence Cover Only	

**H CHAIR OPTIONS 3 / 3**

**POSITIONING BACK**

**\*Note : Actual height of the backrest will increase 2" or more.**

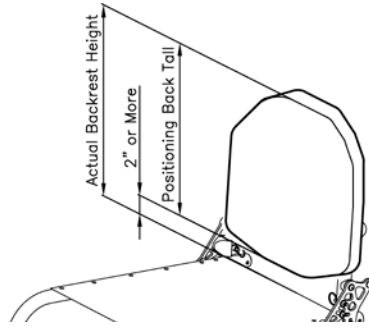

**ADI CARBON BACKREST (Support Contour-ACTIVE 2.5")** \*Not Available with Welded Side Guards

Mounting Hardware:  2 Point Pro  Quick Release

Height	<input type="checkbox"/> LOW (10" Tall) *Backrest Height requires 12" or more *Available 13"-19" width	Width ( " )	E2613
	<input type="checkbox"/> Medium (13" Tall) *Backrest Height requires 15" or more *Available 13"-19" width	Width ( " )	E2613
	<input type="checkbox"/> Standard (16" Tall) *Backrest Height requires 18" or more *Available 13"-19" width	Width ( " )	E2613
	<input type="checkbox"/> Custom Size ( " Tall) x ( " width) . . . . .		E2613

Add Privacy Flap (\$69 up charge)

**ADI ALUMINUM BACKREST (Support Contour-ACTIVE 2.5")** \*Not Available with Welded Side Guards

Mounting Hardware:  2 Point Pro  Quick Release

Height	<input type="checkbox"/> LOW (10" Tall) *Backrest Height requires 12" or more *Available 10"-20" width	Width ( " )	E2613
	<input type="checkbox"/> Medium (13" Tall) *Backrest Height requires 15" or more *Available 12"-20" width	Width ( " )	E2613
	<input type="checkbox"/> Standard (16" Tall) *Backrest Height requires 18" or more *Available 14"-20" width	Width ( " )	E2613
	<input type="checkbox"/> Tall (18" Tall) *Backrest Height requires 20" or more *Available 16"-20" width	Width ( " )	E2613
	<input type="checkbox"/> X-Tall (20" Tall) *Backrest Height requires 22" or more *Available 16"-20" width	Width ( " )	E2613

Add Privacy Flap (\$69 up charge)

Custom Size ( " Tall) x ( " width) . . . . . E2613

**ADI ALUMINUM BACKREST (Support Contour-DEEP 4")** \*Not Available with Welded Side Guards\*Not Available with Lateral Supports

Mounting Hardware:  2 Point Pro  Quick Release

Height	<input type="checkbox"/> LOW (10" Tall) *Backrest Height requires 12" or more *Available 10"-20" width	Width ( " )	E2615
	<input type="checkbox"/> Medium (13" Tall) *Backrest Height requires 15" or more *Available 12"-20" width	Width ( " )	E2615
	<input type="checkbox"/> Standard (16" Tall) *Backrest Height requires 18" or more *Available 14"-20" width	Width ( " )	E2615
	<input type="checkbox"/> Tall (18" Tall) *Backrest Height requires 20" or more *Available 16"-20" width	Width ( " )	E2615
	<input type="checkbox"/> X-Tall (20" Tall) *Backrest Height requires 22" or more *Available 16"-20" width	Width ( " )	E2615

Add Privacy Flap (\$69 up charge)

Custom Size ( " Tall) x ( " width) . . . . . E2615

**ADI LATERAL SUPPORTS ( Lateral Supports are compatible with only active 2.5" ADI positioning back. )**

<input type="checkbox"/> Stationary Pad	Pad Size <input type="checkbox"/> Small (3" H x 3" D) <input type="checkbox"/> Medium(3" H x 4" D) <input type="checkbox"/> Large(4.5" H x 4.5" D) <input type="checkbox"/> Large(4" H x 6" D)
	<input type="checkbox"/> Pair . . . . .
	<input type="checkbox"/> Left side only or <input type="checkbox"/> Right side only . . . . .
<input type="checkbox"/> Swing-Out	Pad Size <input type="checkbox"/> Small (3" H x 3" D) <input type="checkbox"/> Medium(3" H x 4" D) <input type="checkbox"/> Large(4.5" H x 4.5" D) <input type="checkbox"/> Large(4" H x 6" D)
	<input type="checkbox"/> Pair . . . . .
	<input type="checkbox"/> Left side only or <input type="checkbox"/> Right side only

**OTHER**

- ADI Transfer Board  21" (ADV21)  24" (ADV24)  29" . . . . . (ADV29).
- ADI Push and Transfer Gloves **Leather** (one size fits) . . . . .
- ADI Carbon Solid Seat (Wide: 18" Max, Depth: 20" ) ✘ ONLY AVAILABLE WITH COLOURS NON-REMOVABLE SIDE GUARDS

**VARILITE® Seating Systems Available** Please visit for all options. [www.varilite.co](http://www.varilite.co)

NOTE