

Important! This quick reference guide does not replace the user manual

Components

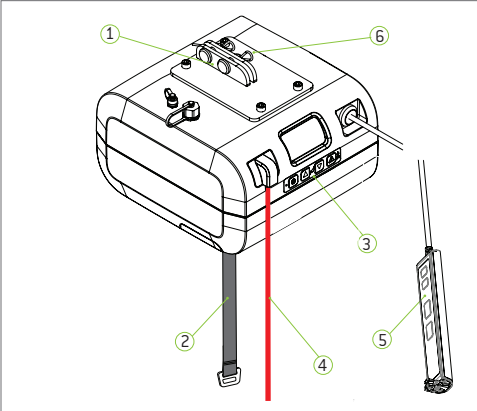

- 1 Connector for Rail Roller
- 2 Lift Belt
- 3 Secondary Panel
- 4 Emergency Stop Belt
- 5 Hand Control (IPX7)
- 6 Mounting Pins

Secondary Panel Functions

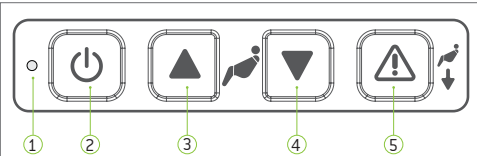

- 1 Status Indicator Light
- 2 Power On/Off
- 3 Raise Lift
- 4 Lower Lift
- 5 Emergency Lowering

Status Indicator Lights

- **Flashing Green**
On/Ready for Use
Full Battery
- **Constant Red**
Safety Catch Engaged
Troubleshooting!
- **Flashing Yellow**
On/Ready for Use
Battery Level Normal
- **Constant Yellow**
Lift Charging
Functions Blocked
- **Flashing Red**
On/Ready for Use
Low Battery
Charge Battery Warning
- **Flashing Green/Yellow**
Service Warning
Perform Inspection
- **Constant Green**
Lift in Use
- **Flashing Red/Yellow**
Service Passed
Battery Low

Important! This overhead lift has been designed and tested for indoor use with one patient at a time. This product must not be immersed in water.
Read all instructions for full product information!

Hand Control Functions

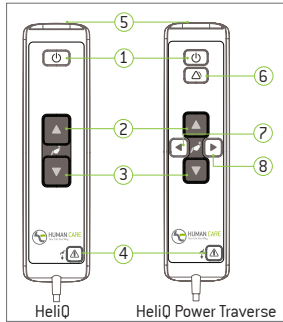

- 1 Off/On Button
 - 2 Up Button
 - 3 Down Button
 - 4 Emergency Lowering
 - 5 USB-C and Charge Port
 - 6 Alarm Button
 - 7 Lift backwards
 - 8 Lift forwards
- For Power Traverse only:

Charging the Lift

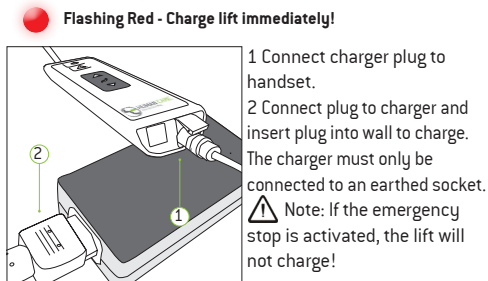

Important! The lift can only be used with a Human Care charger and must be disconnected to use the lift.

Models: 55100H, 55110H, 55120H
(PT) 55130H, 55140H, 55150H
Human Care HC AB. All Rights Reserved.



Using the lift

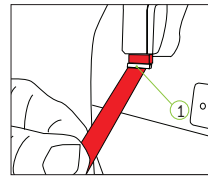

Emergency Stop Activation
Pull red belt to activate.

Emergency De-Activation
Push up activation button (1) located at top of emergency stop belt.

Important! Emergency lowering must only be used in emergency situations. There will be a 3 second delay.

- 1 **Using Hand Control:** Press down button (3) and secondary panel emergency lowering button (5) at the same time.
- 2 **Secondary Panel:** Press down button (4) and emergency lowering (5) at the same time.

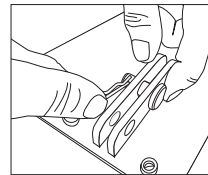

Suspending the lift
The lift is mounted directly to the rail roller which is located in the rail. **Do not use any distance straps.** Remove lock pins holding bolts in place. Remove bolts and line up holes in rail

with holes in rail roller. Replace bolts through holes and secure in place with pins. To detach, reverse process.

Important! The belt must remain taut while being fed into the lift.

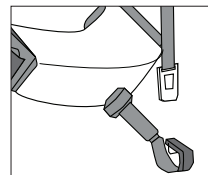

Hanger bar
Lower the lift strap to a comfortable working height. Connect hanger bar to lift by hooking hanger bar diagonally from beneath the lift strap.

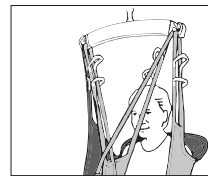

Slings
Use hand control to position hanger bar directly above patient. Attach head sling loops to carry bar first, then leg straps.

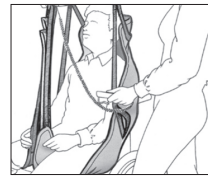

Proper lifting techniques
Do not use the hanger bar to move the patient and the lift. Do not hold onto the hooks while performing a lift. Once the patient is comfortably secured in sling, raise lift, hold sling and position/move patient.

General Care

- Charge lift every night.
- Wipe down with slightly dampened drying cloth.
- Disinfect with DuPont™ Virkon®.
- Never use strong detergents on lift.
- Do not immerse in water.
- Activate emergency stop when not in use.

Important! Do not use strap to transport!
If lift is removed from ceiling mount, it must always be stored or moved in a horizontal position. Rest on cart to move.

Inspection

- Annual Inspection** - The lift must be inspected at least once per year by a qualified technician certified by Human Care. Replace lift belt at a minimum every second year as a preventative action.
- Monthly Inspection** - Check lift belts for damage or wear. Feed entire length to ensure proper functioning.
- Daily Inspection** - Always inspect the lift for visible signs of damage before use. Ensure the lift is correctly mounted on the distance strap or rail roller. Always check slings and belts for signs of wear before use. Do not use if wear evident.

Troubleshooting

- **If the indicator light is not on, check the following:**
 - Mains switch is on
 - Batteries are fully discharged - charge or replace
 - Emergency stop button is not activated
- **If the indicator light is flashing, check the following:**
 - Hand control button does not function up/down when depressed (replace if necessary)
 - When pressing up, the lift is not already in its maximum upper position (lower with down button)
 - When pressing down, the lift is not already in its maximum lower position (raise with up button)
- **If the indicator light is constant red:**
 - The lift motor is overheated - allow to cool
 - The lift is overloaded - lower using emergency lowering button
- **If the indicator light is constant yellow:**
 - Charging in progress
- **If the indicator changes to flashing red:**
 - The batteries need charging, patient may be lifted a few more times