

P-440



Owner's Manual

Use and Care

Troubleshooting

Warranty Information

Table of Contents

P-440 Lift

| | |
|--|----|
| Introduction..... | 3 |
| Overview | 3 |
| Components of lift system | 4 |
| Component List..... | 5 |
| Specifications..... | 5 |
| Cautions | 7 |
| Operation | |
| Turning the lift ON and Automatic OFF..... | 8 |
| Raising/lowering the carry bar..... | 9 |
| Moving the lift along the track..... | 10 |
| Mounting the lift to the track | 11 |
| Basics in transferring an individual..... | 12 |
| Charging the lift | 14 |
| Emergency Lowering..... | 15 |
| Emergency Stopping and Shut-Off | 15 |
| Attaching the airline to the lift | 16 |
| Cleaning, Disinfection and Sterilization | 17 |
| Turning the Hooks Upwards | 17 |
| Troubleshooting..... | 18 |
| General inspection and maintenance..... | 19 |
| Lift accessories | 20 |
| Service record history | 21 |
| Warranty..... | 25 |



CAUTION: DO NOT ATTEMPT TO USE THIS EQUIPMENT WITHOUT FIRST UNDERSTANDING THE CONTENTS OF THIS MANUAL.

Introduction

Before using this equipment, and to ensure the safe operation of your P-440 lift carefully read this entire manual, especially the section on “Cautions”. The P-440 is designed to be used in conjunction with Prism Medical lift track, accessories and slings. Please refer to any user guides supplied with these components and reference them while reviewing this manual.

Should any questions arise from reviewing this manual contact your local authorized Prism Medical dealer. Failure to comply with warnings in this manual may result in injury to the operator, or the individual being lifted/transferred. Damage to the lift and/or related components may occur. Be sure that the contents of this manual are completely understood prior to using this piece of equipment.

Store this manual with the documents included with the lift system and sling (s). Contents of this manual are subject to change without prior written notice.

Overview of P-440 lift system

The P-440 lift is a lifting aid used by health care professionals and those providing care in the home to lift, position and transfer clients or a disabled family member. The P-440 lift is part of what is termed ceiling lift technology which takes advantage of lifting from above and not from below or the side. Additionally the ceiling lift does not take up valuable floor space as most traditional methods do. Finally, the ceiling lift makes it possible to move mobility impaired individuals with minimal strain or risk to the caregiver, while providing complete safety, dignity and comfort for the client or family member.

The P-440 lift is one of four major components that make up this technology. The other three components are the track, trolley and sling. The P-440 lift runs on the lift track which is securely mounted to the ceiling structure of the institution, or home with the use of ceiling brackets. The track itself is made of specially designed aluminum and comes in many different shapes, lengths and configurations, and is custom tailored and installed to meet your specific requirements. The third component, the sling, is a specially designed fabric accessory that attaches to the lift carry bar hooks by the sling straps, and holds an individual while the lift, positioning or transfer takes place. The fourth component, the trolley, is mounted inside the track and has wheels that allow the lift to move along the track. The lift attaches to the trolley by means of the eyelet of the trolley. The track, trolley and sling are supplied with the lift at the initial time of purchase.

The P-440 lift is a portable ceiling lift. It is designed to be easily moved from one track location to another. Track are typically installed in the bedroom, bathroom and/or the living room. The P-440 lift has the ability to lift an individual up from one location such as bed, move the individual along the track to another location and finally lower the individual into a chair or bathtub. It is moved along the track manually with the aid of a caregiver. The functions of lifting up or down are accomplished by pressing the buttons of a pneumatically (air) operated hand control. The hand control is attached to the lift by way of a rubber airline tubing. The P-440 lift is powered by batteries and it is supplied with an easy to use battery charger.

Please refer to figure 1A to see a sample floor plan of an installed lift system and figure 1B to see a photo of the P-440. Refer to figures 2A, 2B, 3A and 3B to familiarize yourself with the components of the P-440 lift, and charger.

Components of the P-440 Lift system

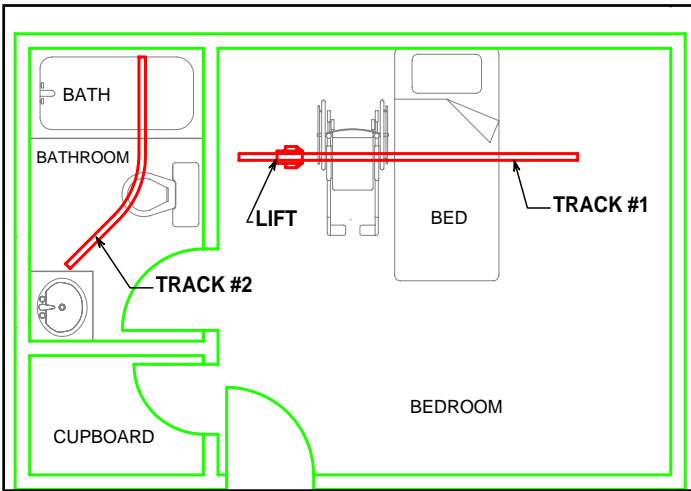

Figure 1A - Sample floor plan showing basic components of a portable ceiling lift system.

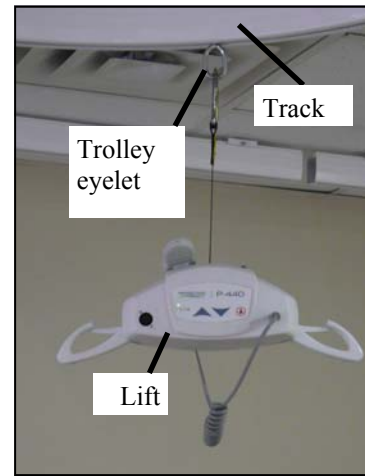

Figure 1B - P-440 Lift mounted onto track

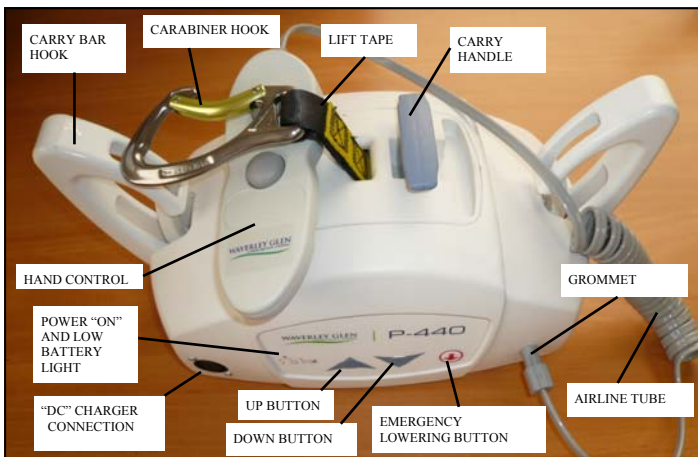

Figure 2A - Front View of P-440 lift



Figure 2B - Back view of P-440 lift

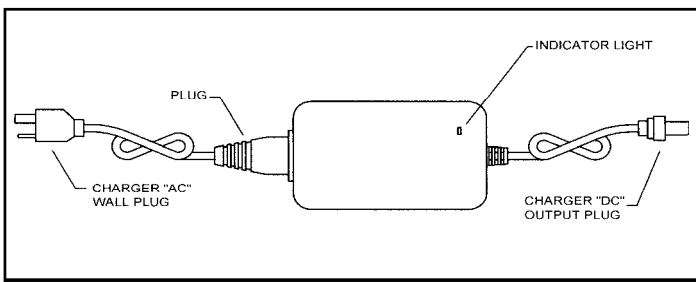

Figure 3A - Charger for P-440 lift

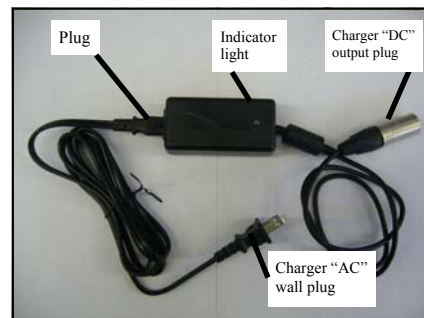

Figure 3B - Charger for P-440 lift

Component List

The following components are included with your new P-440 lift system:

- P-440 lift
- Pneumatic Hand Control
- Lift Charger
- Owner’s Manual
- Warranty Card

SLINGS: If a sling has been supplied with the lift refer to the instructions included with the sling.

ACCESSORIES: If additional accessories such as a turntable, or gate system, have been supplied with the lift refer to the instructions included with those items.

IMPORTANT: Before initial use, the lift unit must be charged for 5 hours. Refer to section titled "Charging Instructions". The hand control airline tube must also be connected to the lift. If it is not connected refer to the section titled “Attaching the airline to the lift”.

Specifications of P-440 lift

- Lift Motor:** 24 VDC
- Charger Input:** 100-240 VAC, 0.5 Amps
- Charger Output:** 29.4 VDC, 0.5 Amps
- Batteries:** 24 VDC (2 x 12 VDC) 2.3 AH
- Lift Case:** Flame Retardant ABS
- Hand Control:** Pneumatic – Piston Displacement
- Lifting Range:** Up to 1.96m
- Lift Weight:** 10.5 lbs (4.8 kg)
- Maximum Load:** 440 lbs (199.5 kg)
- Internal Fuses:** 15 Amp
- Duty Cycle:** 1 min “ON”, 9 mins “OFF”
- Rated Performance:** 5-10 lifts at 440 lbs, 10% duty cycle, each lift being 24 inches at the middle of the lifting range (from 54” strap out to 30” strap out) per full battery

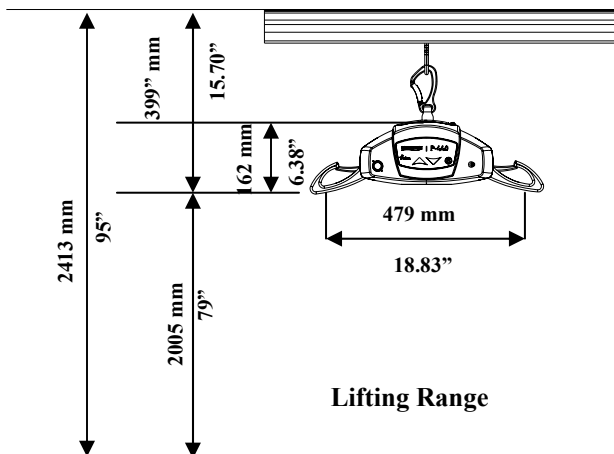

| Models Table for P-440 Lifts | |
|------------------------------|---|
| Code | Description |
| 303070 | P-440 lift including charger and pneumatic hand control |

Shipping/Storage Conditions:

- Temperature: Shipping/Storage: -40 to +70 °C
- Relative Humidity: Shipping/Storage: 10 to 100% RH
- Atmospheric Pressure: Shipping/Storage: 500 to 1060 hPa

NOTES:

- Please use the following type of plug for P-440 lifts installed in the UK:

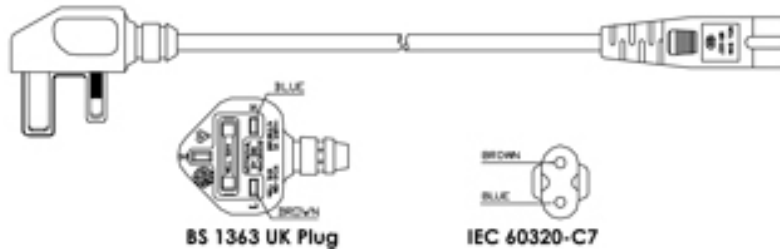

- Please use the following type of plug for P-440 lifts installed in Australia.

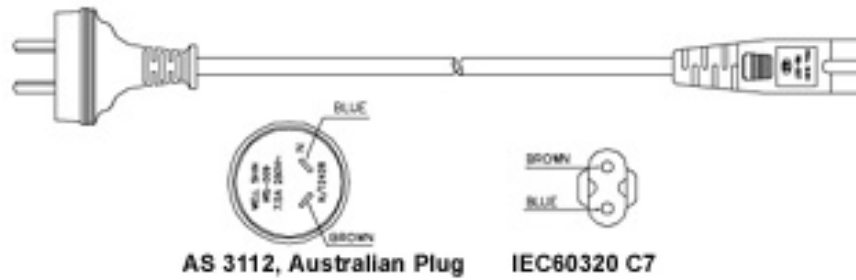

- The P-440 lift shall be connected to a center-tapped single phase supply circuit when users in the United States connect the equipment to a 240 V supply system.

Glossary of Symbols used in the P-440

| Mark | Symbol | Reference | Title | Mark | Symbol | Reference | Title |
|------|--------|----------------|---|------|--------|----------------|--------------------------|
| X | | IEC 60417-5172 | CLASS II equipment | X | | IEC 60417-5840 | TYPE B APPLIED PART |
| X | | ISO 7000-0434 | Caution risk of danger or Attention, consult ACCOMPANYING DOCUMENTS | X | | IEC 60417-5010 | “ON” / “OFF” (push-push) |
| X | | IEC 60417-5172 | CLASS II equipment | | | | |

Cautions

- The P-440 must be installed prior to use. Contact your local authorized dealer to ensure that it is properly installed. The P-440 must be installed only by persons authorized by Prism Medical.
- Under no circumstance should the track, lift and sling (s) or entire system be put in control of a person who has not been properly trained in the use and care of this equipment. Failure to adhere to this warning may result in serious injury to the operator, and/or the individual being lifted/transferred.
- The P-440 lift and associated track and sling (s) are not toys. Do not use them for unsafe practices. Do not allow children to play with the lift or any of its components.
- The manufacturer's warranty is void if persons unauthorized by Prism Medical perform work on the P-440 lift system.
- There are no user serviceable parts inside the cover. Do not remove cover screws, or open the lift unit, as this will **VOID THE WARRANTY**.
- In facilities where more than one operator will be responsible for using the P-440 associated track and sling (s) it is imperative that all such members be trained in its' proper use. A training program should be established by the facility to acquaint new operators with this equipment.
- Never expose the P-440 directly to water. Warranty does not cover any misuse or abuse of the lift system.
- To maintain optimum function, the P-440 should be inspected and maintained on a regular basis. See the section titled "General Inspection and Maintenance".
- Any accessories used with the P-440, including track and sling(s), should be checked to ensure that they are in good working order. Check for signs of wear or fraying prior to use. Report any unusual wear or damage immediately to your local authorized dealer.
- The P-440 and associated lift, track and sling (s) are intended **only** for lifting and transferring of a person. Prism Medical will not be responsible for any damage caused by the misuse, neglect or purposeful destruction of the lift and/or its' associated components.
- Do not in any circumstance exceed the maximum load of this lift. Refer to the "Specifications" section of this manual, and/or the labels on the side of the lift.
- The installation of the lift, track, accessories, and sling are certified to a maximum load. Do not exceed the maximum rated load of any of the components.
- There is a risk of explosion if the lift is used in the presence of flammable anaesthetics.
- Ensure that a clear space is maintained around the lift and track. Remove all curtain material and other obstacles out of the way before performing a transfer.

Operation

⚠ Caution: Always, before using the P-440 lift system, the lift, track and sling (s) must be visually checked for any unusual wear and tear. Refer to the user manual with each piece of supplied equipment to determine what should be checked. Should anything look unusual then contact your local dealer prior to use.

Failure to comply with this caution could result in serious injury to the operator, the individual being lifted and/or damage to the lift.

Turning the lift ON and Automatic OFF



To operate the lift it must first be turned ON. This can be done in several ways. The first method is to press the blue UP or DOWN buttons located in the middle front side of the lift. When this is done the ON/OFF indicator light located on the front left side of the lift will turn GREEN indicating that the lift is ON. Refer to figures 4B and 4C.



An alternative method is to press either the Grey UP or DOWN buttons on the hand control. Refer to figure 4A. When this is done the ON/OFF indicator light located on the front left side of the lift will turn GREEN indicating that the lift is ON. Refer to figure 4B.

To conserve battery power the lift will automatically shut off after approximately 2 minutes of non-use.

Figure 4A - Methods to Turn the P-440 "ON"

⚠ Note, it is recommended that when the lift is not in use and not in charge that the Red Emergency Stop be "OFF".

The light will turn ORANGE on the lift control panel and a slow beeping audible alarm will sound if the batteries are low and require charging. Complete the transfer that is in progress and then plug in the charger's DC output connector to the lift to recharge. Following the ORANGE indicator, the light will turn RED on the lift control panel and a fast beeping audible alarm will sound indicating the batteries are fully discharged and require charging. When the battery is discharged the UP function will be disabled. The DOWN and EMERGENCY DOWN function will continue to operate. See figure 4D.

When the lift is connected to the charger and turned ON, the indicator light on the lift will FLASH ORANGE. Once the lift automatically turns OFF the indicator light will change to a solid ORANGE. This indicates that the lift is on charge. After one hour, the lift may be used, however, overnight charging is recommended. During charging the UP/DOWN functions will be disabled. The EMERGENCY DOWN function will continue to operate.

If the lift does not automatically turn itself off and it is significantly longer than 2 minutes contact your dealer. When the lift is not in use and not in charge, turn the Red Emergency Stop Button to OFF.

⚠ Note: When in charge it is essential that the Red Emergency Stop Button is ON or else the lift will not charge.



Figure 4B - The indicator light of the lift is normally off when not in use.



Figure 4C - When the lift has been turned "ON", the indicator light will turn green.

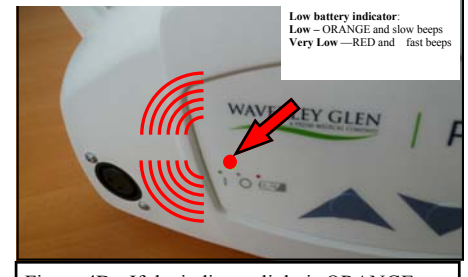

Figure 4D - If the indicator light is ORANGE or RED in color then the batteries of the lift are low and should be charged.

Operation

Raising/lowering the lift

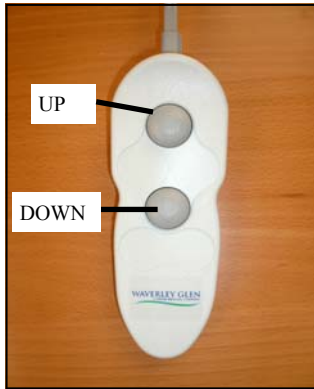

Figure 5A - Hand control

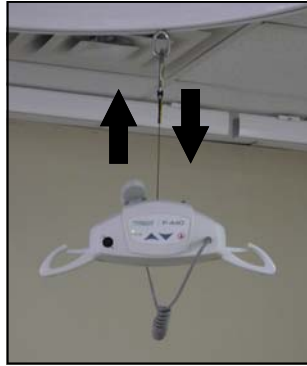

Figure 5B - Lift will move up and down the strap when the UP/DOWN buttons are pressed.

By pressing the DOWN arrow button, or the UP arrow button, the lift can be lowered or raised to the correct height for attaching the sling or positioning an individual. Refer to figure 5A and 5B

It is recommended that the caregiver (operator) steady the lift with one hand when it is close to the individual in the sling so that it will not accidentally sway and bump the individual or close object.

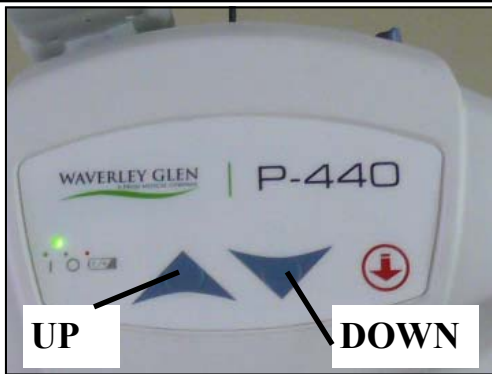

Figure 5C - Hand control showing raising/lowering buttons

Alternatively, located in the middle front side of the lift unit is a panel that has UP and DOWN buttons. By pressing the DOWN arrow button, or the UP arrow button, the lift can be lowered or raised to the correct height for attaching the sling or positioning an individual. Refer to figure 5C.

It is recommended that the caregiver (operator) steady the lift with one hand when it is close to the individual in the sling so that it will not accidentally sway and bump the individual or close object.

Moving the lift along the track

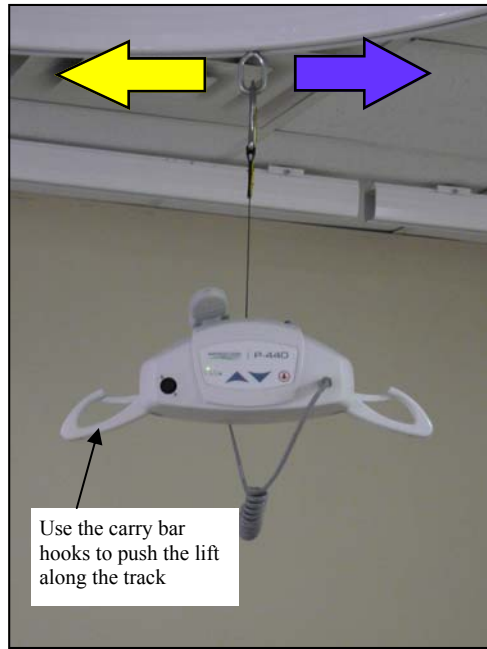

Figure 6A - The lift is moved along the track manually, by pushing it with the hand. The trolley located inside the track will glide the lift along.

The lift can be easily moved along the track by simply pushing it by hand.

For ease of use it is recommended that the lift be first lowered to a comfortable height at which it can easily be pushed along the length of the track by hand.

Care must be taken when moving the lift along the track. Ensure that the lift or the individual in the sling of the lift does not come into contact with any objects such as desks, counters, walls, etc..

⚠ Caution: Always be cautious when moving an individual along the track. Watch out for and avoid any obstructions that may cause injury to the individual in the sling or damage to the lift.

⚠ Caution: Use the sling straps to move the lift when lifting a patient. This technique prevents the caregiver from developing shoulder injuries.

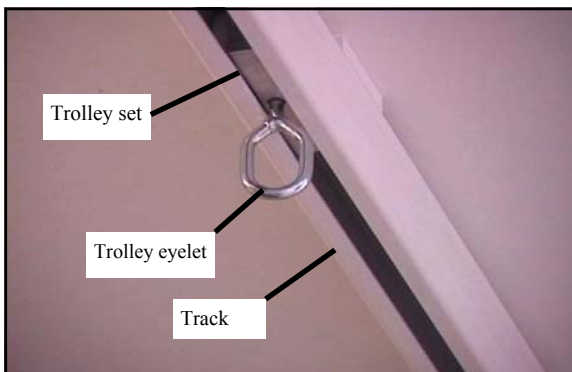

Figure 7A - Photo showing the lift trolley that is installed along the inside of the track. The eyelet of the trolley connects to the hook of the lift in one of several ways.

The lift moves along the track by means of a trolley assembly that is mounted inside the track. Each track location will have one of these trolleys installed.

The eyelet of the trolley hangs down below the track and provides the way of connecting the lift to the track. The wheels of the trolley are designed to move the lift along the track with very little effort.

Mounting the lift to the track

The first step in being able to use the P-440 lift is to mount it onto the trolley of the lift track. There are several ways of making this connection. Refer to figures 8A through to 11B to determine the type of ceiling connection that has been installed with the purchased system.

⚠ Caution: Always check to ensure that the lift hook is attached properly to the eyelet of the trolley, or the reacher, or the lanyard. The safety latch of the lift hook must always be in a locked position as shown in the close-up photos 8B, 9B, 10B and 11A.

Option 1 - Direct connection to trolley



Figure 8A - Photo showing connection of lift hook directly to the eyelet of the trolley.

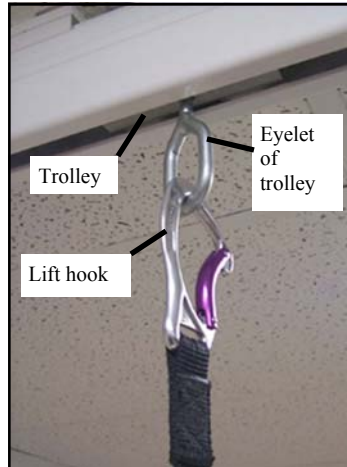

Figure 8B - Photo showing close-up of lift hook connected directly to eyelet of trolley.

Option 2 - Connection with reacher



Figure 9A - Photo showing P-440 lift carabiner connected to a reacher first and then to the eyelet of the trolley.

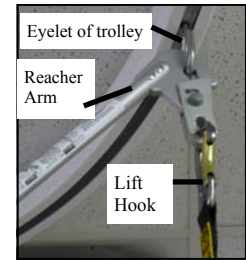

Figure 9B - Photo showing close-up of P-440 lift carabiner connected to a reacher first and then to the eyelet of the trolley.

Option 3 - Connection with lanyard

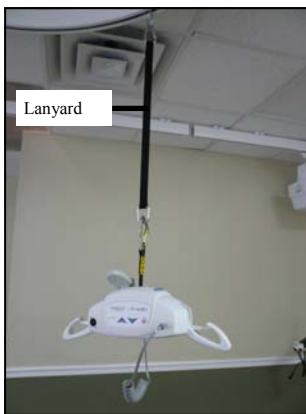

Figure 10A - Photo of lift hook connected to a P-440 lanyard first and then to the eyelet of the trolley.

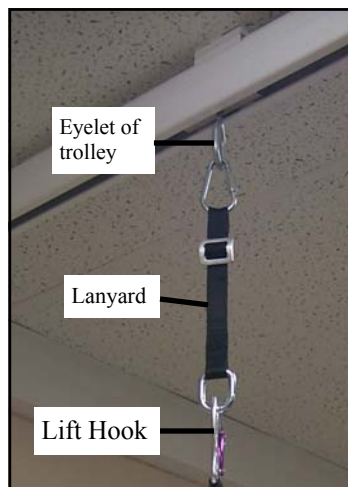

Figure 10B - Photo showing close-up of lift hook, lanyard and eyelet of trolley.

Option 4 - Connection with lanyard and Reacher arm Carabiner.

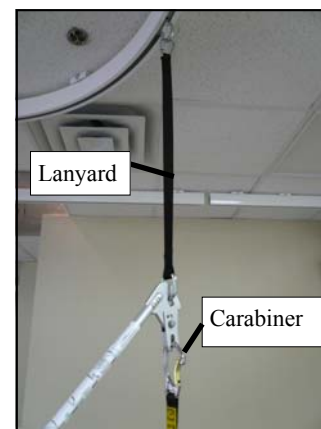

Figure 11A - Photo showing lift hook connected to a reacher & lanyard and finally to the eyelet of the trolley.

Basics in transferring an individual

⚠ Caution: The following steps are intended to generally describe the procedure involved in the lifting and transferring of an individual from one location to another using the lift, track and sling. Track configurations will vary by installation.

The manual for the sling that was purchased with the lift should be reviewed in detail prior to attempting these steps. Contact your local authorized dealer should you have any questions or concerns.

Step 1) Carry the P-440 Lift to the desired transfer location. Set it on a secure object such as a table or chair. Let sufficient strap out of the lift so that the lift hook can be easily attached to the eyelet of the trolley without having to lift the lift. Attach the lift hook to the eyelet of the trolley as noted in the previous section titled “Mounting the lift to the track”. Lower the lift to a comfortable level so that it can easily be moved. Move it close to the individual that is to be transferred. Use the procedures for up and down and moving along the track as described in the previous sections titled “Raising/Lowering the lift” and “Moving the lift along the track”.

⚠ Caution: Always be cautious when raising or lowering the lift, or moving the lift along the track. Watch out for and avoid any obstructions that may cause injury to the patient.

Step 2) Prepare the individual being transferred with the appropriate sling. Refer to the instructions supplied with the sling that was purchased on how to properly outfit an individual with a sling.

⚠ Caution: Always make sure that the sling is correctly fitted and adjusted on each side of the individual so that maximum comfort and safety are achieved prior to lifting. Refer to the sling instructions that were supplied with the sling.

Step 3) Once the individual has been outfitted with the sling, move the lift so that it is positioned **directly over** the individual. The lift may need to be raised or lowered, or re-positioned along the track in order to accomplish this. Lower the lift so that the carry bar hooks are at a height that makes connecting the straps of the sling easy to accomplish. Steady the lift with one hand so that it does not accidentally come in contact with the head or body of the individual to be lifted.

⚠ Caution: Always check to ensure that when the lift is lowered that it does not come in contact with the person being lifted. Steady the lift with one hand while it is being lowered near an individual.

⚠ Caution: Always check to ensure that the lift is correctly positioned directly above the person to be lifted. Over time, the lift strap may fray if this is not followed.

Step 4) Following the instructions provided with the sling. Attach the straps of the sling to the carry bar hooks of the lift. The straps on each side of the sling are generally attached to the corresponding side of the carry bar hooks. Be sure to double check to ensure that the straps are properly attached to the carry bar hooks, and that the individual being lifted is properly positioned in the sling prior to lifting.

⚠ Caution: Prior to lifting an individual make sure that the straps of the sling are securely placed on the carry bar hooks and that the straps will not come off .

Step 5) The individual may now be raised with the use of the UP button on the hand control or front panel button. While lifting is in progress the height required in order for the transfer to be completed should be closely observed. Ensure that the individual being lifted will not be injured by any obstructions during the initial lifting.

Basics in transferring an individual ... continued

Step 6) Once at the correct height the individual can be moved along the track to the desired location.

⚠ Caution: Always be cautious when moving an individual along the track. Watch out for and avoid any obstructions that may cause injury to the lift or individual in the sling.

Step 7) Once at the desired location the individual in the sling can be lowered/raised to the correct height in order to complete the transfer. On completion of lowering/raising ensure that the individual is properly positioned and safely supported prior to removing the straps of the sling.

⚠ Caution: Always be cautious when lowering/raising an individual who is in the sling of the lift. Watch out for and avoid any obstructions that may cause injury to the individual.

Step 8) Lower the lift sufficiently to allow the sling straps to be easily removed taking care not to let it come in contact with the individual in the sling.

⚠ Caution: Prior to removing the sling straps from the carry bar hooks be sure to check that the individual is securely and safely supported in the final desired position.

Step 9) The straps of the sling can now be removed from the carry bar hooks. The sling can then be removed from the individual and stored in a safe place until next use.

Step 10) The lift should now be raised sufficiently and moved away from the immediate area of the individual that was transferred. The lift will automatically turn itself OFF if not in use for 2 minutes.

Step 11) The lift can now be removed from track, relocated to another track, or stored in a safe place until next use. It is recommended that the lift be charged when not in operation. Refer to the section titled “Charging the lift” for details on charging.

⚠ Caution: Always use extreme care when removing the lift from the track. Lower the lift such that it is securely resting on a stable support object such as a dresser, cart or table prior to removal. This may be performed by either of the following methods:

- 1) Lower the lift so that the top of the P-440 is just below the surface of the support then lift the P-440 onto it or;**
- 2) Lower the P-440 on the support then with your spare hand apply gentle tension to the lifting strap to keep it taut while operating the down function with the other hand, noting this does not require force or lifting the P-440**

Use extreme care when re-locating the lift. Be sure it is securely held during transport.

Charging the lift

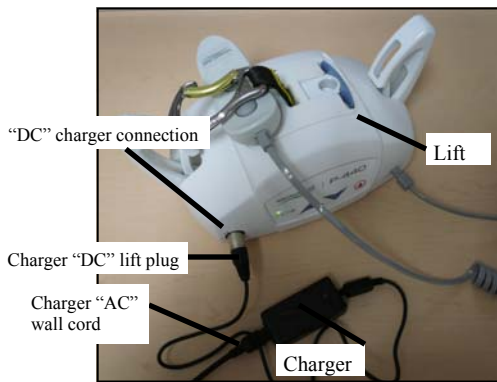

Figure 12A - P-440 lift and charger set on a secure table top or counter for charging.

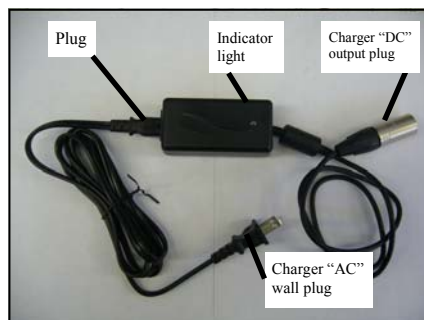

Figure 12B - Charger for P-440 lift

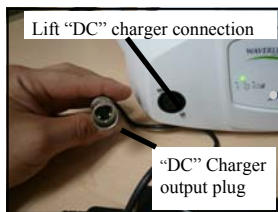

Figure 12C - Close-up of "DC" charger plug and lift "DC" charger connection. Note the 3 metal prongs on the end of the charger cord and 3 holes on the black "DC" connection.



Figure 12D - Connect the charger to the lift. Be sure to line up the 3 metal prongs on the end of the charger with the 3 holes in the black lift "DC" connection.



Figure 12E - Charger is connected to the lift. The indicator light on the charger will be ORANGE indicating that the lift is charging.

⚠ Caution: The charger must be located outside the patient vicinity at all times. The patient vicinity is the space with surfaces likely contacted by the patient or an attendant who can touch the patient. This space is 6 feet (1.83m) beyond the perimeter of the bed, examination table, etc., extending vertically 7-1/2 feet (2.29m) above the floor.

The batteries of the lift should be charged on a regular basis. It is recommended that the lift be left on charge when not in operation, and at the end of each day. This will maximize the life cycle of the batteries.

The lift may remain connected to the charger indefinitely since the charger has a built-in regulator, eliminating the danger of overcharging.

Step 1) Familiarize yourself with the basic components of the charging system. Refer to figures 12A and 12B.

Step 2) Place the lift and charger on a safe surface such as a table or counter top. The surface must be clean and dry, and away from the reach of a child.

Step 3) The lift turns "OFF" by itself if not in use for two minutes.

Step 4) Plug the charger "AC" wall plug into a nearby wall outlet. The indicator light on the charger will turn GREEN.

⚠ Caution: Do not use an electrical extension to extend the reach of the "AC" wall plug.

Step 5) Take hold of the charger "DC" output plug and visually observe that it has three (3) prongs inside of its metal case. These are designed to fit into the three (3) holes that are located on the black lift "DC" connection. Refer to figure 12C.

Step 6) Take the charger "DC" output plug and connect it to the black lift "DC" connection being careful to ensure that the metal prongs from the charger plug fit into the holes of the black lift connector. When this is completed correctly, then the indicator light on the charger will turn ORANGE. Refer to figures 12D, E.

⚠ Caution: Do not operate the lift while it is connected to the charger.

After a minimum of 1 hour the charger can be disconnected from the lift, and the lift put into use. However overnight charging is recommended.

⚠ Caution: Do not allow the batteries to become discharged below the low battery alarm, as this will decrease overall battery life and performance.

⚠ Caution: Use only the charger that was supplied with the lift. Use of any other charger will void all warranties and may cause damage to the lift.

Emergency Lowering



Figure 14A –Lift showing DOWN button located on front right side of lift.



Figure 14B –RED emergency lowering button located on middle of the front of the lift.

The DOWN blue button located on the front right side of the lift can be used to lower an individual should the hand control buttons fail. Refer to figure 14B.

Should both DOWN arrow buttons on the hand control, and the DOWN button of the lift fail, the person may be lowered by pressing the RED emergency lowering button located on middle front side of the lift. There will be a delay of approximately 2 seconds before the lift starts to lower. An audible alarm will also sound during the emergency lowering. Refer to figure 14B.

IMPORTANT: The Emergency Lowering system does not provide a raising function. The failure of any of the lowering device should be reported to your authorized dealer immediately.

Emergency Stopping and Shut-off



Figure 14C –RED Emergency stop switch located on the front left side of the lift.

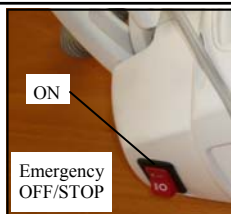

Figure 14D - Close-up of switch
ON - Normal lift Operation
OFF - Emergency Stop

The lift normally shuts off if the lift has not been in use for 2 minutes. Do not use the Red Emergency Stop Button as a ON/OFF switch. It is to be used only in case of Emergencies.

Should a situation present itself such that the lift will not respond to the hand control buttons or on any of the normal operational control buttons on the front of the lift then the **RED Emergency stop switch** should be switched to the “OFF “ position. **This will shut off power going to the motor of the lift and will immediately stop all movement.**

Should the emergency stop function be used in an emergency, and before the lift can be used again, it must be inspected by an authorized dealer. Once the lift has been inspected and/or repaired, then the Emergency Stop Button can be set to the “ON” position. Normal use of the lift may then proceed.

Note: The lift will only charge if the Emergency stop switch is in the “ON” position. Refer to the section titled, “Charging the lift” for charging instructions.

Attaching the airline tube to the lift



Figure 15A - Gray rubber grommet located on front right side of the lift. Rubber airline is not connected. Note ridge on grommet.



Figure 15B - Gray rubber airline being inserted into rubber grommet of lift. The ridges on both pieces are lined up. The metal ribbed pins are on the airline (within the shroud).

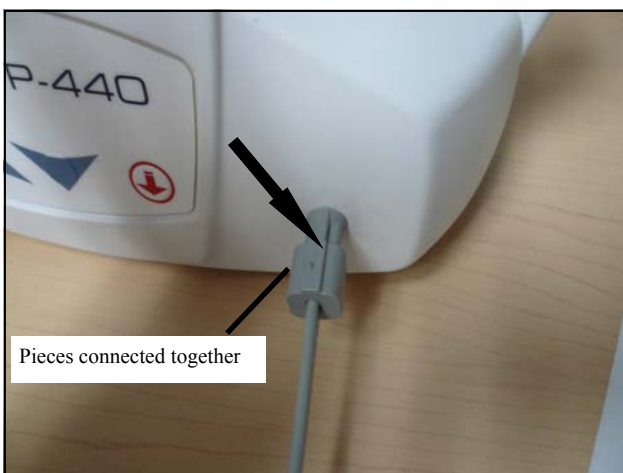

Figure 15C - Gray rubber airline being inserted into rubber grommet of lift. The ridges on both pieces are lined up. The metal ribbed pins are on the airline.

Should the gray rubber airline that connects the lift to the hand control become disengaged from the front left side of the lift it must be re-connected in order for the lift to work properly.

The rubber airline may become disconnected for the following reasons:

- 1) The lift is pulled along the track by the airline.
- 2) The tubing accidentally gets wrapped around an object while a lift or transfer is being performed.
- 3) It is accidentally pulled out by the caregiver or the individual being lifted.

The airline is connected to a gray rubber grommet located on the front left side of the lift. Refer to figure 15A.

Small metal ribbed pins located at the end of the airline hold the airline to this rubber grommet in a specific manner. Therefore it is important to make sure that the airline is connected properly.

Both the gray airline and the rubber grommet have a ridge on one of their sides. Align the ridges for proper connection. Refer to figure 15B. When this is done then the metal ribbed pins attached to the end of the airline can be re-inserted into the corresponding holes in the rubber grommet located on the front left side of the lift. Be sure to insert the pins into the gray rubber grommet sufficiently so that it is secure. Refer to figure 15C.

Perform a brief test of the lift to ensure proper connectivity. Turn the lift ON. Raise and lower the lift.

If the lift does not work properly, check to ensure that the ridges on the gray rubber grommet on the underside of the lift and the airline tubing are lined up properly. If they are not lined up properly, then remove the airline, line up the ridges and then re-insert it into the rubber grommet. Perform the test as noted in the preceding paragraph. If there are still problems with the lift then contact your local authorized dealer for service.

Cleaning, Disinfection and Sterilization

The exterior of the lift should only be cleaned, disinfected and sterilized using isopropyl alcohol. Damp a cloth with isopropyl alcohol and wipe down entire exterior of lift including strap and hook. No other chemicals and/or liquids should be used to clean, disinfect and sterilize this lift.

⚠ Caution: Take great care to ensure that no liquids get inside the lift. This lift is not drip proof or water tight. Failure to protect the lift from liquids may result in damage to the lift and/or may cause personal injury.

Turning the hooks upwards

The P-440 has a feature that allows for the hooks to be turned upwards as shown. This may be used for transporting or storing the lift.



Figure 16A - P-440 with hooks in normal position



Figure 16B - P-440 with hooks turned upwards.

Troubleshooting

Should problems arise with the use of the P-440 lift review the following chart. Find the fault and complete the recommended solution. If the fault is not found and/or the solution does not correct the problem contact your local authorized dealer for service immediately.

| Fault | Recommended Solution |
|---|--|
| The airline tubing that connects the hand control to the lift has become disengaged. | Refer to the section of this manual titled “Attaching the airline tube to the lift”. If this does not correct the problem then contact your local authorized dealer immediately so that the lift can be checked to ensure proper continued operation. |
| The hand control buttons do not operate according to their designations (e.g. the UP button initiates a down movement). | The airline tubing has not been connected correctly. Refer to the section of this manual titled “Attaching the airline and hand control to the lift”. If this does not correct the problem then contact your local authorized dealer immediately so that the lift can be checked to ensure proper continued operation. |
| The lift does not operate up or down even when the airline has been properly connected. | The indicator light on the front right side of the lift should be GREEN. Press the ON/OFF button or UP/DOWN arrow buttons on the hand control. This should activate the lift and the indicator light turn GREEN. If the lift still does not function, then the batteries may be low and require charging. Refer to the section of this manual titled “Charging the lift”. Charge the lift for at least one hour and then try to raise and lower it. |
| The GREEN light on the left front side of the lift is ON and the lift does not operate in the DOWN direction. | There is a built-in slack tape detector in the lift. This may be sensitive. Take hold of the lift strap about 10 centimetres above the top of the lift and pull it upwards in order to tighten the lift strap, and then press the DOWN button. If this corrects the problem temporarily but not permanently then contact your local authorized dealer so that the lift can be checked to ensure proper continued operation. |
| The red indicator light on the left front side of the lift turns RED and/or a loud alarm sound is heard when an individual is raised. | The batteries are low and require charging. Refer to the section of this manual titled “Charging the lift”. Charge the lift for at least one hour and then try to raise and lower it. If this does not correct the problem then contact your local authorized dealer immediately so that the lift can be checked to ensure proper continued operation. |
| One side of the lift tape (strap) is starting to fray after continued use. | Check to be sure that the lift is always directly above the individual being lifted. Refer to the section titled “Basics in transferring an individual” for correct lift positioning. If fraying still continues then contact your local authorized dealer immediately so that the lift can be checked to ensure proper continued operation. |
| The lift does not pass through a track component such as a turntable or gate. | Refer to the “Owners Manual” for the specific piece of equipment in question. If the recommended solution does not correct the problem then contact your local authorized dealer immediately so that the lift can be checked to ensure proper continued operation. |
| | |

General Inspection and Maintenance

A) Each Use - To be completed by User

Prior to each use the P-440 lift and associated track, accessories and sling (s), must be visually inspected. Refer to the accessory and sling user guides for specific details regarding their inspection.

Should any of the these items fail the inspection do not use the lift
Contact your local authorized dealer for service.

Visually check for the following:

- The lift strap shows NO signs of fraying or breaking along its entire length.
 - The stitching on the lift strap where it connects to the lift hook shows NO signs of fraying or breaking.
 - The sling (s) that will be used show NO signs of unusual wear or damage. The straps of the sling that connect to the carry bar hooks of the lift show NO signs of fraying or breaking.
 - The airline tube that connects the hand control to the lift is not kinked, twisted, knotted, cut or damaged.
 - All the functions on the hand control work correctly (e.g. UP/DOWN).
 - The brackets that hold the track in place on the ceiling are secure and do not move or appear loose.
 - The lift has no unusual sounds when it is moved UP/DOWN or along the track..
 - Ensure that there are end stops installed at each end of the track.
 - There are not cuts, dents or sharp edges on the carry bar hooks that may damage straps of the sling.
 - The carabiner hook shall be visually inspected before and after each lift for damages.
-

B) Monthly - To be completed by User

Should any of the these items fail the inspection do not use the lift.
Contact your local authorized dealer for service.

- Complete the visual inspection as noted in the “Each Use” section above.

With no one in the sling nor attached to the lift check the following:

- The lift moves freely along the entire length of the track.
-

C) Semi-Annual or Yearly - To be completed by a lift technician

Consult your local authorized dealer for advice on whether this section should be completed every 6 months or on a yearly basis. Generally, in frequent use, or in situations where heavier than normal clients are lifted, or in multi-user environments such as in institutions the lift should be checked every 6 months.



This section to be only completed by a qualified service technician as authorized by Prism Medical

- Complete the visual inspection as noted in the “Monthly” section above.
- Lift checked and passed. Any required repairs completed.

Lift Accessories

The following is a list of available accessories for the P-440 lift. Items such as the track, turntables and brackets are installed at the time of purchase. Add-on pieces are available to after the initial purchase, however your local authorized dealer must be consulted as to suitability, purchase and installation.

Slings are the most common after purchase accessory. A variety of styles, sizes, and colors are available. Custom slings can also be manufactured to meet special needs. Consult your local authorized dealer for details, pricing and a complete list of current sling models.

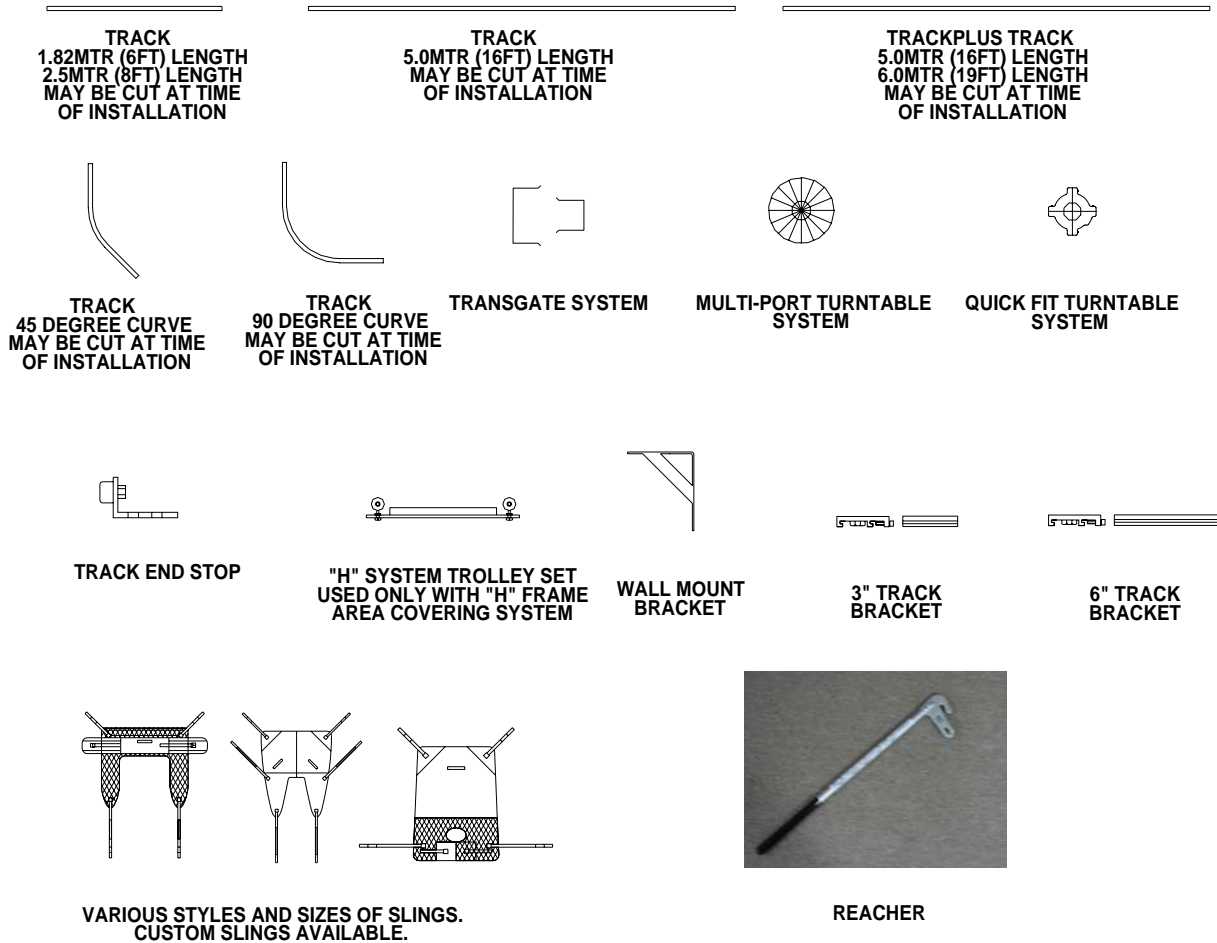

**ACCESSORIES NOT TO SCALE.
FOR ILLUSTRATIVE PURPOSES ONLY.**

**NOTICE: ACCESSORY SIZE, STYLE, SHAPE, LENGTH,
CONFIGURATIONS, OPTIONS, COLOURS AND
SPECIFICATIONS
MAY CHANGE WITHOUT PRIOR WRITTEN NOTICE.**

CONTACT YOUR LOCAL AUTHORISED DEALER FOR DETAILS.

CAUTION: ONLY SLINGS AUTHORIZED BY PRISM MEDICAL ARE TO BE USED WITH THIS LIFT. CONTACT YOUR LOCAL AUTHORIZED DEALER FOR DETAILS.

Service Record History - Initial Information

- Complete the following section on **Purchase and Service Information** as soon as this equipment is installed.
- Use the service record history to record to any completed service and repairs.
- Ensure that the service record is signed and dated each time it is used.
- Be sure to have this piece of equipment serviced on a regular basis as described in the General Inspection and Maintenance Section

PURCHASE INFORMATION:

Product Name: P-440 lift **Model:** _____

Serial#: _____

Date of Purchase: _____ **Date Installed:** _____

Purchased From: _____

Address: _____

City: _____ **Postal Code:** _____

Telephone No: _____

Comments:

SERVICE INFORMATION:

Contact the following company for service:

Company: _____

Address: _____

City: _____ **Postal Code:** _____

Telephone No: _____

Comments:

Service Record History

Complete this section after each service, repair inspection and/or maintenance. Photocopy additional pages as required.

| | | | |
|--|--|--------------------|--|
| Date: _____ | | Time: _____ | |
| Service Type: <input type="checkbox"/> Periodic Inspection <input type="checkbox"/> Monthly Inspection <input type="checkbox"/> 6 Month Inspection <input type="checkbox"/> Repair <input type="checkbox"/> Yearly Inspection <input type="checkbox"/> Other: _____ | | | |
| Completed By: _____ | | _____ | |
| Printed Name | | Signature | |
| Company: _____ | | | |
| Remarks & Action Taken: | | | |

| | | | |
|--|--|--------------------|--|
| Date: _____ | | Time: _____ | |
| Service Type: <input type="checkbox"/> Periodic Inspection <input type="checkbox"/> Monthly Inspection <input type="checkbox"/> 6 Month Inspection <input type="checkbox"/> Repair <input type="checkbox"/> Yearly Inspection <input type="checkbox"/> Other: _____ | | | |
| Completed By: _____ | | _____ | |
| Printed Name | | Signature | |
| Company: _____ | | | |
| Remarks & Action Taken: | | | |

| | | | |
|--|--|--------------------|--|
| Date: _____ | | Time: _____ | |
| Service Type: <input type="checkbox"/> Periodic Inspection <input type="checkbox"/> Monthly Inspection <input type="checkbox"/> 6 Month Inspection <input type="checkbox"/> Repair <input type="checkbox"/> Yearly Inspection <input type="checkbox"/> Other: _____ | | | |
| Completed By: _____ | | _____ | |
| Printed Name | | Signature | |
| Company: _____ | | | |
| Remarks & Action Taken: | | | |

| | | | |
|--|--|--------------------|--|
| Date: _____ | | Time: _____ | |
| Service Type: <input type="checkbox"/> Periodic Inspection <input type="checkbox"/> Monthly Inspection <input type="checkbox"/> 6 Month Inspection <input type="checkbox"/> Repair <input type="checkbox"/> Yearly Inspection <input type="checkbox"/> Other: _____ | | | |
| Completed By: _____ | | _____ | |
| Printed Name | | Signature | |
| Company: _____ | | | |
| Remarks & Action Taken: | | | |

| | | | |
|--|--|--------------------|--|
| Date: _____ | | Time: _____ | |
| Service Type: <input type="checkbox"/> Periodic Inspection <input type="checkbox"/> Monthly Inspection <input type="checkbox"/> 6 Month Inspection <input type="checkbox"/> Repair <input type="checkbox"/> Yearly Inspection <input type="checkbox"/> Other: _____ | | | |
| Completed By: _____ | | _____ | |
| Printed Name | | Signature | |
| Company: _____ | | | |
| Remarks & Action Taken: | | | |

| | | | |
|--|--|--------------------|--|
| Date: _____ | | Time: _____ | |
| Service Type: <input type="checkbox"/> Periodic Inspection <input type="checkbox"/> Monthly Inspection <input type="checkbox"/> 6 Month Inspection <input type="checkbox"/> Repair <input type="checkbox"/> Yearly Inspection <input type="checkbox"/> Other: _____ | | | |
| Completed By: _____ | | _____ | |
| Printed Name | | Signature | |
| Company: _____ | | | |
| Remarks & Action Taken: | | | |

Service Record History

Complete this section after each service, repair inspection and/or maintenance. Photocopy additional pages as required.

| | | | |
|--|--|--------------------|--|
| Date: _____ | | Time: _____ | |
| Service Type: <input type="checkbox"/> Periodic Inspection <input type="checkbox"/> Monthly Inspection <input type="checkbox"/> 6 Month Inspection <input type="checkbox"/> Repair <input type="checkbox"/> Yearly Inspection <input type="checkbox"/> Other: _____ | | | |
| Completed By: _____ | | _____ | |
| Printed Name | | Signature | |
| Company: _____ | | | |
| Remarks & Action Taken: | | | |

| | | | |
|--|--|--------------------|--|
| Date: _____ | | Time: _____ | |
| Service Type: <input type="checkbox"/> Periodic Inspection <input type="checkbox"/> Monthly Inspection <input type="checkbox"/> 6 Month Inspection <input type="checkbox"/> Repair <input type="checkbox"/> Yearly Inspection <input type="checkbox"/> Other: _____ | | | |
| Completed By: _____ | | _____ | |
| Printed Name | | Signature | |
| Company: _____ | | | |
| Remarks & Action Taken: | | | |

| | | | |
|--|--|--------------------|--|
| Date: _____ | | Time: _____ | |
| Service Type: <input type="checkbox"/> Periodic Inspection <input type="checkbox"/> Monthly Inspection <input type="checkbox"/> 6 Month Inspection <input type="checkbox"/> Repair <input type="checkbox"/> Yearly Inspection <input type="checkbox"/> Other: _____ | | | |
| Completed By: _____ | | _____ | |
| Printed Name | | Signature | |
| Company: _____ | | | |
| Remarks & Action Taken: | | | |

| | | | |
|--|--|--------------------|--|
| Date: _____ | | Time: _____ | |
| Service Type: <input type="checkbox"/> Periodic Inspection <input type="checkbox"/> Monthly Inspection <input type="checkbox"/> 6 Month Inspection <input type="checkbox"/> Repair <input type="checkbox"/> Yearly Inspection <input type="checkbox"/> Other: _____ | | | |
| Completed By: _____ | | _____ | |
| Printed Name | | Signature | |
| Company: _____ | | | |
| Remarks & Action Taken: | | | |

| | | | |
|--|--|--------------------|--|
| Date: _____ | | Time: _____ | |
| Service Type: <input type="checkbox"/> Periodic Inspection <input type="checkbox"/> Monthly Inspection <input type="checkbox"/> 6 Month Inspection <input type="checkbox"/> Repair <input type="checkbox"/> Yearly Inspection <input type="checkbox"/> Other: _____ | | | |
| Completed By: _____ | | _____ | |
| Printed Name | | Signature | |
| Company: _____ | | | |
| Remarks & Action Taken: | | | |

| | | | |
|--|--|--------------------|--|
| Date: _____ | | Time: _____ | |
| Service Type: <input type="checkbox"/> Periodic Inspection <input type="checkbox"/> Monthly Inspection <input type="checkbox"/> 6 Month Inspection <input type="checkbox"/> Repair <input type="checkbox"/> Yearly Inspection <input type="checkbox"/> Other: _____ | | | |
| Completed By: _____ | | _____ | |
| Printed Name | | Signature | |
| Company: _____ | | | |
| Remarks & Action Taken: | | | |

Service Record History

Complete this section after each service, repair inspection and/or maintenance. Photocopy additional pages as required.

| | | | |
|--|--|--------------------|--|
| Date: _____ | | Time: _____ | |
| Service Type: <input type="checkbox"/> Periodic Inspection <input type="checkbox"/> Monthly Inspection <input type="checkbox"/> 6 Month Inspection <input type="checkbox"/> Repair <input type="checkbox"/> Yearly Inspection <input type="checkbox"/> Other: _____ | | | |
| Completed By: _____ | | _____ | |
| Printed Name | | Signature | |
| Company: _____ | | | |
| Remarks & Action Taken: | | | |

| | | | |
|--|--|--------------------|--|
| Date: _____ | | Time: _____ | |
| Service Type: <input type="checkbox"/> Periodic Inspection <input type="checkbox"/> Monthly Inspection <input type="checkbox"/> 6 Month Inspection <input type="checkbox"/> Repair <input type="checkbox"/> Yearly Inspection <input type="checkbox"/> Other: _____ | | | |
| Completed By: _____ | | _____ | |
| Printed Name | | Signature | |
| Company: _____ | | | |
| Remarks & Action Taken: | | | |

| | | | |
|--|--|--------------------|--|
| Date: _____ | | Time: _____ | |
| Service Type: <input type="checkbox"/> Periodic Inspection <input type="checkbox"/> Monthly Inspection <input type="checkbox"/> 6 Month Inspection <input type="checkbox"/> Repair <input type="checkbox"/> Yearly Inspection <input type="checkbox"/> Other: _____ | | | |
| Completed By: _____ | | _____ | |
| Printed Name | | Signature | |
| Company: _____ | | | |
| Remarks & Action Taken: | | | |

| | | | |
|--|--|--------------------|--|
| Date: _____ | | Time: _____ | |
| Service Type: <input type="checkbox"/> Periodic Inspection <input type="checkbox"/> Monthly Inspection <input type="checkbox"/> 6 Month Inspection <input type="checkbox"/> Repair <input type="checkbox"/> Yearly Inspection <input type="checkbox"/> Other: _____ | | | |
| Completed By: _____ | | _____ | |
| Printed Name | | Signature | |
| Company: _____ | | | |
| Remarks & Action Taken: | | | |

| | | | |
|--|--|--------------------|--|
| Date: _____ | | Time: _____ | |
| Service Type: <input type="checkbox"/> Periodic Inspection <input type="checkbox"/> Monthly Inspection <input type="checkbox"/> 6 Month Inspection <input type="checkbox"/> Repair <input type="checkbox"/> Yearly Inspection <input type="checkbox"/> Other: _____ | | | |
| Completed By: _____ | | _____ | |
| Printed Name | | Signature | |
| Company: _____ | | | |
| Remarks & Action Taken: | | | |

| | | | |
|--|--|--------------------|--|
| Date: _____ | | Time: _____ | |
| Service Type: <input type="checkbox"/> Periodic Inspection <input type="checkbox"/> Monthly Inspection <input type="checkbox"/> 6 Month Inspection <input type="checkbox"/> Repair <input type="checkbox"/> Yearly Inspection <input type="checkbox"/> Other: _____ | | | |
| Completed By: _____ | | _____ | |
| Printed Name | | Signature | |
| Company: _____ | | | |
| Remarks & Action Taken: | | | |

Warranty

This Warranty does not affect or in any way limit your Statutory Rights

- 1) Subject to the exclusions set out in Clause 2, the conditions set out in Clause 3 and the limitations set out in Clause 4, Prism Medical, as sole licensed representative of Corven Healthcare Inc., guarantees all equipment supplied as new against failure within the period of 1 year from date of purchase by virtue of defects in material or workmanship.
- 2) This guarantee does not apply to failure attributable to normal wear and tear, damage by natural forces, user neglect or misuse or to deliberate destruction, or to batteries more than 90 days after original purchase.
- 3) This guarantee shall be void if the equipment is not serviced by Prism Medical or its authorized service agents in accordance with the manufacturer's recommendations or if any unauthorized person carries out works on the equipment.
- 4) The liability of Prism Medical under the terms of this guarantee shall be limited to the replacement of defective parts and in no event shall Prism Medical incur liability for any consequential or unforeseeable losses.

If you have any questions about the manufacture or operation
of this equipment, please contact
Prism Medical, or your local authorized dealer.



Prism Medical: www.prismmedicaltd.com

45 Progress Parkway
Maryland Heights, MO. 63043
USA

Telephone: (314) 692-9135 Fax: (314) 692-7858

Toll Free: 1-866-891-6502

This document conforms to EN ISO 10535 requirements

™ Trade-mark of Corven Health Care Inc. Used under licence.

E.& O.E.