

OXYNOVA™
HYPERBARIC

5789



user manual



20 years strong.

We've reached our 20 years benchmark manufacturing inflatable hyperbaric chambers with the highest engineering standard.

Notice of discharge

This document is not intended to replace the advice of a physician or any health specialist. The information and allegations found on the sites, flyers, booklets and other documents bearing the Oxynova® product line, like all other mild hyperbaric products, have not been verified or endorsed by Health Canada or any official government health agencies the Food and Drug Administration (FDA). The information published by the manufacturer of the Oxynova® pressurized chambers is not intended to assign a diagnosis or offer medical treatment. Anyone who wants to start a treatment to prevent or cure an illness or health condition should first consult with a health professional (doctor, nurse, psychiatrist, etc.). The manufacturer of Oxynova® products rejects any claim, directly or indirectly, to improve a health condition.

This device is intended to be used with ambient air only. The buyer releases totally and completely Oxynova® any responsibility for the purchase or use of any of its devices.

© 2021, Oxynova®.

Thank you for choosing
an Oxynova® Mild Hyperbaric Chamber.

To ensure you get the most effective and the longest life of your Oxynova® pressurized chamber, the Oxynova® team invites you to carefully read and understand this user manual.

The Oxynova® soft hyperbaric chambers are sealed technical infrastructures in which you breathe oxygen under pressure of maximum 1.4 ATA in order to facilitate the delivery of extra oxygen for therapeutic, wellness, and sports recovery purposes.

We aim to develop a hyperbaric chamber system that not only is simple to set up and operate, but that can deliver efficient results for each user. Our priority is to build safe, user-friendly inflatable hyperbaric chambers designed to be transportable and easily operated from the outside and the inside without any assistance. Our chambers are safe and reliable for intensive use, as well as cost-efficient.

Oxynova® chambers undergo a multi-stage inspection at all production stages, from manufacturing and assembly to shipping and maintenance to ensure our customers safety and satisfaction.

Each seam, seal, and window is “stress-tested” at a higher pressure to greatly exceed any safety standards. A “burst” test on randomly selected chambers during production is part of strict quality and safety control procedures.

Oxynova® offers the possibility of choosing your own setup, according to your needs. The additional pass-through, depending on the selected Oxynova® model, is generally used for the installation of optional equipment, such as a LED lighting system, audio headphone jacks, communication systems, oxygen delivery, etc.

These instructions are written for the following devices:

	<i>1.4 ATA Pressure</i>	<i>Ø 56 x L 228 cm</i>
	<i>1.4 ATA Pressure</i>	<i>Ø 72 x L 235 cm</i>
	<i>1.3 ATA Pressure</i>	<i>Ø 84 x L 242 cm</i>
	<i>1.3 ATA Pressure</i>	<i>Ø 92 x L 284 cm</i>



*Electric Shock Hazard.
Cabinet to be removed by authorised personnel only.*





*Electric Shock Hazard.
Cabinet to be removed by authorised personnel only.*



General warning. This symbol is used throughout this manual to indicate hazardous situations

2.1 ▪ Warnings

 **WARNING** *If the user does not follow the instructions contained in this manual, the resulting actions could damage the chamber and/or cause injury to one or more individuals. In the event that a user of an Oxynova® Hyperbaric Chamber does not comply with the instructions provided by the manufacturer, the accessories or damaged materials will not be covered by the Oxynova® Lifetime Warranty.*

 **WARNING** *Oxynova® units must not be used for or with any life supporting applications. Geriatric, pediatric, or any other patients unable to communicate discomfort while using this machine may require additional monitoring. Advise patients to immediately notify their Equipment Providers and/or physicians in case of any alarming symptoms or discomfort.*

This instruction guide will acquaint you with your Oxynova® hyperbaric chamber. Make sure that you read and understand this guide before operating your unit. Important safeguards are indicated throughout this guide. Pay special attention to all safety information. Contact your Oxynova® equipment provider should you have any questions.

As you read the manual, pay special attention to the **WARNING**, **CAUTION**, and **NOTE** messages. They identify safety guidelines or other important information as follows:

 **WARNING** *Describes a hazard or unsafe practice that can result in severe bodily injury or death.*

CAUTION!

Describes a hazard or unsafe practice that can result in minor bodily injury or property damage.

NOTE

Describes a hazard or unsafe practice that can result in minor bodily injury or property damage.

Location of the device

Position your unit on a flat surface at least 6 inches (16 cm) from walls, draperies or any other objects that might prevent the proper flow of air in and out of your air compressor. The hyperbaric chamber should be located in a well-ventilated area to avoid pollutants or fumes .

Feed air/ambient air quality:

Hot, humid, dirty, oily air deteriorates and degrades the performance of air filters. In order to preserve the effectiveness and extend the lifetime of your Oxynova® chambers, precautions must be taken to ensure that the air provided is cool, dry, clean, and oil-free. The room should also be free of toxic gases and high concentrations of hydrocarbons, especially carbon monoxide. Humid installation areas should be avoided as much as possible.

Relative humidity

8% - 10%, non-condensing

NOTE

Hanging the air filter is a simple and easy way to protect the unit. It is advisable to operate the unit in an air-conditioned or well-ventilated area.

Ambient Air Temperature:

The Oxynova® chambers are designed for use at an ambient temperature range between 15°C to 30°C.

CAUTION!

Operation outside of this temperature range could cause unacceptable risks.

Electrical Power

The power for the control circuitry of the Oxynova air compressor is in accordance with the electrical supply related to your country.

Sound Level

Less than 60 dB (A)

<i>Motor Voltage</i>	<i>HP</i>	<i>KV</i>	<i>KV</i>
110-115 / 220-240	1/4	0.18	800 W, Internationally compatible

Positioning

Ensure the air inlet and outlet on both the compressor and the chamber are not obstructed during use. Ensure the hose is free of kinks and sharp bents.

4

Product description

The equipment and materials in your chamber may vary depending on:

- The model purchased
- The articles and accessories ordered
- The availability of said articles
- The country in which the buyer is located

Please refer to your detailed invoice for your complete purchase details. The manufacturer of Oxynova® products reserves the right to change the appearance of its products, their technical characteristics, as well as the equipment provided without notice.

NOTE

If you are using an older version of Oxynova®, some equipment and accessories in your hyperbaric system may differ from those in this user guide.

5 Components

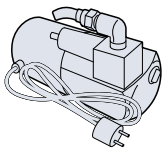

1

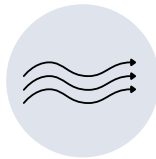

2

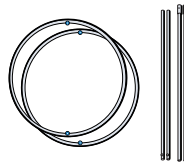

3

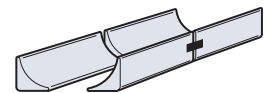

4



5



6

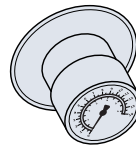

7



8

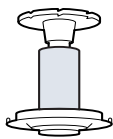

9



10

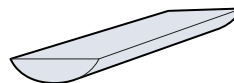

11



12

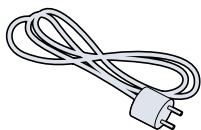

13

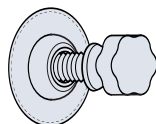

14

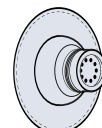

15

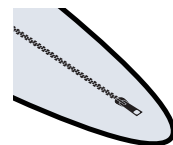

16

Although the Oxynova® hyperbaric chamber models have different dimensions, the essential components required for performance and safety remain the same and are described below.

1	AIR COMPRESSOR	Ultra high flow
2	AIR VOLUME DELIVERY	160 L/min at working pressure (we are the only ones to provide the working pressure flow)
3	INTENAL FRAME	100% stainless steel framework, with quick-connections doesn't require tools for assembly. Available only for the Series 7, 8 and 9
4	BOLSTER	Two full length extra-rigid stabilizers
5	CARRY BAG	Custom designed, double-layered polyester
6	COVER ASSEMBLY	Adds a layer of structure to the bladder (unique to our products); easy to clean and water repellent
7	EXTERIOR & INTERIOR GAUGE	100% stainless steel
8	FABRIC (BLADDER)	PVDF Teflon no off gassing toxicity; welded assembly with unique reinforcement tape
9	FILTRATION	5-micron filter
10	HOSE	Laboratory-grade 9ft (2.5 m) hose, with reinforced nylon sheath
11	MATTRESS	Top-of-the line orthopedic mattress, phthalate free cover
12	OXYGEN ADAPTOR	Single adaptor
13	POWER	800 W, Internationally compatible
14	EXTERIOR & INTERIOR CONTROLLER	bi-directional pressure adjustment handle
15	SAFETY FEATURE	2 tamper-proof pressure relief valves (pat. pend.),
16	ZIPPER	2 custom-made, heavy duty zippers

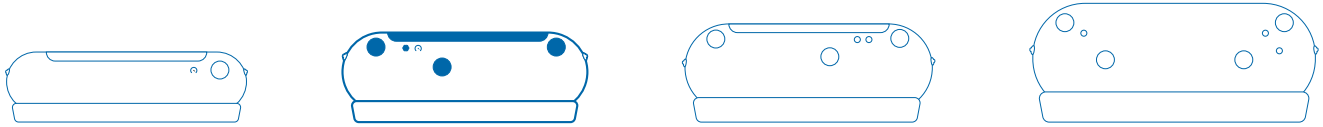

The Oxynova[®] 7 Series Hyperbaric Chamber is our most popular and versatile 1.4 ATA chamber.

Accessible hyperbaric technology designed for personal use to facilitate recovery in the comfort of your home.

Compact on the outside and projecting the image of elegance, this model is ideal for your use at home, on the road, or on a trip. Its numerous features and high-end manufacturing processes will give you the best hyperbaric experience ever.

Very spacious and comfortable, the OxyNova 7 paves the way for in-home mild HBOT in order to help users expedite healing and regain the quality of life.

Internal Frame and Assembly

Our Oxynova[®] hyperbarics are designed with a stainless steel frame and a quick connecting system. Furthermore, they can be assembled without any tools.



Oxynova[®] 7 Special features

DIAMETER	Ø 72 (28 inches)
LENGTH	L 229 cm (90 inches)
WEIGHT	14.5 kg / 31,9 lbs
WINDOWS	8 double layered 5 ½" (14-cm) windows
WORKING PRESSURE	1.4 ATA (0.4 bar / 40 kPa / 5.7 psi)
PASS-THROUGH FITTINGS	8 custom-interchangeable positions (unique to our product, pat. pend.) with dimmable LED lighting
ZIPPER	2 custom-made, heavy duty zippers

5.2 ▪ Central body of the chamber

5.2.1. Chamber main body

The textile of the chamber is made from thermoplastic polymer fiber. This type of material is extremely durable and resistant to chemicals and ultraviolet light. It also has good mechanical properties and high thermal stability.

The Oxynova® exclusive double welding process creates maximum reinforcement and durability, unequaled against the effects of repeated inflation/deflation cycles. Its double or triple integrated system zipper also accentuates mechanical stability.

A special coating on the inner surface of the chamber, exclusive to Oxynova® chambers, eliminates off-gassing (formaldehydes and other plasticizers) usually found in soft chambers.

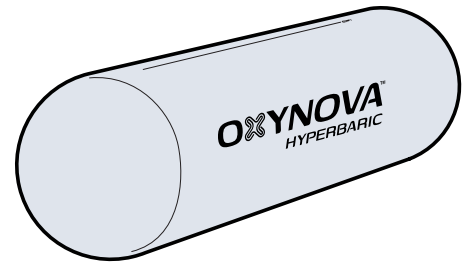

5.2.2. Windows

Based on which Oxynova® hyperbaric chamber you have, there are three to ten transparent windows of a diameter of 5 ½” (140mm) per unit. These numerous windows allow you to keep an eye on the environment, increase the inner brightness of the chamber and, at the same time, decrease the claustrophobic feeling some people might feel.

To ensure maximum safety, the windows have a double or triple thickness, depending on the chamber model (double for Series 5-7-8 and Triple Series 9).

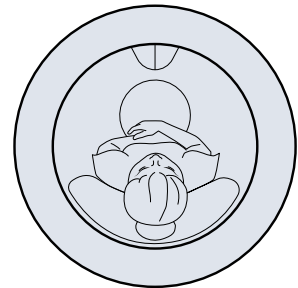

5.2.3. Pressure gauge (manometer)

Each chamber is equipped with at least one high quality and high precision pressure gauge. Made from 100% stainless steel, they indicate the pressure reached in the chamber. The user can easily follow the pressure whether during the compression or decompression phase. By observing the pressure gauge, it is simple to estimate the time required to smoothly reach the desired pressure in order to avoid any risk of discomfort and/or accident.

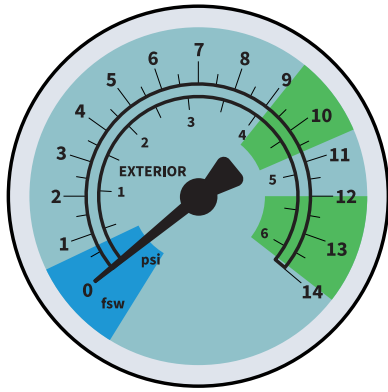

Exterior pressure gauge

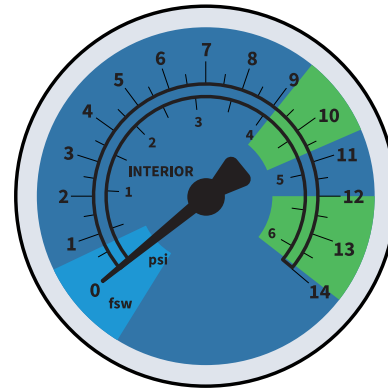

Interior pressure gauge

5.2.4. Pressure gauge reading

The pressure gauge reading will be different depending on the chamber model owned. There are two main indicators on the dial of the gauge. On the exterior of the dial, in blue, the graduation is in Feet of SeaWater (FSW). This measurement indicates the simulated depth of a dive in feet. On the interior of the dial, in red, the graduation is in Pounds per Square Inch (PSI).

Series 5 and Series 7 (1.4ATA)

The pressure is reached when the needle of the pressure gauge indicates **11.9 to 14 FSW or 5.3 to 6.2 psi (green zone)**. If the needle passes the green zone and goes into the red zone, turn off the compressor, stop using the device and notify your Oxynova® representative as soon as possible.

Series 8 and Series 9 (1.3ATA)

The pressure is reached when the needle of the pressure gauge indicates 9.3 to 10.8 FSW or 4.1 to 4.7 psi (green zone). If the needle passes the green zone and goes into the red zone, turn off the compressor, stop using the device and notify your Oxynova® representative as soon as possible.

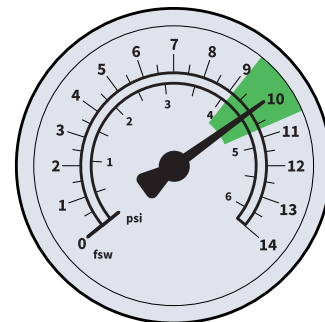
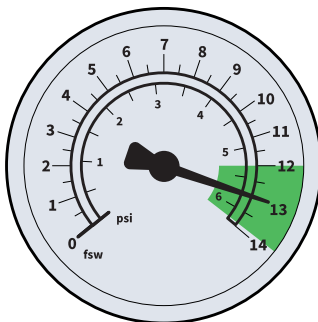

5.2.5. Airtight zipper system

At the other end of the hyperbaric chamber, there are two vents to evacuate the air. In those vents, two pre-set pressure release valves are enclosed.

These valves are volumetric and progressive (PID type), so that they will slowly open to regulate the pressure up to their preset point at around 3 psi (pounds per square inch).

These valves never need adjustment and ensure a good air flow from head to toes.

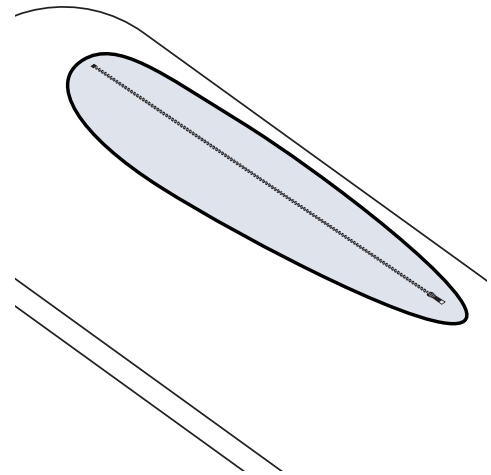

5.2.6 Valve (handle) for pressurization/depressurization

The pressurization / depressurization valve is located on top of the chamber's main body, near the pressure gauge. This handle is extended and can be used from the outside as well as from the inside. During pressurization, the user will be able to regulate (slow down) the pressure increase for maximum comfort. When depressurizing, at the end of the session, opening the valve slowly to control the depressurization curve allows the user to go back comfortably at ambient air pressure. This high precision machined valve needs only to be lightly seated in order to be airtight.

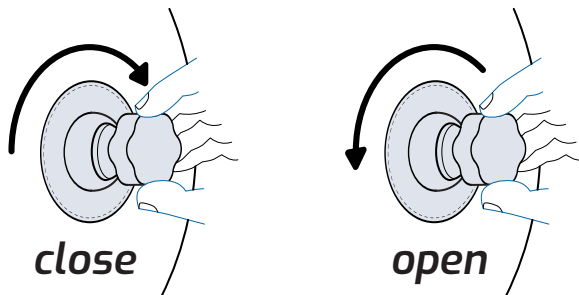

From the inside:

Rotate clockwise in order to open the valve and counterclockwise to close it.

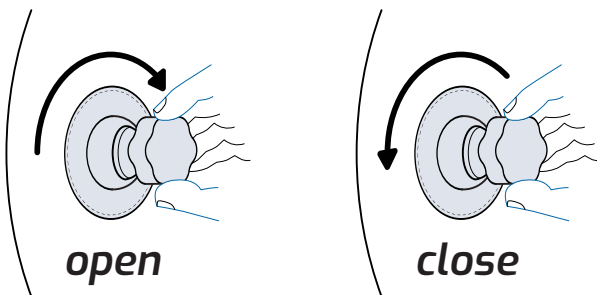

From the outside:

Rotate clockwise to close the valve and counterclockwise to open it.

5.3 ▪ Component sheet (tableau) Components and accessories

Component	OXYNOVA [®] 5 HYPERBARIC	OXYNOVA [®] 7 HYPERBARIC	OXYNOVA [®] 8 HYPERBARIC	OXYNOVA [®] 9 HYPERBARIC
Compressor	1	1	1	1
Chamber	1	1	1	1
Bolster	4 with velcro ties	4 with velcro ties	4 with velcro ties	4 with velcro ties
Matress	1	1	1	1
Hose	1	1	1	1
Pressure Gauge	2 (1 internal, 1 external)	2 (1 internal, 1 external)	2 (1 internal, 1 external)	2 (1 internal, 1 external)
Frame	none	2 rings, 4 straight bars	2 rings, 4 straight bars	4 rings, 8 straight bars

5.3.1 Transport bag

A durable fabric carrying bag is offered with the purchase of each Oxynova[®] chamber. You can fit the chamber, frame, hose, and pressure gauge(s) in it.



5.3.2 Compressor, connecting hose and connectors

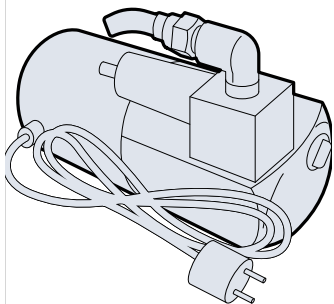

A compressor and accessory connectors are provided with the purchase of an Oxynova[®] pressure chamber. A 10-foot laboratory grade (higher grade than medical grade) hose connects the compressor to the hyperbaric chamber preventing the release of any harmful gas and therefore providing a pure and odorless ambient air. This compressor is especially made for Oxynova[®] Mild Hyperbaric Chambers. It is designed to be used only with ambient air.

Product use criteria:

- Pump only clean, dry air;
- Operate at 59°F - 86°F (15°C - 30°C);
- Protect unit from dirt & moisture;
- Do not pump flammable or explosive gases or use in an atmosphere that contains such gases;
- Protect all surrounding items from exhaust air. This exhaust air can become very hot.
- Corrosive gases and particulate material will damage the unit. Water vapor, oil-based contaminants or other liquids must be filtered out;
- Consult your Oxynova® distributor before using it at high altitude;
- Oil-less rotary-vanes require NO lubrication.

Installation



WARNING:

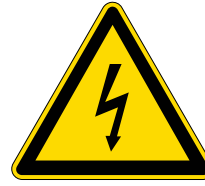

Electrical Shock Hazard

- Install this product where it will not come in contact with water or other liquids;
- Install this product where it will be weather protected;
- Electrically ground this product;
- Failure to follow these instructions can result in death, fire or electrical shock.

CAUTION!

Correct installation is your responsibility. Make sure you have the proper installation conditions and that installation clearances do not block airflow.

CAUTION!

Blocking the airflow of the compressor in any way can cause the air compressor to overheat.



WARNING

Air compressor's surfaces becomes very hot during the operation, **allow compressor's to cool before handling.**



WARNING

Do not inflate the chamber with pure oxygen or with an oxygen concentrator. Doing so will void the lifetime warranty.

CAUTION!

Do not replace the compressor with another model of compressor. Doing so will void the lifetime warranty.

NOTE

Several manufacturers use pistons or diaphragm compressors that cause a peristaltic effect inside the chamber which causes some discomfort, or even, for some users, the need to use hearing protection to mitigate the effects. Furthermore, these pumps lose a lot of air flow when reaching their working pressure, which can cause stagnation of air in the chamber. The high-end Oxynova® compressor is a rotary vane type, which eliminates this effect. Additionally, this powerful compressor provides a high airflow at its working pressure, eliminating the risk of a decrease in oxygen levels and an increase in carbon dioxide levels in the chamber.

5.3.3 Internal mattress

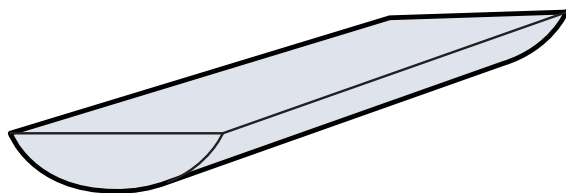

The contoured mattress, adjusted to the inner shape of the chamber, is composed of antiallergenic, high density and anti-dust mite urethane foam. A layer of medical memory foam adds to the overall comfort. This orthopedic mattress is also covered with an antimicrobial fabric that can be disinfected and sanitized.

5.3.5 External stabilizers (bolsters)

Four exterior bolsters cushions are included with each chamber. Equipped with an adjustable Velcro system, these custom formed bolsters prevent the chamber from rolling from side to side. These items are light and easy to install or remove.

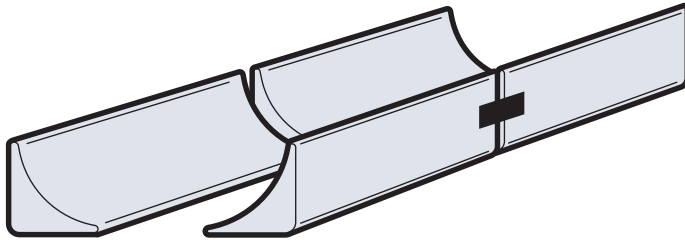

5.3.6 Outer cover



The cover used by Oxynova® adds strength to the structure of the chamber and protects against abrasions. The cover perfectly matches the curves of the chamber and its different components. It has a stain guard coating so only a damp cloth can clean it correctly.

For more information on cleaning, please refer to section 10.

5.3.7 Additional chamber pass-through

The additional chamber pass-through, depending on the selected Oxynova® hyperbaric chamber model, are used, among other things, for the installation of optional equipment, such as a LED lighting system, audio headphone jacks, communication systems, etc.

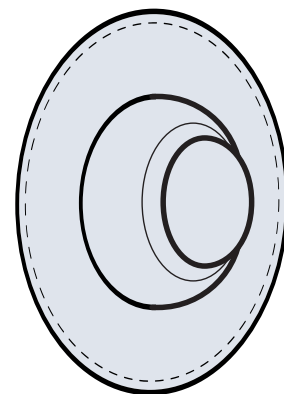

5.4 ▪ *Optional Equipment*

5.4.1 "ICE PACK" air cooler

The Ice Pack air cooler is installed between the compressor and the chamber using the quick connections. The latter includes a large cooler in which a long pipe is disposed of. The air coming from the compressor goes through this pipe before being sent to the hyperbaric chamber. This cooler also includes a special filter to ensure the quality of the air (without odor or water condensation). You must add ice cubes and cold water in the cooler so that it is operational.

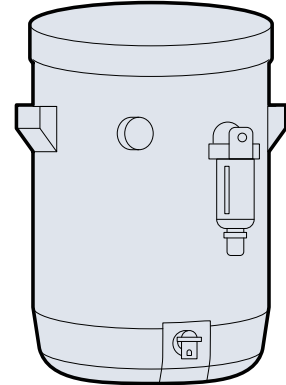

6

Installation and Assembly

It is advisable to install the chamber in a cool and well ventilated place.

The air pushed inside is warmer than the ambient air because of the heat generated by the compressor and because of the increased pressure in the chamber. The temperature inside the pressurized chamber can be 5°C to 10°C higher than outside, especially during the compression period.

If you have trouble setting up your chamber, technical assistance is provided by the chamber vendor or by an Oxynova® representative. You can contact a representative for support at support@oxynova.com. It is advisable to attach photos and give as many pertinent details as possible to your support requests in order to help the technician understand your problem.

6.1 ▪ Assembly of the chamber and initial pressurization

Make sure the assembly is done in a safe environment. The assembly of an Oxynova® flexible hyperbaric chamber can be done alone if the installer has optimal motor capacities. If you have trouble bending over, do not hesitate to ask someone else's help to install your chamber.

NOTE: *Several manufacturers use pistons or diaphragm compressors that cause a peristaltic effect inside the chamber which causes some discomfort, or even, for some users, the need to use hearing protection to mitigate the effects. Furthermore, these pumps lose a lot of air flow when reaching their working pressure, which can cause stagnation of air in the chamber. The high-end Oxynova® compressor is a rotary vane type, which eliminates this effect. Additionally, this powerful compressor provides a high airflow at its working pressure, eliminating the risk of a decrease in oxygen levels and an increase in carbon dioxide levels in the chamber.*

Step 1: Laying the stabilizers

Lay the stabilizers (4 black bolsters) where you chose to install your chamber. You can adjust the space between the Velcro correctly at the end of the installation, when the chamber is pressurized.

Step 2: Laying out all components

Unpack the contents of the carrying bag and compressor box. Make sure all parts are there.

Step 3: Installing the compressor

Unpack the compressor and install it in a well ventilated area. Make sure the air circulates freely around the compressor. Having at least two feet (60cm) of clearance around the compressor is recommended. The compressor is heavy and generates heat. Position it securely out of the way of people and animals. Remove the transport straps as they are blocking the compressor's cooling system. Remove the orange plastic plug from the compressor's inlet and screw (hand-tighten only) the metallic air filter. Remove the tape from the compressor's outlet and screw (hand-tighten only) the white elbow fitting.



WARNING

*It is very important to **remove the transport black straps around the compressor**, otherwise it will overheat the compressor and the atmosphere inside the hyperbaric chamber.*

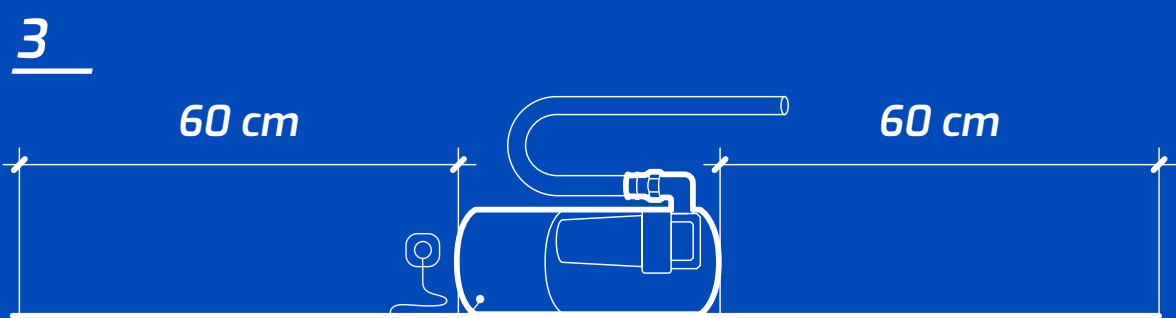
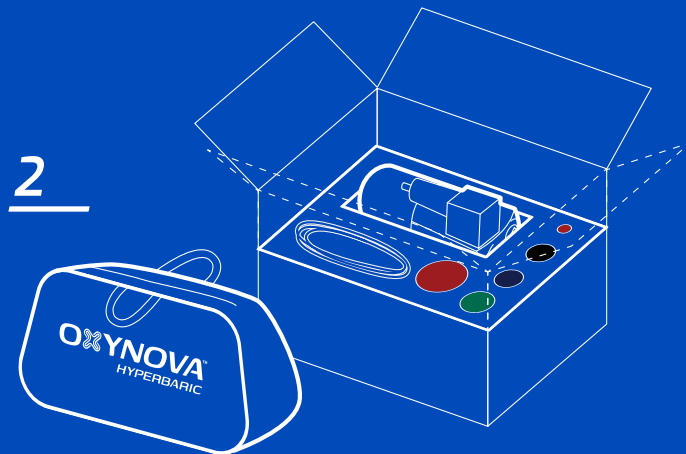
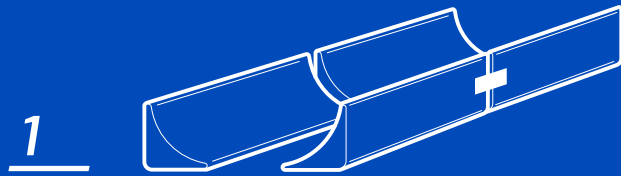

Step 4: Connecting the air supply

Connect the air supply hose to the matching coupler on the compressor and the chamber. Make sure to hear the clicking sound and confirm it is secured.

Step 5: Connecting the compressor

Plug the compressor in a matching electrical outlet to start it. Verify that the zippers are closed and that the Depressurization Valve is seated (see section 2.2.5 for Depressurization Valve manipulation).

You may screw the exterior pressure gauge in the matching hole besides the Depressurization Valve (hand-tighten only). The chamber should inflate and reach its pressure in less than 10 minutes.

If complete pressurization cannot be attained, most of the time it is because the seal between the zippers is not seated correctly. A “massage” along the zipper and/or a pressure where the air leak is felt will resolve the issue. If not, please contact your Oxynova® representative.

Step 6

While the chamber is inflated, you may adjust the bolsters for a good fit and center the bottom of the chamber on the floor.

4

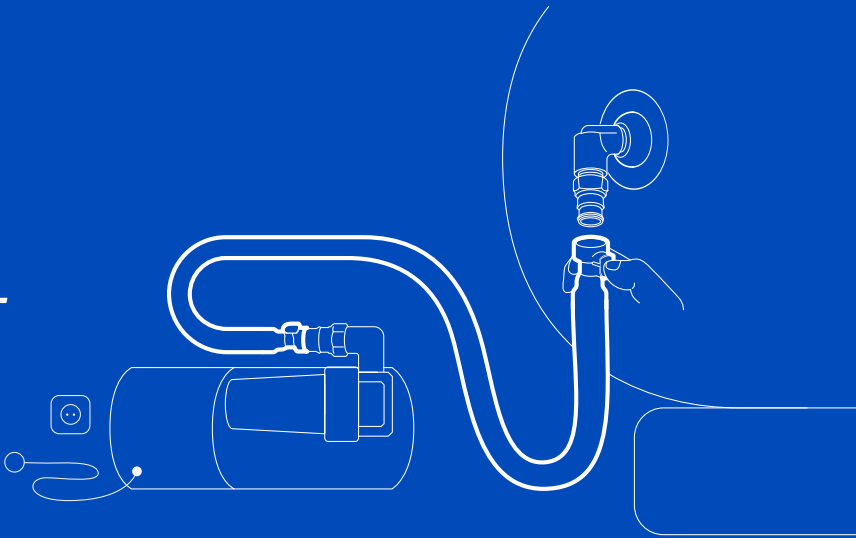

5

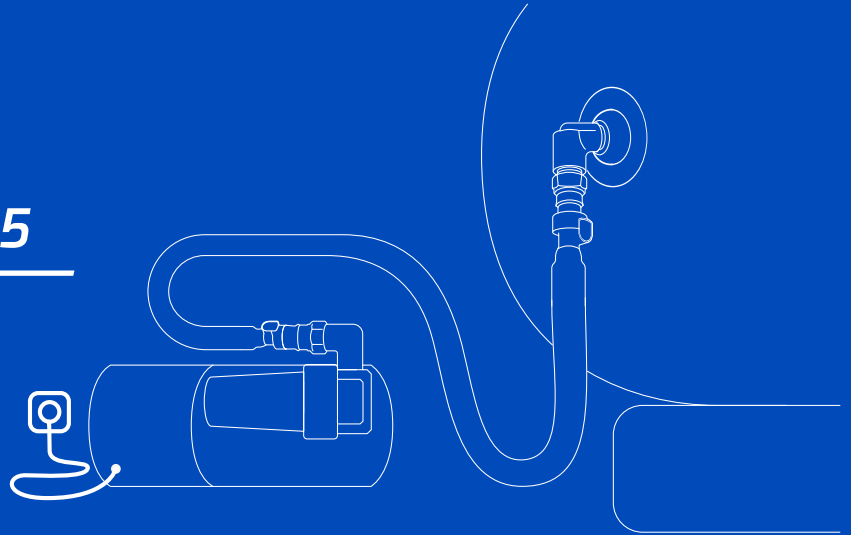

6

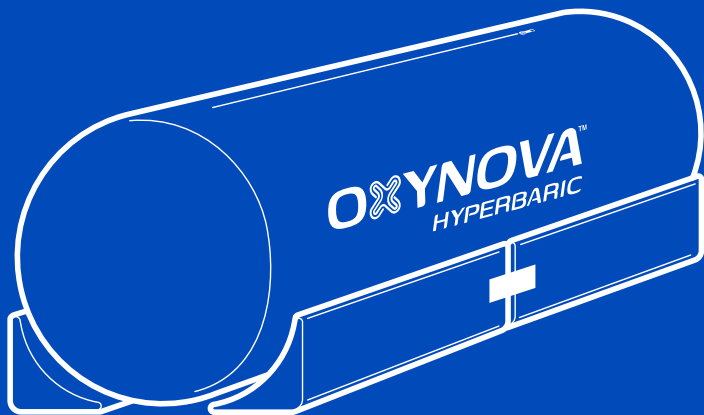

Step 7

Open the Depressurization Valve and wait until the chamber is completely depressurized (the walls of the chamber will become soft). Open the zippers to install the frame.

For  **&** 

Insert one frame ring at each end of the chamber, placing the sockets horizontally. Install the male end of the straight tubes in the ring sockets and then connect the straight tubes together.

For 

Connect one 2 sockets ring with one 4 sockets ring using the short straight tubes. Install the ring pair with the curved ring at the head of the chamber (where the white handle is) with the curved ring at the top and towards the center of the chamber. Install the round pair making sure the 4 sockets ring is toward the center of the chamber. Install the straight tubes in the ring sockets and then connect the straight tubes together.

Ensure connections are secure at all points. The transverse rod on the side serves as an entry point and should be under the level of the windows in order to facilitate the entrance in the chamber.

Step 8: Place the mattress

Make sure the seam at the bottom of the chamber is centered on the floor and then move the straight tube frame so it doesn't touch the white plastic adapters and windows. Fold the mattress in two so that the rounded parts are facing each other. Insert it in the chamber and let it unfold.

Step 9: Install the pressure gauge

You may install the exterior pressure gauge in the pass-through fitting beside the depressurization valve if it was not already done. Install the optional interior pressure gauge if you have it. In order to install it, you have to unscrew the black insert on the opposite side of the exterior gauge pass-through fitting. You may have to use a coin or a flat screwdriver to remove it.

7

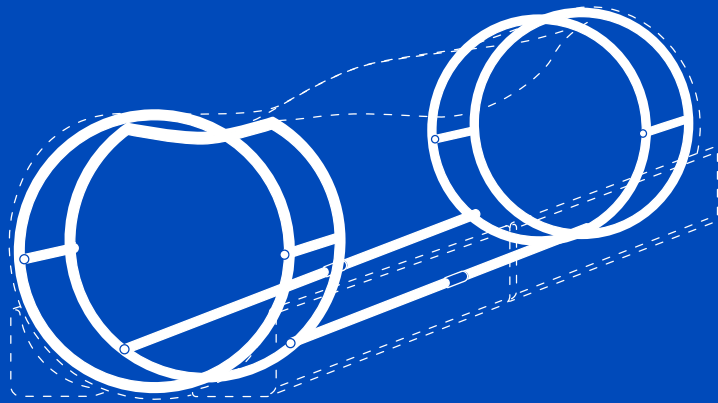
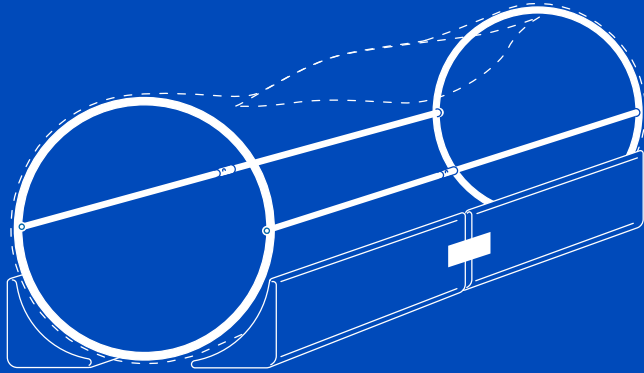

8

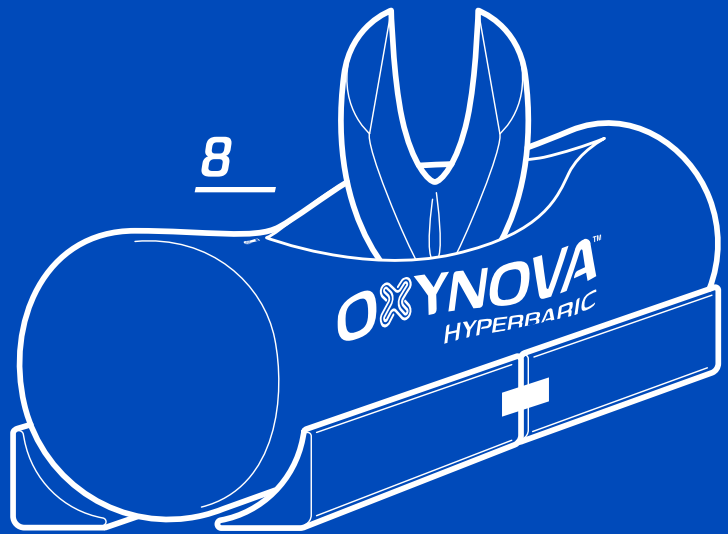

9

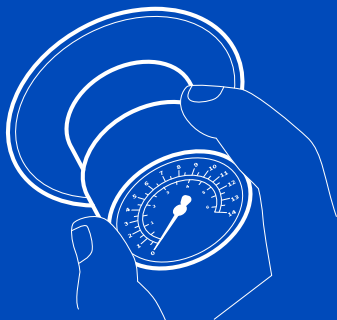

6.2 ▪ Final pressurization test of the chamber

Before using the chamber this second pressurization test will familiarize you with the manipulations of both the closing system and the valve:

- A /** Close the handle completely (clockwise, until seated, no need to tighten the handle);
- B /** Close the two zippers making certain to position the sealing membrane so it is free of any kinks. If the membrane is poorly positioned, there will be an air leak in the chamber and it will not reach the desired pressure.
- B.1 /** Close the interior zipper (furthest from you);
 - B.2 /** Close the second zipper while placing the red membrane evenly along the length.
- C /** Plug the compressor into an electrical outlet. The chamber will inflate slowly for 6 to 8 minutes. As soon as it becomes firmer, you can verify if it still sits correctly on its stabilizers (adjust the stabilizers Velcro if necessary) and center it at its desired location. Wait until it reaches its maximum pressure (green zone on the pressure gauge) and make sure it stays there.
- If the chamber does not build up pressure, see **Section 9.2 c)** and **Section 12. Troubleshooting**.
- D /** Deflate the chamber by opening the handle near the pressure gauge and wait until the pressure is at 0. The walls of the chamber will become soft again allowing the zippers to be open.



WARNING

Do not try to open the chamber zippers when it is still pressurized!

- E /** Unplug the compressor's electrical outlet.

You can now use the chamber, no other break-in period is necessary, the special coating of Oxynova® chambers nearly eliminates the thermoplastic residual curing emanations also called "off gassing" which are harmful to health.

7.1 ▪ *Relative contraindications*

As a safety measure, anyone suffering from the following health conditions must not use Oxynova[®] hyperbaric chambers.

- **All problems related to the eardrum, including eardrum tearing;**
- **Pneumothorax;**
- **Acute nasal congestion;**
- **Blocked eustachian tubes (ear);**
- **Internal infection of the ear;**
- **Upper respiratory tract infections or chronic sinusitis;**
- **Seizure disorder;**
- **Acute headaches or flu / cold symptoms;**
- **Otitis or other ear related conditions;**
- **Cough or nasal congestion;**
- **Intense fever;**
- **Intense fatigue;**
- **Headache;**
- **Intense muscular pains;**
- **Chills or hot flash;**
- **Under the influence of alcohol or recreational drugs.**

7.2 ▪ Absolute contraindications

There is currently only one absolute contraindication to hyperbaric oxygen therapy, namely **untreated pneumothorax**.

Placing a patient in a chamber and changing the pressure around them can result in a tension pneumothorax occurring on ascent, which could quickly become life-threatening. Any patient with pneumothorax should have it treated (likely with some form of thoracostomy tube) before hyperbaric oxygen therapy.

CAUTION!

As a safety measure, anyone taking the following medications is required not to use Oxynova® hyperbaric chambers.

7.3 ▪ Contraindicated drugs

(non-exhaustive list, please consult your prescribing physician):

Topamax;

Epival or Depakene;

Citalopram or Celexa;

All anticonvulsants;

Bleomycin;

Cisplatin;

Disulfiram (Antabuse);

**Doxorubicin hydrochloride
(Adriamycin);**

Mafenide Acetate (Sulfamylon).

CAUTION!

*Always consult your healthcare professional before initiating treatment.
Respect and follow your healthcare professional's recommendations before initiating treatment.*

**WARNING**

If you use the chamber for commercial purposes, ensure that a list of contraindications is visually accessible near the chamber.

8**Risks of use**

A significant and probable risk of **otic barotrauma** exists when there is an imbalance of pressure in the tympanic membrane. This can lead to a ruptured eardrum.

Barotrauma can occur during compression and/or decompression phases of the hyperbaric chamber. It is therefore very important to **raise or lower the pressure slowly in a linear fashion and ensure that pressure change remains comfortable.**

The method below helps to overcome this discomfort:

8.1 ▪ Valsalva method

The classic Valsalva maneuver aims to equalize pressure in the eardrums by closing the mouth and exhaling while pinching the nose (**expiration effort forced to glottal closed for a few seconds**).

It is important to only bring back the balance and not anticipate future pressure.

If you feel pain in the eustachian tubes (inner ear, side of throat) or ears, it is better to manually stabilize the pressure of the chamber and allow time to rebalance the pressure in the inner ear. If the pain persists, it is advisable to stop the treatment.

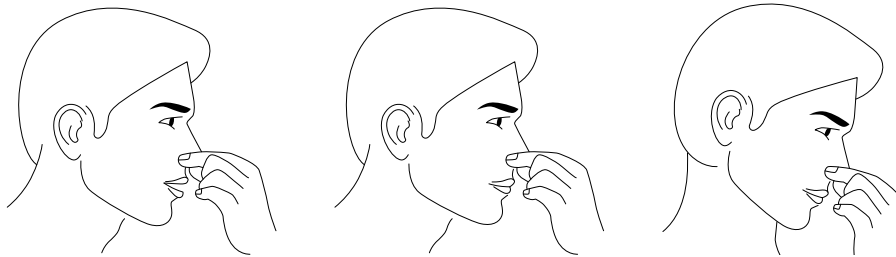

The steps of the Valsalva method in more details:

- 1 / Close your mouth and gently exhale through your nose while pinching it close with your fingers (as if you wanted to slowly blow your nose). It can be done while slightly tilting the head left and right;
- 2 / Swallow your saliva;
- 3 / Yawn;
- 4 / Stretch your eustachian tubes (neck) and massage gently.

CAUTION!

It is important to only balance the pressure!

8.2 ▪ Possible adverse effects and possible complications

Fortunately, with HBOT (hyperbaric oxygen therapy, there are only a few mild and temporary side effects. These may include:

- **Ear and/or lung barotrauma**
(injury caused by heightened air pressure);
- **Temporary changes in vision;**
- **Lightheadedness;**
- **Fatigue;**
- **Low blood sugar.**

Although extremely rare, oxygen toxicity seizures and pressure injury to the lungs can occur in patients with underlying brain or lung disorders.

CAUTION!

Most side effects of HBOT are minor and temporary. If they don't go away, or if they worsen, seek medical attention as soon as possible.

9**Claustrophobia**

Claustrophobia refers to the discomfort or the feeling of being trapped in an enclosed place. It is possible that a hyperbaric chamber treatment triggers the symptoms related to claustrophobia. They can manifest in varying degrees. Nonetheless, it is very important to remain calm. If a treatment has to be stopped because the feeling of claustrophobia is too intense, one must still follow the depressurization procedure correctly.

**WARNING**

In order to limit the risks of otic barotrauma, do not depressurize the chamber faster.

NOTE:

It is quite possible to decrease the feeling of claustrophobia associated with HBOT. It is a matter of going very gradually and staying under the supervision of an attentive and calm attendant.

10.1 ▪ Intended use

Anyone with an optimal health condition and who has no limitation for using a hyperbaric chamber can perform up to two sessions a day without any risks. The increase in pressure inside the chamber results in a change in the oxygen saturation of the blood. As ambient air is pressurized, red blood cells have a greater capacity for oxygen absorption. After a few minutes, the oxygen level in the whole body is increased slightly above normal. The body having more oxygen regenerates faster and decreases healing time. The benefits of this therapy are multiple

**WARNING**

No specialized training is necessary, but the instructions given should be understood and followed in order to operate the chamber safely.

**WARNING**

Children ages eight and up have to be accompanied by an adult in the hyperbaric chamber.

10.1.1. Recommendations before treatment

CAUTION!

It is advised for smokers not to smoke at least two hours before the treatment and two hours after the treatment, otherwise the effect is not as beneficial. Smoking may even negate it.

CAUTION!

It is advised not to drink coffee at least one hour before the treatment.

CAUTION!

It is advised to wear cotton underwear.

CAUTION!

It is advised not to wear makeup or perfume.

10.2 ▪ Wellness and non-medical hyperbaric benefits

An absolute key component of optimal physical and mental health is oxygen, as it:

- **Increases concentration during mental activity;**
- **Reduces stress;**
- **Straightens the immune system;**
- **Promotes new blood vessels growth;**
- **Has a fabulous effect on skin;**
- **Has a positive effect on digestion;**
- **Promotes faster healing of injuries and wounds;**
- **Slows down aging process on cellular level;**
- **Increases stem cells production;**
- **Increases mental clarity and alertness;**
- **Detoxifies cells;**
- **Has a favorable effect on mood;**
- **Has a positive effect on fatigue and relaxation of the mind;**
- **Has a favorable effect on sleep;**
- **Improves poor posture;**
- **Smooths wrinkles and fine lines;**
- **Has a positive effect on joint mobility;**
- **Reduces inflammation and swelling;**
- **Has a positive effect on joint mobility;**
- **Reduces serum lactate accumulation;**
- **Alleviates the peripheral fatigue.**

10.3 ▪ Preparation for a session

Before starting your first hyperbaric session, it is important to become familiar with the Valsalva maneuver. This will allow you to balance the pressure in your ears, especially during pressurization and avoid an otic barotrauma, which is felt by pain in ears and / or eustachian tubes. Here are the steps for the Valsalva maneuver.



WARNING

It is also important to use only a properly grounded electrical outlet. Do not position equipment in such a way that makes it difficult to disconnect the plug from the outlet.

CAUTION!

Make sure the chamber and compressor (transports straps removed) are properly installed, placed in a well-ventilated area and that the hose is well connected. Plug the compressor in a wall outlet.

CAUTION!

It is important to only balance the pressure!

Before starting your first hyperbaric session, it is important to become familiar with the **Valsalva maneuver (section 8.1)**.

Be familiar with the manipulation of the handle to control the air pressure rates.

10.3.1. Average session duration

A session usually lasts **45 to 90 minutes**, depending on your health goals and the protocol you were advised to use.

10.4 ▪ Things to never take with you in a hyperbaric chamber



Laptop and other electronic devices are not advised due to fire hazards



Food (for sanitary reasons)



Electrical outlet/extension cord since the zippers have to be completely closed



Balls or balloons due to pressure changes



Any pointy and/or sharp objects



Watches or jewellery



Hand warmers



Flame producing devices such as lighters or matches



Cigarettes



Shoes



Anything containing oil, grease or alcohol



Any other items deemed unsafe by the hyperbaric operator



WARNING

It is also important to use only a properly grounded electrical outlet. Do not position equipment in such a way that makes it difficult to disconnect the plug from the outlet.

10.5 ▪ *To do before a session:*

- 1 / Take the time to go to the bathroom;**
- 2 / Bring a bottle of water, drink moderately during the session;**
- 3 / In order to avoid any spark, change clothing made of static-generating fabrics or synthetic fibers to a 100% cotton or any known non-static fabrics;**
- 4 / Take off your shoes. You can keep your socks;**
- 5 / Carry a lightweight blanket for optimal comfort.**

10.5.1 *To be done during a session:*

Allow yourself some rest and indulge in a calm inducing activity such as sleeping, reading a book, meditating, or listening to your favorite music.

The person inside the hyperbaric chamber can easily communicate with an attendant who is outside of the hyperbaric chamber when the latter approaches a window.

10.5.2 *To do after the session:*

After the completion of the treatment in the hyperbaric chamber, the treatment effect continues for approximately six more hours, because of the higher oxygen concentration in the user's body. Feelings of relaxation, concentration, and greater energy as well as a pleasant feeling of tiredness can also be experienced. Effects of the treatment can be seen and felt right away or a day or two after the treatment. The number of necessary treatments may vary from one user to another depending on the reason for the consultation.

NOTE:

It is very important to respect the comfort and limits of the body of the person undergoing the session. If it takes more than 10 minutes to reach the operating pressure there is no problem!

Here are the steps that will be described in more details further:

- 1 / Connect the compressor to the wall socket;
- 2 / Enter the chamber slowly, taking care not to put stress on the zippers and the membrane. Sit in the middle of the chamber so you can have easy access to the zippers and lie down easily;
- 3 / Close the two zippers making sure the sealing membrane is correctly positioned;
- 4 / Adjust the pressurization speed by turning the pressurization/depressurization handle;
- 5 / Perform the Valsalva method (section 8.1) in order to balance the pressure inside the ears.

At the end of the session, during the depressurization, the handle is very slightly opened. Depressurize the chamber over a period of 15 minutes or more (depending on the comfort levels of the user, by always slowly opening the handle a little more.

11.1 ▪ Pressurizing the chamber with a single user operating the chamber from the inside

NOTE:

See section **11.2 Use with an attendant** for use with an attendant outside.

Connect the compressor first. There will be a supply of fresh air during the time that the user installs and closes the slides.

Close the inner and outer slides in steps of 6 to 12 inches (15 to 30 cm) making sure that you level out the membrane between the two slides. **Complete the closing of the outer slide taking care to position the zipper puller flat on the membrane.**

Make sure the membrane is smooth before closing the inner slide. Take care to have the zipper pullers flat to ensure a better seal of the membrane.

The chamber should take 4 minutes to go from 0 to 5 psi, and 5 to 10 minutes to go to 5,7 psi. It is possible that the membrane needs to be placed to begin the pressurization. You might need to “massage” or press the zipper, especially at the ends, in order to flatten and properly seat the membrane. Once the pressurization has started, the membrane will stay sealed.

11.1.1. *Depressurization (deflation)*

During the depressurization of the chamber, one could feel small cracks in the ears. This feeling is similar to what is felt when landing in an airplane. This feeling is normal. Just perform the Valsalva method (**Section 8.1 Valsalva Method**).

If this sensation intensifies and persists, the process of depressurization must be temporarily slowed down or stopped. When the pressure gauge indicates 0 and the walls of the chamber are becoming loose, you can open the zippers.

 **WARNING** *Under no circumstances should you open the zipper when the chamber is pressurized. The closing system may be subject to damage that will not be covered by the warranty.*

11.2 ▪ *Use with an attendant*

 **WARNING** *Make sure the user is apt to go through a hyperbaric session. See section 8.1.1.*

- 1 / Connect the compressor to the wall socket;
- 2 / Make sure to have the least possible stress on the zippers and the membrane as the user enters the chamber. Wait for the user to be comfortably lying in the hyperbaric chamber;
- 3 / Close the two zippers (the inner closure first) making sure that the sealing membrane is correctly positioned. Take care to have the zipper pulls flat to ensure a better seal of the membrane;
- 4 / Adjust the air inlet speed by turning the pressurizing handle clockwise or counterclockwise;
 - Counterclockwise stabilization or lower the pressure
 - Clockwise increase pressure

CAUTION!

At all times, check the comfort of the user inside the chamber.

- 5 / Through a window, remind the user to perform the Valsalva method (Section 8.1) to calibrate the pressure inside his/her ears;
- 6 /
When the pressure gauge needle is in the green section, make sure that the user inside is comfortable (the session is now starting);
- 7 /
At the end of the session, advise the user in the chamber that the depressurization of the chamber will begin;
- 8 / Remain close to the chamber throughout the depressurization.

NOTE:

Be calm and reassuring to reduce the anxiety that can be felt by the user who will perform the session. It may be that the individual is claustrophobic and discovers this fear for the first time when he is in the hyperbaric chamber. If the individual panics, it is important to stay calm and respect a comfortable depressurization

**WARNING**

Under no circumstances should you open the zipper when the chamber is pressurized. The closing system may be subject to damage that will not be covered by the warranty.

11.3 ▪ End of a session (steps)

- 1 / When depressurizing, slightly open the handle. The depressurization of the chamber should last about 15 minutes;
- 2 / Open a little more, but slowly, the handle. Never accelerate the depressurization stage;
- 3 / When the pressure gauge reads 0 psi, make sure that the pressurizing handle is fully open;
- 4 / Once the fabric of the chamber is softened, the zippers can be opened;
- 5 / Help the person to get up and out;
- 6 / Turn off the compressor.

NOTE:

Someone may need to take a moment to find its equilibrium at ambient pressure following a session. Invite the user to sit down until they feel good. You can complete a session log to track the progress of the user conducting the sessions.

CAUTION!

In case of a power failure, the compressor will not work anymore. The chamber will depressurize gently by itself and the person inside will be able to get out. It is important to remain calm, even if the air does not circulate, you have more oxygen than necessary in the chamber to depressurize and get out.

12.1 ▪ Cleaning

Upon delivery, Oxynova® hyperbaric chambers are perfectly **sanitized and ready for use.**

It is advisable to clean the chamber once a week if you are the only user to eliminate bacteria that may develop in this environment. If the chamber is manipulated by several users, cleaning is recommended after each session. Cleaning your chamber ensures you to keep the appliance safe and clean.

In order to clean the device, you must use a mild soap (lists of products to use here below).

- 1 / Apply a mild soap with a towel inside and outside the chamber;
- 2 / Leave the soap and allow it to set for 10 minutes before rinsing;
- 3 / Wipe the soap with another towel that you have moistened with lukewarm water;
- 4 / Ensure that no soap residue remains;
- 5 / Let the chamber air dry.

Lists of safe cleaning products (non-exhaustive list):

- Microfibre washable towel;
- Washable cotton towel;
- Washable cotton towel hypoallergenic;
- Soft soap: Lemieux Pure • Pure - Crockery;
- Satau brand cleaning products.

This list is not complete. These are product proposals that have been deemed safe to perform maintenance of the hyperbaric chamber.

We recommend you to clean the windows every day, if the chamber is used often. The fabric of the cover and the chamber exterior should be cleaned weekly if used frequently.

NOTE:

If a sanitizing agent is used, please make sure it is compatible with the fabric by testing a small area. Make sure to follow the sanitizer's instructions.



WARNING

Please do not use harsh chemicals cleaning agents such as paint thinners or undiluted concentrated soaps. Always try new cleaning products on a small surface before using them.

Never use the following products:

- **Windex**
- **Rain-X**
- **Pledge**
- **Plexus**
- **Simple Green**
- **Orpine**
- **Any other harsh cleaner to clean your chamber and the windows**
- **Car wax**
- **Any other kind of wash and wax products**
- **Cleaners**
- **Polishes**
- **Scratch remover**
- **Any other products intended for commercial grade vinyl or plastic**

12.2 ▪ Compressor maintenance

CAUTION!

The lifetime of any Oxynova® compressor filter is directly related to the air quality that is fed into it.

CAUTION!

Before using the chamber, make sure that the transport belts have been removed from the compressor body.

The compressor filters (pre-filter in the perforated metallic mesh and the cartridge in the transparent housing at the air outlet of the compressor) must be replaced after 200 hours of use.

Depending on the usage, air quality or break-in time of the compressor, the first cartridge set may need to be changed sooner. If the compressor is kept in a dusty environment, the pre-filter can clog faster.

When it is not replaced at the right time, the pre-filter and/or the clogged cartridge can create problems (e.g. the chamber will inflate less quickly, the chamber will not reach its operating pressure, possible overheating and/or compressor failure, etc).

12.2.1. Replacing the pre-filter

The cylindrical pre-filter is simply screwed onto the air intake port of the compressor. Unscrew the old one and screw the new one. No tools are needed for installation, simply screw everything by hand.

12.2.2 Replacing the cartridge

Step 1

To replace the compressor cartridge: It is necessary to lower the gray latch on the side of the tank and to pivot it until its release.

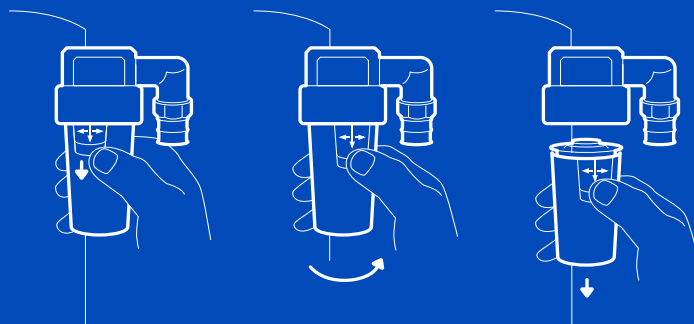

Step 2

Unscrew the special nut holding the cartridge.

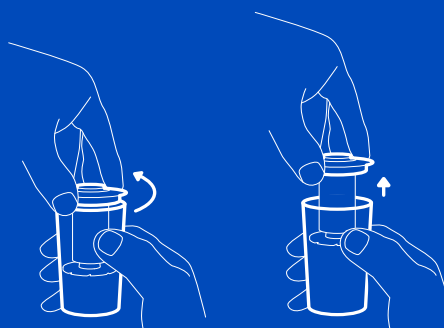

Step 3

Replace the cartridge.

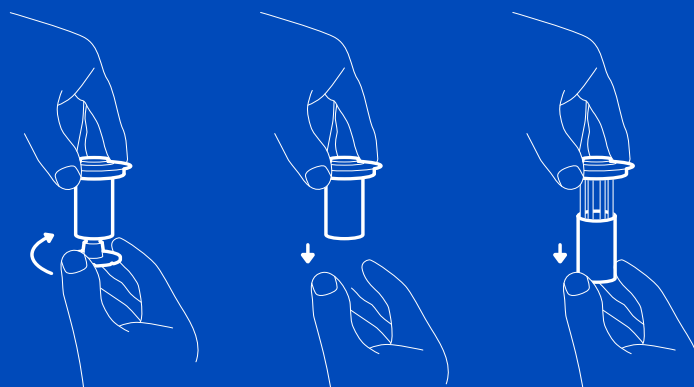

Step 4

Reassemble the reverse of disassembly.

CAUTION!

After 2,000 hours of operation, it is recommended that Oxynova® have a general check of all compressor components.

13

Storage and Transportation

- 1 / Prior to storing the chamber, ensure that it has been cleaned inside and outside by using the recommended solutions (mentioned in the sections 12.1 Cleaning);
- 2 / Disassemble and take out the internal framework, then wrap it with bubble wrap or a similar material;
- 3 / Detach both pressure gauges and the white elbow fitting by scrolling them out, then wrap them with bubble wrap or a similar material before placing them in their box;
- 4 / You can then carefully fold the chamber. Place the chamber in the carry case and store in a dry area between 15°C (59°F) and 30°C (86°F).



WARNING

After a longer non-operation of the device (approximately one (1) month), it is advised to run the device without the occupant and check for proper operation of the device.

CAUTION!

Upon first reuse, run the chamber for several hours to purge the chamber from any odors that may have collected during storage.

CAUTION!

When transporting the hyperbaric system make sure you first protect all parts in separate boxes, wrap everything with bubble wrap or a similar material.

CAUTION!

Damages resulting from transportation of the system are not covered by the Lifetime Warranty.

Problem	Solutions
<ul style="list-style-type: none"> ▪ The chamber has difficulty to pressurize; ▪ A hissing sound is heard; ▪ The chamber does not inflate at all; ▪ Both pressure gauges can't reach the green zone. 	<ul style="list-style-type: none"> ➔ Reposition correctly the sealing membrane; ➔ Make sure the zippers are completely closed; ➔ Make sure the hose is not kinked or has any sharp bends in it; ➔ Make sure the hose quick connectors are securely coupled; ➔ Make sure the compressor runs and the filters are not clogged.
Heat is uncomfortable inside the chamber.	Use an Oxynova® Ice Pack cooler to cool down ambient air which might already be too hot (contact your representative).
Obstruction of the pressure regulating valves.	<ul style="list-style-type: none"> ➔ Remove any foreign object(s); ➔ Remove any foreign object(s); ➔ If nothing is blocking the pressure regulating valves, stop using the chamber and contact your Oxynova® representative.
The pressure gauge goes beyond the green zone and is in the red zone.	Slightly open the depressurization valve to decrease the pressure back in the safe zone.
Inadequate air circulation around the compressor.	Move to a well ventilated area.
Inadequate air circulation around the compressor.	<ul style="list-style-type: none"> ➔ Try another electrical outlet; ➔ The compressor may have overheated, it will resume its function once cooled down. Make sure it is place in a well ventilated area; ➔ Make sure the filters are not clogged; ➔ Contact your representative if the above suggestions did not resolve the situation

Problem**Solutions**

<p>The air flow is too low (inflating takes more than 25 minutes)</p>	<ul style="list-style-type: none">→ Check the outer air inlet filter on the compressor and if necessary clean it or change it;→ Make sure that the Oxynova® chamber inflates with the compressor and is not inflated with oxygen.
<p>Does not reach working pressure</p>	<ul style="list-style-type: none">→ The pressure relief valves on the chamber are open;→ The pressure relief valve inside the chamber is open;→ The zipper is not fastened all the way;→ The pressure relief valve is locked. Check the rubber sealing on the valve piston by slightly moving it with your fingers;→ If none of the above solves the issue and the chamber is not leaking at the described places, it is a malfunction. Stop using the chamber and call repairs/service.
<p>Strong leakage sounds from the device</p>	<p>A failure may have occurred in the interior. Stop using the chamber and call repairs/service.</p>
<p>Pressure gauge does not indicate pressure (the chamber is empty)</p>	<p>There is no pressure in the chamber. The compressor does not work. The hoses are not connected to the chamber and the compressor.</p>
<p>Pressure gauge does not indicate pressure (the chamber is inflating)</p>	<p>Check if there is an obstacle on the inside of the chamber, which is preventing free air flow to the pressure gauge and therefore preventing the pressure gauge from performing the measurement. The pressure gauge is broken. Stop using the chamber and call repairs/service.</p>
<p>The pressure gauge shows higher pressure than is required for the device</p>	<ul style="list-style-type: none">→ Pressure relief valves are not activated.→ Check if there is an obstacle on the inside of the chamber, preventing free flow to the pressure gauge and therefore preventing the pressure gauge from performing the measurement. Move the valve piston with your fingers to establish a free air flow. Immediately manually lower the pressure so it reaches the working pressure and notify repairs/service.
<p>It is not possible to fasten the zipper due to a malfunction</p>	<p>The chamber must not be operated! Call repairs/service.</p>

Problem	Solutions
The chamber moves.	Check if anti-roll bolsters are properly installed.
Air hose on the chamber is pinched due to obstacles.	Deflate the chamber, release the air hose and ensure that it is not caught under the chamber or under the handrail.
The device does not work properly.	Check whether the scheduled service was performed.

Important Notices

- **Regularly inspect seams, fittings, zippers, and welds to ensure the good mechanical strength of the chamber;**
- **Keep the chamber clean;**
- **Do not use enriched or pure oxygen to inflate the chamber: fire or explosion may occur;**
- **Do not replace the compressor by any other model or type of compressor. The chamber is designed to work with this specific compressor. Changing the compressor model or type will void the warranty;**
- **To avoid the risk of electric shock and failure, do not install the compressor near water (bath, pool, rain exposition, etc.);**
- **Ensure the chamber and its accessories have enough distance from sources of heat (light bulbs, heaters, etc.);**
- **Ensure the hose between the compressor and the chamber has no kinks;**
- **Ensure the chamber is placed on a flat surface that is large enough to prevent roll off and falls;**
- **Do not attempt any repair on the chamber by yourself: it will void the warranty.**

FDA 510K Clearance

Mild hyperbaric chambers, Class II Medical Devices, have been cleared by the FDA for the treatment of Acute High Altitude Sickness.

Attendant checklist for attending hyperbaric therapy

Patient Intake Form

I, the undersigned, confirm that the data entered is correct. I agree that the data will be used only for internal purposes of _____ (company or operator name).

Any freely given, specific, informed and unambiguous indication of the data subject's wishes by which he or she, by a statement or by a clear affirmative action, signifies agreement to the processing of personal data relating to him or her .

I am aware that hyperbaric therapy represents a complementary, non-medical treatment, and does not surrogate any medical therapy. Always consult with your healthcare supervisor before starting any treatment protocol in the Oxynova® hyperbaric chamber . If you experience any pain or difficulty with this type of therapy, stop and consult your healthcare provider.

First Name

Last Name

Sex

Date of birth

Address

City

State

Zip Code

Phone

Email

Married

Widow

Separated

Single

Divorced

Other

How did you hear about us?

Are you familiar with Hyperbaric Oxygen Therapy?

What is the level of your health?

Excellent

Good

Fair

Poor

Patient Intake Form

Please list your most concerning health care problems at this time (in order of importance to you)

1 / _____
2 / _____
3 / _____
4 / _____
5 / _____

The purpose of this health questionnaire is to find out if you need a medical examination before a hyperbaric treatment.

Please respond to the following questions by placing a check mark (✓) in the answer box that corresponds to your response and/or fill in the blank where indicated.

In case they answer one or more of the answers in this questionnaire in the affirmative, the attendant must consult with a medical practitioner and gain a medical certificate regarding the suitability of hyperbaric treatment before attending the treatment.

Are you currently on any contraindicated drugs?

- | | | |
|---|--|---|
| <input type="checkbox"/> Topamax | <input type="checkbox"/> All anticonvulsants | <input type="checkbox"/> Disulfiram (Antabuse) |
| <input type="checkbox"/> Epival or Depakene | <input type="checkbox"/> Bleomycin | <input type="checkbox"/> Doxorubicin hydrochloride (Adriamycin) |
| <input type="checkbox"/> Citalopram or celexa | <input type="checkbox"/> Cisplatin | <input type="checkbox"/> Mafenide Acetate (Sulfamylon) |

I declare that the information provided about my medical status is accurate and that I will inform the clinic/center or operator of any changes in my medical condition.

Date _____

Signature _____

Signature of parent or guardian if underage:

APPENDIX II

Hyperbaric treatment log

First & last name _____

Date of birth _____

occupant counseling

pre-breathing check

attire check

complete

Date	Therapy time (min)	Number of minutes	At pressure	Pressure (bar)

Operator	Before therapy:
Notes	During therapy: After therapy:
Operator	Before therapy:
Notes	During therapy: After therapy:
Operator	Before therapy:
Notes	During therapy: After therapy:
Notes	Before therapy:
Notes	During therapy: After therapy:

APPENDIX III

Lifetime Warranty Certificate

Oxynova® Hyperbaric declares that the appliance will operate **faultlessly** in the warranty period, provided it will be used in accordance with its intended use and the Operator's manual.

Warranty is only valid if all conditions mentioned in the **Lifetime Warranty Statement** are fully respected. For repairs, contact the local representative of Oxynova® Hyperbarics.

Hyperbaric chamber:

Model

Serial number

Vendor (Reseller, or Distributor)

Country

Date of acquisition

Signature

Manufacturer: INO Science Inc., 1-120 Oliva-Turgeon, Sherbrooke, J1C 0R3, Qc, Canada

Lifetime Warranty Statement

Oxynova warrants that the manufactured products will be **free from defects** in materials and workmanship.

The lifetime limited warranty term begins on the date of the product purchase as described in the following text. Please note that shipping and regular maintenance costs are not covered by the warranty and are to the owner's expense. Oxynova will repair or replace the defective product at its discretion.

This Limited Warranty is issued to the named person(s), or company as provided by the mandatory end user registration and is transferable between users pending registration of product(s) with an Oxynova authorized dealer or on Oxynova's website. Calibration, inception, and update servicing must be performed annually or this warranty becomes void.

This limited warranty covers:

- Defects in materials and craftsmanship on the bladder, and its components;
- Defects in materials and craftsmanship on the cover and its components;
- Defects in materials and craftsmanship on the stainless steel tubular frame;
- Defects in materials and craftsmanship on the mattress cover and foam;
- Defects in materials and craftsmanship on the compressor and its components;
- Defects in materials and craftsmanship on the pass-through fittings.

This limited warranty does not cover or will become void if:

- Normal wear and tear of the system;
- Consumable parts such as air filters;
- Any items that are in one or more of the following categories: damage due to shipping; accessories or parts added to an Oxynova system after the system is shipped from Oxynova or an authorized dealer, agent and/or representative;
- Products purchased through unauthorized Oxynova dealers, agents and/or representatives;
- External accessories or components or parts that are not branded or included in Oxynova's standard price list/catalog;
- Cosmetic damage including, but not limited to, scratches and tears (unless failure has occurred due to a defect in materials or workmanship).

This limited warranty covers:

- Damage is caused by accident, abuse, misuse, fire, liquid contact, earthquake, or other external cause;
- Damage is caused by service including upgrades performed by anyone who is not a representative of Oxynova or an Oxynova Authorized Service Provider;
- An Oxynova Product has been modified to alter functionality or capability without the written permission of Oxynova;
- The serial number has been removed or defaced; or if Oxynova receives information from relevant public authorities that the product has been stolen or if you cannot prove in any way that you are the authorized user of the product (e.g. by presenting proof of purchase);
- Damage is caused due to the chamber placed too close from a source of heat;
- Damage is caused due to cleaning with harsh chemicals, for example, acetone or paint thinner;
- A device increasing the oxygen level in the chamber is used;
- The compressor has been replaced by a non-approved model;
- Any trace of tampering with the Pressure Regulating Valve is found.

Oxynova® Hyperbaric declares that the appliance will operate faultlessly in the warranty period, provided it will be used in accordance with its intended use and the Operator's manual.

Warranty is only valid if all conditions mentioned in the Lifetime Warranty Statement are fully respected. For repairs, contact the local representative of Oxynova® Hyperbarics.

Hyperbaric chamber:

Model

Serial number

Vendor (Reseller, or Distributor)

Country

Date of acquisition

Signature