

Out & About Seat

User Manual



Model# Series
66XXXXXX
UMOAS01-20LIT

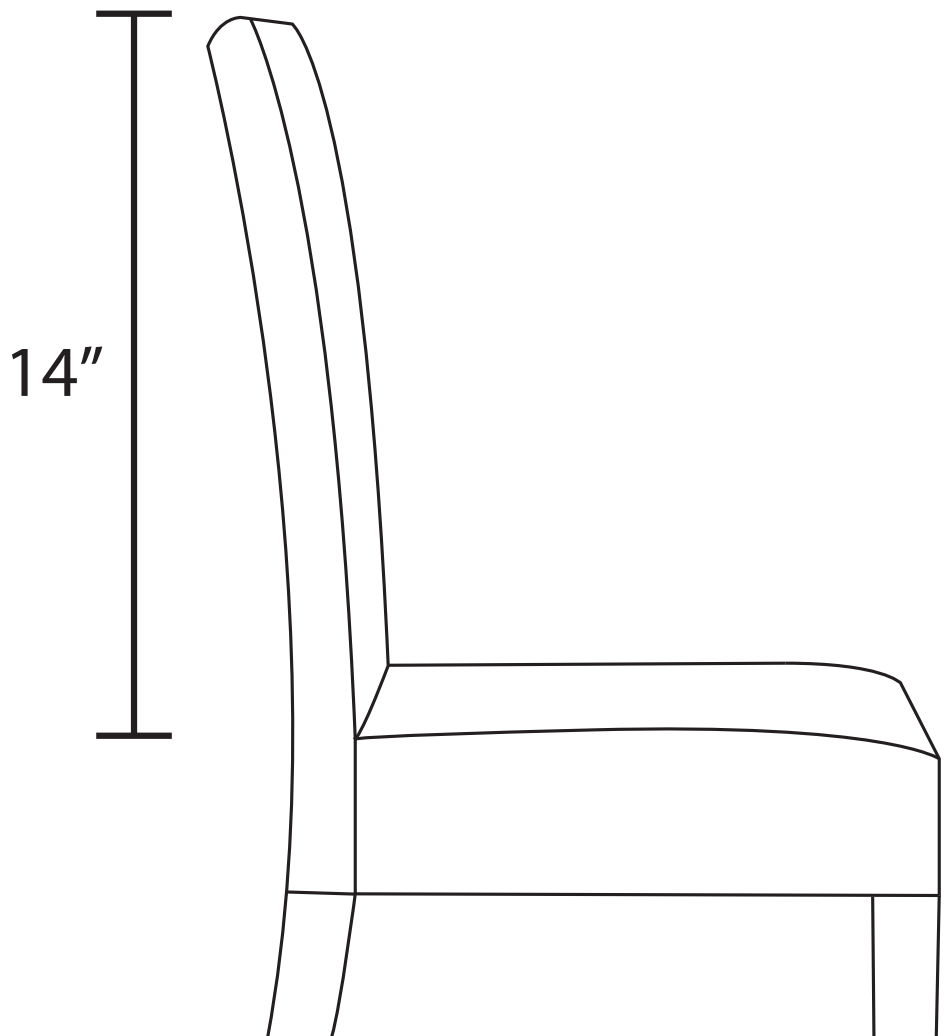

Table of Contents

Intended Use	3
Unpacking Your Out & About Seat	5
Assembly	7
Base Fabric and Seat Bight Strap.....	7
8-Point Positioning Harness System.....	8
Fabric Pad.....	10
Optional Seat Liner Cushion	11
Optional Back Liner Cushion	12
Shoulder, Chest, Waist, & Crotch Pads	13
Winged Headrest	14
8-Point Positioning Harness Adjustment.....	15
Folding for Storage and Transport	16
Washing Instructions	18
Warranty & Contact Information	20

Intended Use

- The Out & About Seat (OAS) is intended to provide limited upper body postural support for children with disabilities who have the capacity to maintain their own head support. The OAS attaches to a structurally stable seating surface that does not already possess or contain an integrated safety belting system.
- The OAS is designed for short-term usage and is not a primary seating system, due to the needs of the child to be repositioned for reasons of pressure relief, reflux, suctioning, and various other long-term seating requirements.
- The OAS should always be secured onto a stable seating surface that will not tip due to the child's range of motion while seated in the OAS. Suitable chairs include adult-size dining room chairs while seated next to a caregiver, sport stadium and movie theater style seats that include seat-back support, and other stable seats that provide a minimum seat-back height of 14" (See below). Always be aware of the abilities and inabilities of the child using the OAS, making sure that you **NEVER** leave the child unattended.
- The OAS **MAY** work on various ADA Compliant swings. As the manufacturer, we are not able to test the OAS on every commercial swing available, therefore the use of the OAS on swings is recommended **ONLY** if it can be secured to a swing using **all straps** provided so that there is no movement of the OAS on the swing. **NEVER** leave a child unattended.
- The Out & About Seat (OAS) may be used in strollers, trolleys, and pushchairs provided that **all** OAS attachment straps can be securely tightened to the frame of the aforementioned devices. The OAS must be secured to a chair with a **minimum seat-back height of 14 inches (35.5 cm)** in order for the OAS Chair Back Strap and Seat Bight Strap to function as required.



Please read these warnings before using your Out & About Seat.

 **WARNING:** AVOID SERIOUS INJURY FROM FALLING OR SLIDING OUT. ALWAYS USE THE OUT & ABOUT SEAT 8-POINT HARNESS. NEVER LEAVE OCCUPANT UNATTENDED.

 **IMPORTANT:** READ THESE INSTRUCTIONS CAREFULLY BEFORE USE AND KEEP THEM FOR FUTURE REFERENCE. THE OCCUPANT'S SAFETY IS YOUR RESPONSIBILITY.

 **AVOID SERIOUS INJURY:** ALWAYS ENSURE THE OUT & ABOUT SEAT IS FIRMLY SECURED TO CHAIR BEFORE USE, AND ALL STRAPS REMAIN TIGHT.

GENERAL INFORMATION & SAFETY

- Follow all instructions carefully. Incorrect use can cause damage to the Out & About Seat.
- The 8-Point Positioning Harness must be correctly installed and adjusted before using the Out & About Seat. See **Page 8** for instructions.
- Always ensure the Out & About Seat is firmly secured to chair before use, and all straps remain tight.
- The Out & About Seat is NOT approved for use in motor vehicles.
- If using the Out & About Seat in an ADA-approved swing seat, do not swing/push with excessive force. Supervision is required at all times when the child is in a ADA-approved swing.
- Never leave occupant unattended.
- Never allow occupant to stand on any part of the Out & About Seat.
- Never leave the Out & About Seat exposed to prolonged direct sunlight or close to heat sources, e.g. a radiator or open flame.

CARE AND CLEANING

- Before each use, ensure that all product straps and buckles are in good working order and show no signs of fraying.

CLEANING

- The Out & About Seat may be cleaned using a damp cloth with mild detergent. Always air-dry the Out & About Seat before use or storage.
- In order to machine-wash the Out & About Seat, refer to **Page 18** for detailed washing instructions.
- Store Out & About Seat in a cool, dry location. Never fold or store the Out & About Seat if the product is not completely dry.

Unpacking Your Out & About Seat

Your Out & About Seat should include the following:

Base Fabric

Front

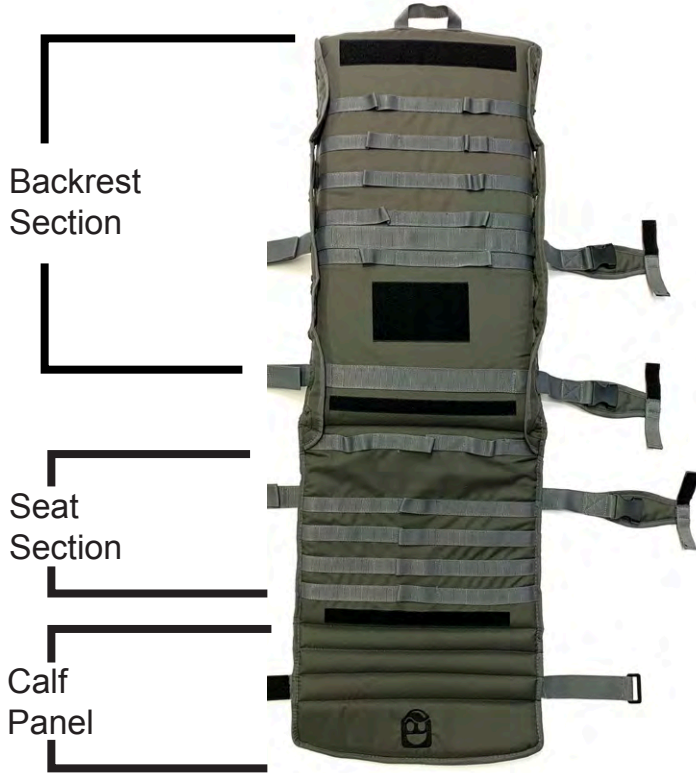

Back



Fabric Pad



Winged Headrest

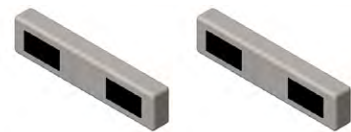

Unpacking Your Out & About Seat

8-Point Positioning Harness System

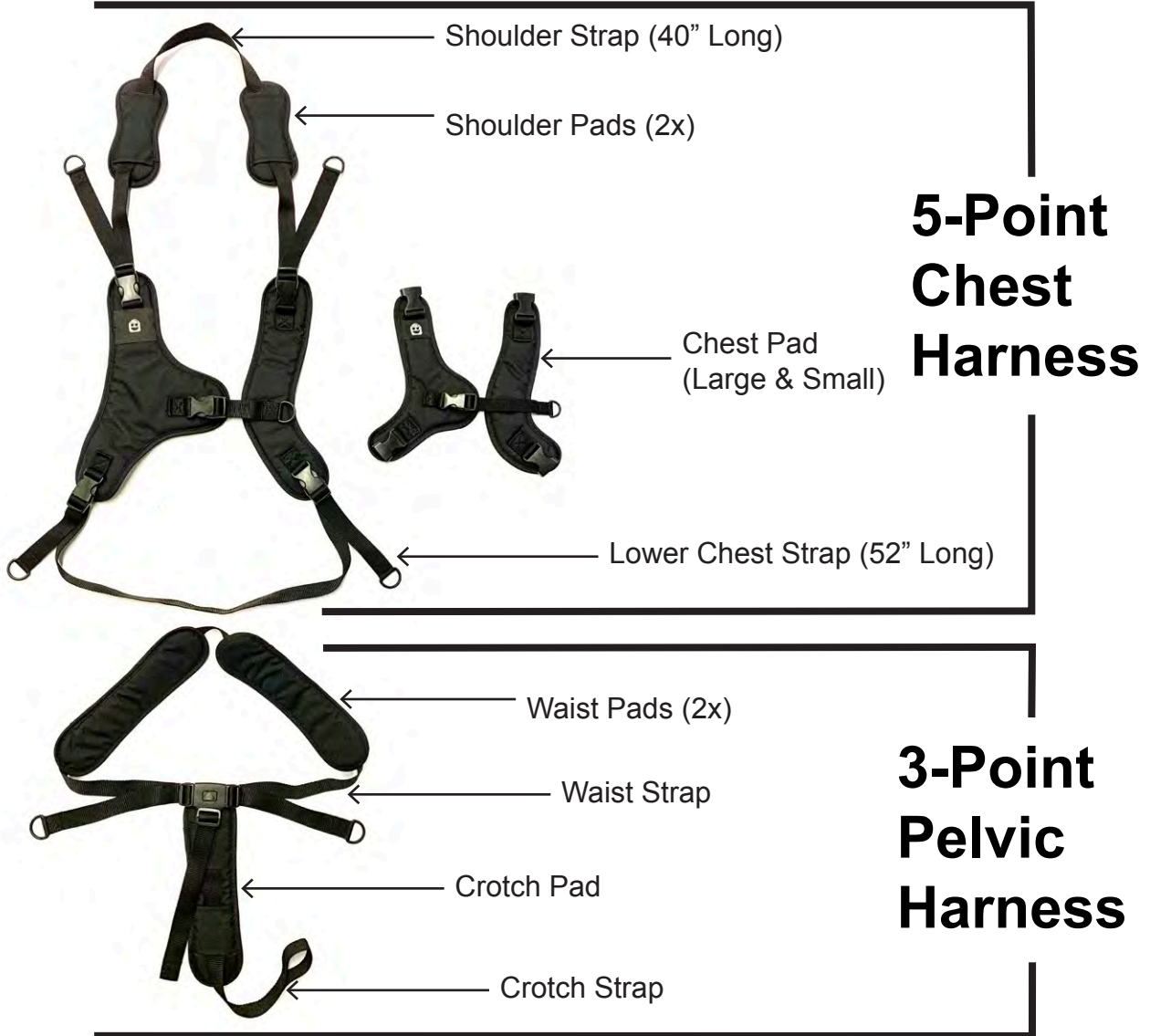

Optional: Seat and Back Liners

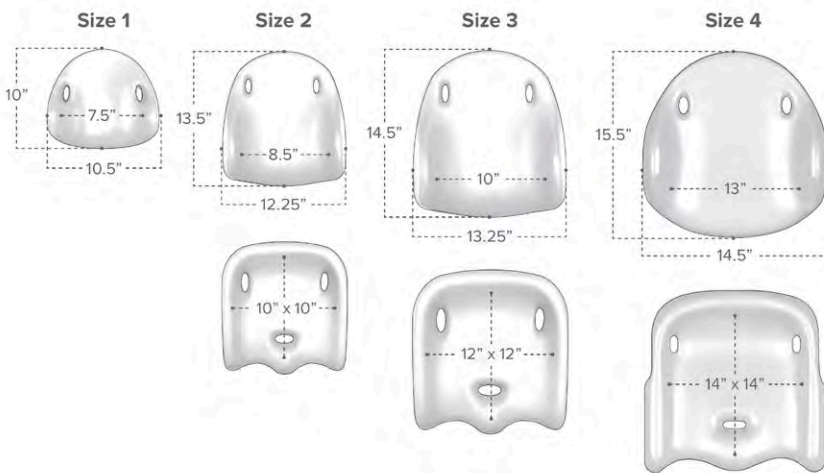

NOTE: Depth of Back Cushions are 1" thick at the narrowest point and 4" thick at the widest point.

Assembly Base Fabric and Seat Bight Strap

Base Fabric



What you'll need for this page:

1. Place **Base Fabric** on chair.



2. Buckle **Chair Back Strap** and **Seat Bight Strap** around back of chair, then tighten.

Tip: Coil excess strap and secure with hook-and-loop strips.



3. Buckle and tighten the **Chair Seat Strap** underneath chair.



4. Buckle and tighten the **Calf Panel Strap** around front legs of seat.



Assembly 8-Point Positioning Harness System



3-Pt. Pelvic Harness

What you'll need for this page:



5-Pt. Chest Harness

5. Unpack 8-Pt. Harness System.

Next, remove **Crotch** and **Waist Pads** from **3-Pt. Pelvic Harness** and remove **Shoulder Pads** from **5-Pt Chest Harness** as shown.



6. Feed loop-end of **Crotch Strap** through center **Harness Loop** located at the back of the **Base Fabric Seat Section**.

Then, thread **Crotch Strap** buckle through its own loop-end.



7. Pull **Crotch Strap** buckle upwards to tighten knot.



8. Feed **Crotch Strap** buckle through center sizing loops in **Base Fabric Seat Section**. Choose appropriate end-loop that best fits the occupant.



Assembly 8-Point Positioning Harness System



Waist Strap

What you'll need for this page:

Shoulder Strap (40" Long)
Lower Chest Strap (52" Long)



9. Feed **Waist Strap** through side **Harness Loop** on the **Base Fabric Seat Section**.



10. Continue feeding **Waist Strap** through the **Harness Loop** on the opposite side of the **Base Fabric Seat Section** as shown here.



11. Feed the **Lower Chest Strap (52" Long)** through the same **Harness Loops** as the **Waist Strap**, as shown.



12. Choose **Chest Harness Loops** slightly above the occupant's **shoulder height**.

Then, feed the **Shoulder Strap (40" Long)** through **Harness Loops** on **Backrest** as shown.



Assembly Fabric Pad

What you'll need for this page:



Fabric Pad

13. Align hook-and-loop panel at the top of the **Fabric Pad** with the panel at the top of the **Base Fabric Backrest Section**.

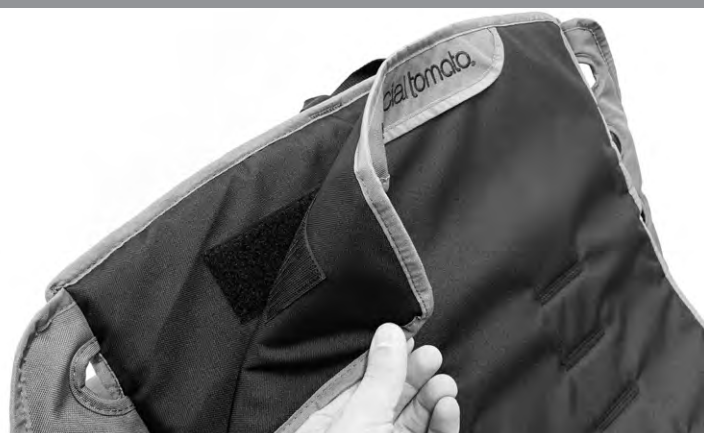

14. Feed ends of **Shoulder Strap, Lower Chest Strap, Waist Strap, and Crotch Strap** through corresponding slits in **Fabric Pad**



15. Align hook-and-loop panel at bottom of **Fabric Liner Pad** with the matching hook-and-loop panel on the **Base Fabric Seat Section** shown here.



Assembly **Optional Seat Liner Cushion**



Seat Liner Cushion

What you'll need for this page:



Seat Liner Attachment Strap

If you are not installing the optional Seat and Back Liners, skip to **Page 13**.

16. First, remove the factory-installed **3-Point Harness** from **Seat Liner** cushion.

Next, ensure that your **Seat Liner Attachment Strap** is at least 52" long to be compatible with the **Out & About Seat**.



17. Feed **Crotch Strap** and **Waist Straps** through the respective cutouts in the **Seat Liner Cushion**.



18. Thread **Seat Liner Attachment Strap** through the lowest **Base Fabric Strap Guide Hole** shown here.



19. Feed **Seat Liner Attachment Strap** behind **Base Fabric Backrest Section** and through the lowest **Base Fabric Strap Guide Hole** on the opposite side. Buckle and tighten.



Note: Position the **Seat Liner Attachment Strap** buckle as shown here. Do not let the plastic buckle contact the Chair to prevent possible scratches.

Assembly **Optional Back Liner Cushion**

What you'll need for this page:



Back Liner Cushion



Back Liner Attachment Strap

20. Ensure that your **Back Liner Attachment Strap** is at least 52" long in order to be compatible with the **Out & About Seat**.



21. Choose a **Base Fabric Strap Guide Hole** at the appropriate height for the occupant, and feed the **Back Liner Attachment Strap** through Base Fabric Strap Guide Hole as shown here.



22. Pass the **Back Liner Attachment Strap** behind the **Base Fabric Backrest Section** and through the opposite **Base Fabric Strap Guide Hole** as shown here. Buckle and tighten.



Note: Once installed, ensure that plastic buckles do not lie directly against Chair surface to avoid potential scratches.



Note: **8-Point Harness and Pads** shown fully-installed here. Refer to steps 23-25 for detailed **Harness Pad** installation instructions.



Assembly **Shoulder, Chest, Waist, & Crotch Pads**

What you'll need for this page:



23. Slide
Shoulder
Pads onto
Shoulder
Straps.



24. Buckle
Chest Pad
to Shoulder
Straps and
Lower Chest
Straps.

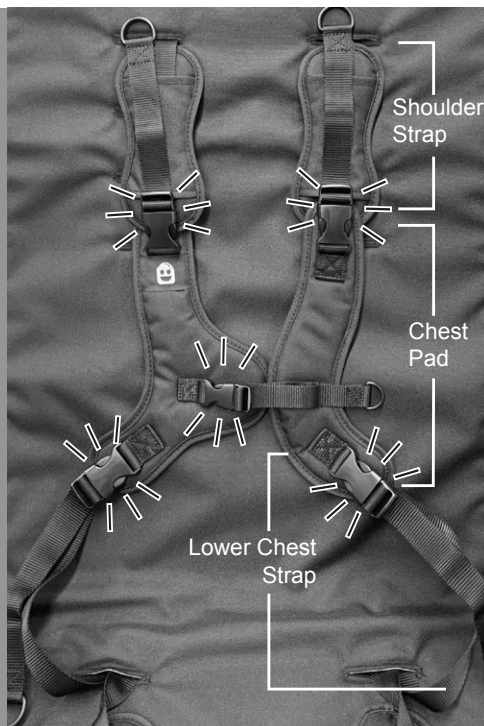

25. Install **Waist Pads** and **Crotch Pad** as shown.



Assembly **Winged Headrest**



Headrest Cushion

What you'll need for this page:



Headrest Support Pads

26. If desired, attach **Headrest Support Pads** to **Headrest Cushion** to adjust depth of **Headrest Cushion**.

Note: Top or bottom **Headrest Support Pad** can be removed to achieve head extension or head flexion as needed.



27. Feed **Headrest Cushion Buckles** through **Base Fabric Strap Guide Holes** at the best height for the occupant. Wrap **Headrest Attachment Straps** behind **Base Fabric Backrest Section**.

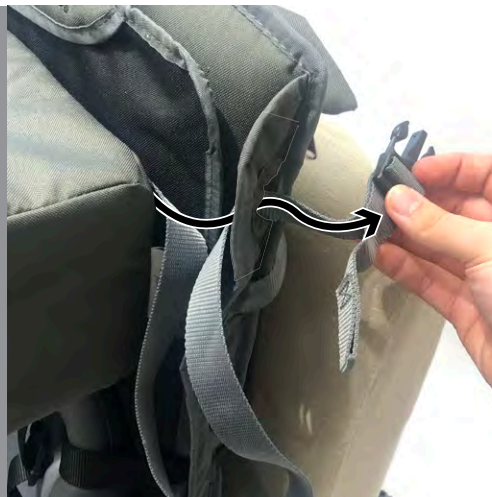

28. Thread the **Headrest Attachment Straps** through **Base Fabric Strap Guide Holes** on opposite side of **Base Fabric**. Clip both **Headrest Cushion Buckles** as shown here.

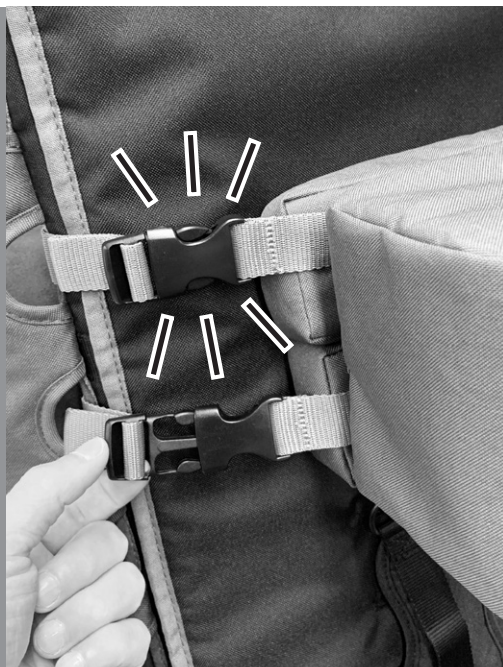

Note: Do not let the plastic buckles contact the Chair to prevent possible scratches.

8-Point Positioning Harness Adjustment

Use this guide to fit the harness to the occupant in order to optimize comfort and safety.

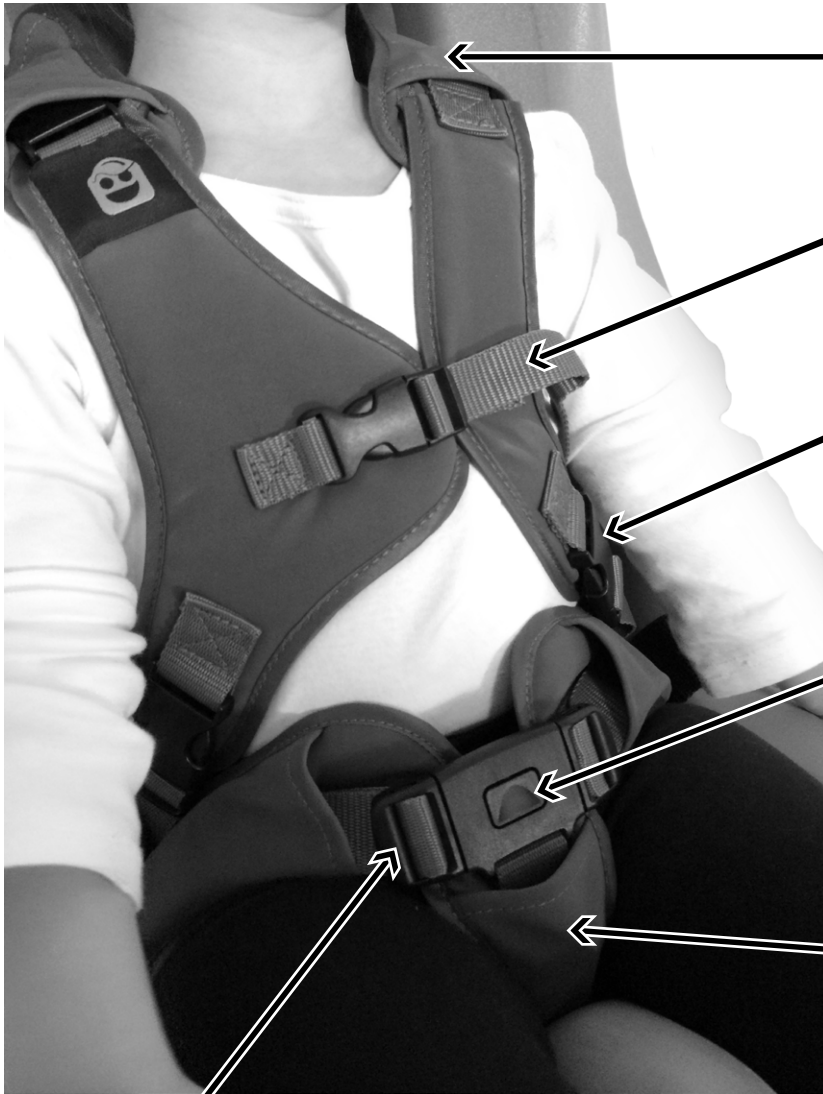

Always use shoulder pads to prevent buckles or webbing from contacting the occupant's neck or face.

To ensure proper placement of the chest harness, make sure the chest strap lies in the middle of the occupant's chest (armpit level).

Lower Chest Straps can be easily adjusted here to fit around bulky clothing like sweaters or coats.

The pelvic harness has a single quick-release button that unlocks both sides of the pelvic harness for quick and easy access to the occupant. The quick-release button requires that you push directly in the center of the buckle to release both waist straps at the same time. This is a safety mechanism in case the occupant attempts to release the buckle on their own.

Adjust the length of the crotch strap to allow the waist straps to lie across the occupant's pelvis. This will prevent the pelvic belt from lying across the lower abdomen.

The pelvic harness has a cam lock which prevents the waist strap from loosening to maintain proper positioning of the pelvis.

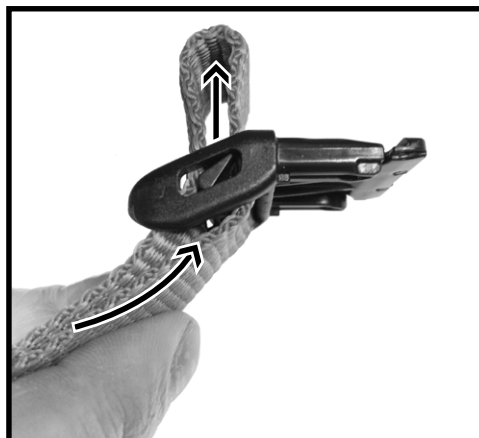

Note: To adjust waist strap length, first push up on webbing to release the cam lock.

Folding for Storage and Transport

1. Unbuckle **Chair Back Strap**, **Seat Bight Strap**, **Chair Seat Strap**, and **Calf Panel Strap**.



2. Drape unbuckled **Chair Back Strap**, **Seat Bight Strap**, and **Chair Seat Strap** as shown. Leave **Calf Panel Strap** loose.



3. Fold the **Base Fabric Seat Section** up to meet the **Backrest Section**.



4. Feed the Long End of the **Calf Panel Strap** through corresponding **Base Fabric Strap Guide Hole** on the left.



Folding for Storage and Transport (2)

5. Wrap **Calf Panel Strap** around the back of **Base Fabric**.

Note: Ensure **Calf Panel Strap** is fed underneath **Backpack Straps**, as shown here.



6. Pass **Calf Panel Strap** through plastic ring as shown.



7. Pull **Calf Panel Strap** tight then secure to hook and loop panel on underside of **Base Fabric**.



8. Connect **Backpack Strap** buckles as shown.



Your **Out & About Seat** is now ready for storage or transport!

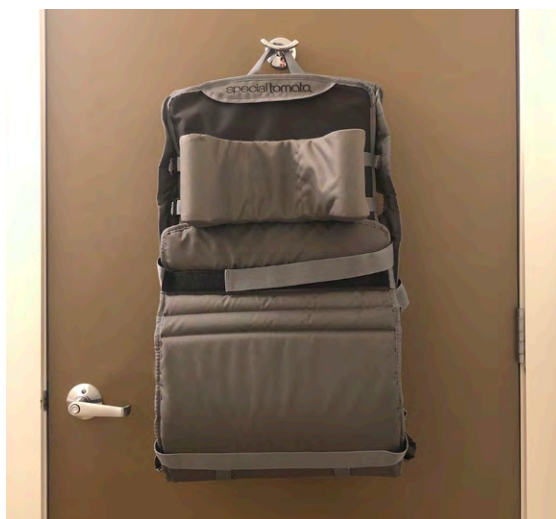

Washing Instructions

To prepare Out & About Seat for machine washing, please follow these steps:

1. Remove all **Harness Pads**.



2. Remove **Fabric Liner Pad**.



3. Remove **8-Point Harness** from **Base Fabric** and clip all harness buckles together as shown here.



Place **8-Point Harness** and **Harness Pads** into mesh laundry bag before washing.

4. Re-install **Fabric Liner Pad** to **Base Fabric**.



Washing Instructions (2)

5. Open zipper compartment located at top of **Base Fabric** to reveal black Plastic Support Frame and Internal Foam Cushion.

First remove the black Plastic Support Frame, then remove the Internal Foam Cushion.



6. Buckle three **Securement Straps** as shown (circled).



After Washing:

Once **Out & About System** is completely dry, first re-install Internal Foam Cushion into **Base Fabric** back compartment. Next slide Plastic Support Frame into **Base Fabric** compartment as shown.

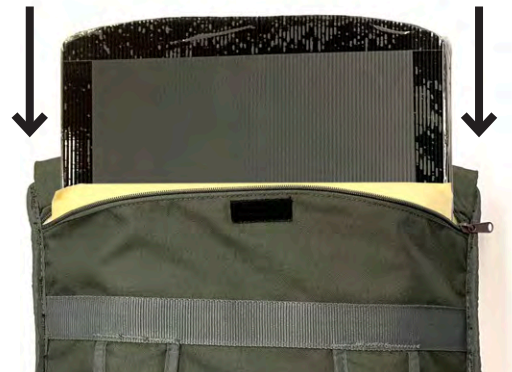

- **Note: Ensure all hook-and-loop panels on the OAS are secured to themselves before washing so that there are NO exposed hook panels. Exposed hook panels can catch on loose fabric and cause fraying during the wash cycle.**
- Wash in cold water with mild detergent on gentle cycle.
- Do not put fabric in dryer.
- Allow all components to completely air-dry before re-assembly.
- Once all components are completely dry, refer to **Page 8** for **8-Point Harness** installation instructions.

Warranty & Contact Information

LIMITED WARRANTY:

The Out & About Seat is guaranteed to be free from manufacturing defects for a period of 2 years from the date of purchase. Normal wear-and-tear is not covered. This warranty extends only to the original retail purchaser and is only valid when supplied with proof of purchase. Please retain proof of purchase with this Limited Warranty.

Please contact the retailer where the Out & About Seat was purchased for all service and repair inquiries.

Please note that your Limited Warranty does not cover:

- Damage caused by misuse, accident, improper maintenance, or failure to follow product manual instructions
- Repairs carried out by a third party
- General wear and tear resulting from everyday use



WARNING: Prevent serious injury or death from falls or sliding out

- **Always secure occupant in the restraint**
- **Never leave occupant unattended**
- **Always keep occupant in view**
- **Always securely tighten attachment straps**
- **Max User Weight 200lbs / 90kg**

