



orin
Rotating Bed



Client First

Headquartered in High Point, North Carolina, we strive to provide the highest quality products and customer service through our team of associates and three distribution centers in the US.

CHARME

CHARME HEALTH TECH

Charme Inc. is incorporated in Delaware, US and operates across the US, Europe and Asia. Through starsleep™, Charme is committed to revolutionize the world of smart bed industry with its strong manufacturing capabilities and global distribution network. Our team of sleep specialists and engineers are dedicated to technological innovation and providing the best possible sleeping experiences.

orin

Like nothing else on the market today, Orin provides care, comfort, security and independence to the highest standard through our innovative product design.



Our Customer Profiles

Diabetes	Cancer
Pregnancy	Stroke
Acid Reflux	Arthritis
Sleep Deprivation	Wheelchair Bound



All-In-One Features

Ergonomic Design	90° Rotation Get Out Of Bed	4D Air Fiber Mattress Washable & Breathable	German Technology	Zero-G	Head & Foot Articulation	One Touch Flat	Air Chamber Massage
Heating	170kg Bearing Capacity	Sideboards Protection	Adjustable Height	Wired Remote	Sleep & Health Monitoring	Sleep Report	Out of Bed Alarm



WATCH VIDEO

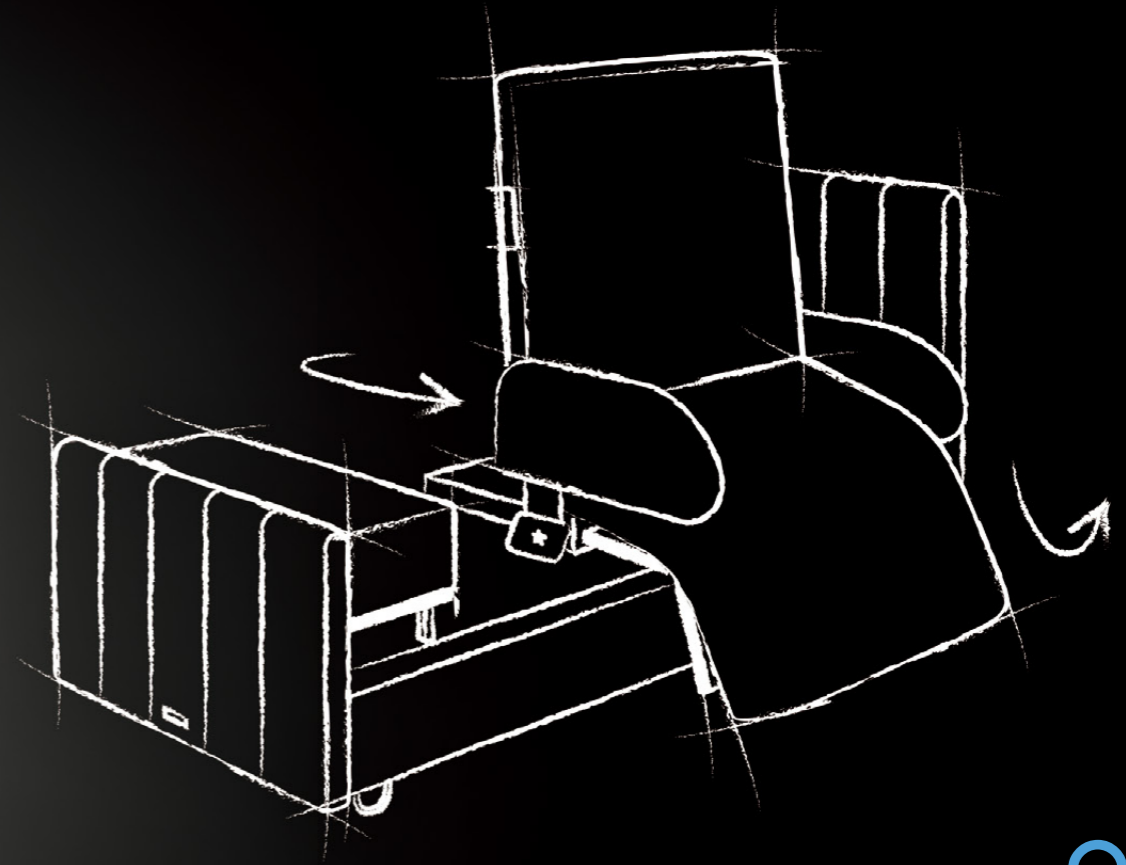

orin



Ergonomic Design

Like nothing else on the market today, Orin provides care, comfort, security and independence to the highest standard through our innovative product design.

Orin Rotation Bed

Key Features

- Multifunctional Design
- Silent & Durable German Motor
- One-Touch 90° Rotation Bed
- Head (90°) and Foot (35°) Elevation
- Air Chamber Massage
- Heating
- Air Fiber Breathable Mattress
- Sideboards & Safety Belt For Protection
- US FDA Registered For Bed & Mattress
- Sleep & Health Monitoring Apps
- 170kg Weight Capacity





Step 1

Head Elevation



Step 2

Leg Elevation



Step 3

Steady Rotation

Step 4

Easy To Get Out

Multifunctional Design
One-Click Control

90° rotation helps users to get in and out of bed easily.

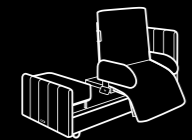

90° Rotation
Get Out Of Bed



Rotate 90°
(easy to get out)

Orin Rotation Bed Dimension

2 Bed Models for Selection

Left Rotation | Right Rotation

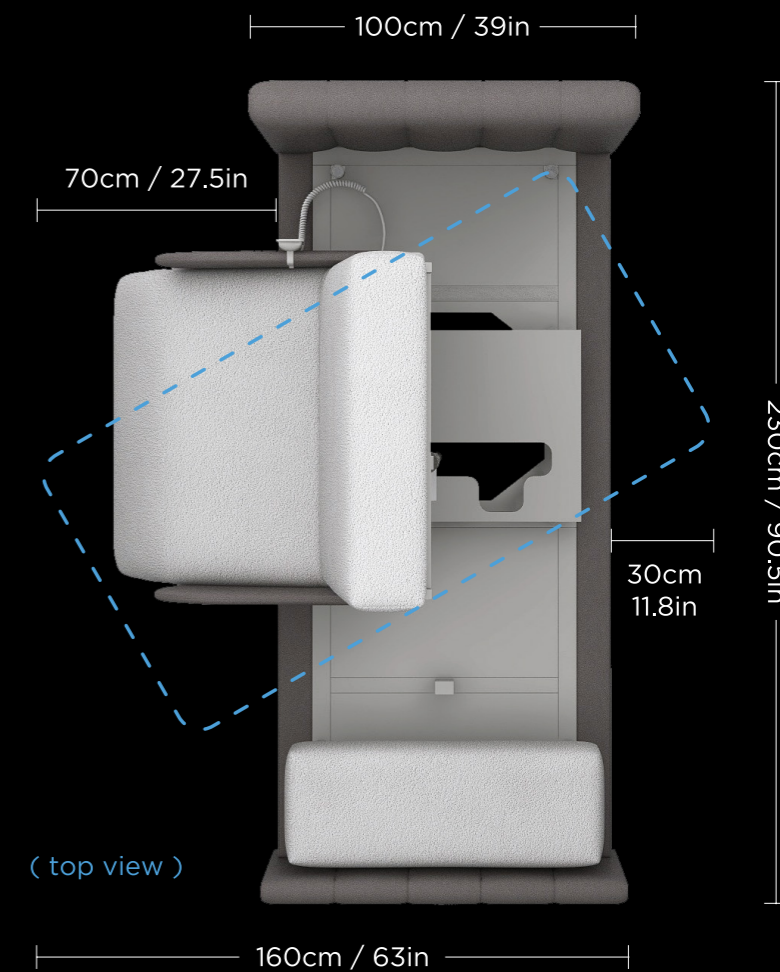
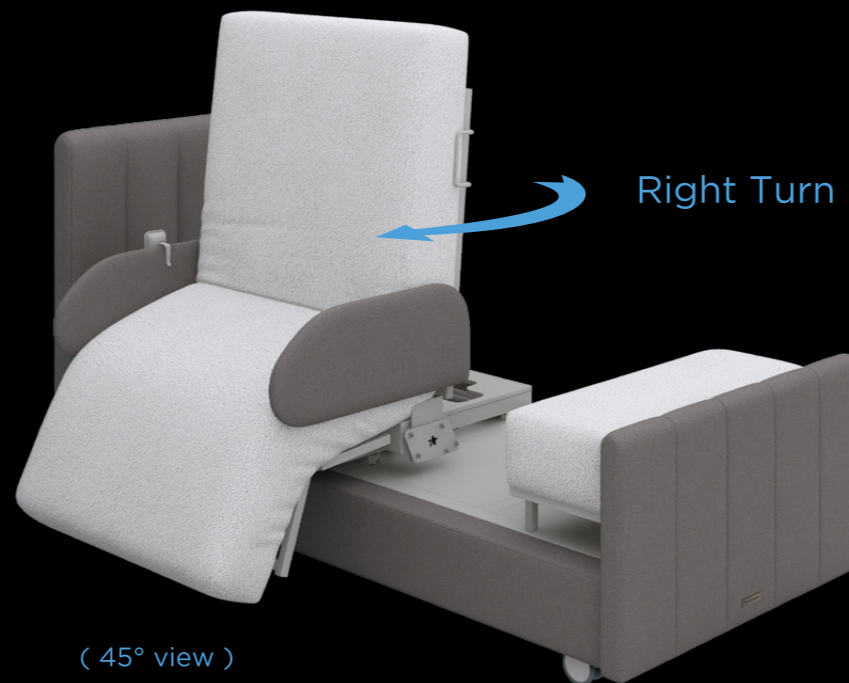
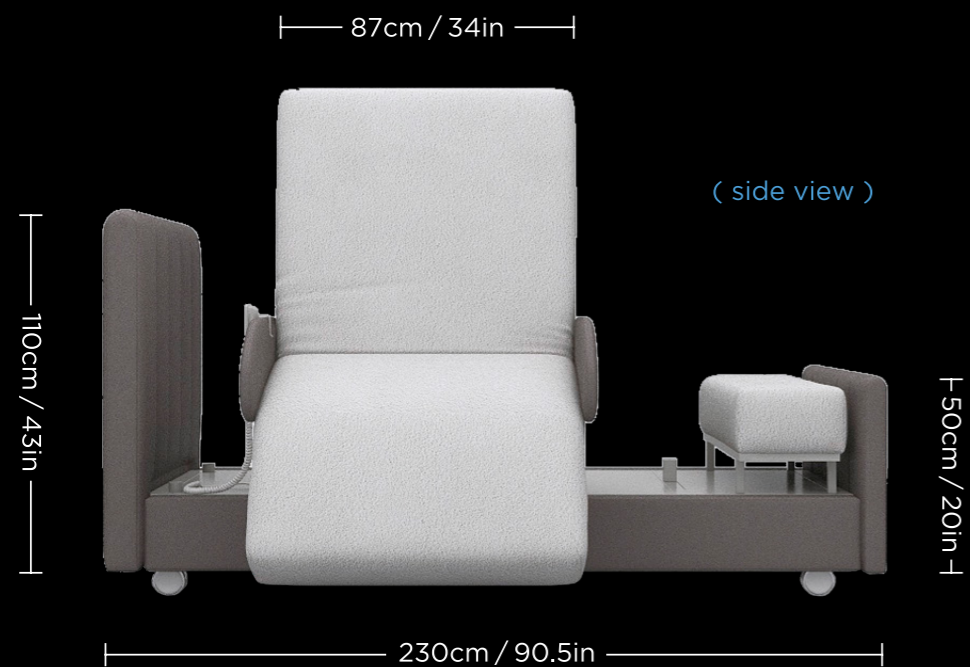

Air Massage with Heating Option

The massage airbags consist of four independently controllable airbags that are installed inside the mattress for use. Three massage modes can be achieved by inflating and deflating the airbags. The waist airbags can also function as lumbar support. If there is no operation, the airbags will automatically stop running after 45 minutes.

The heating function is provided by a 29V heating pad. If left unattended, the heating pad will automatically stop after running continuously for 60 minutes.

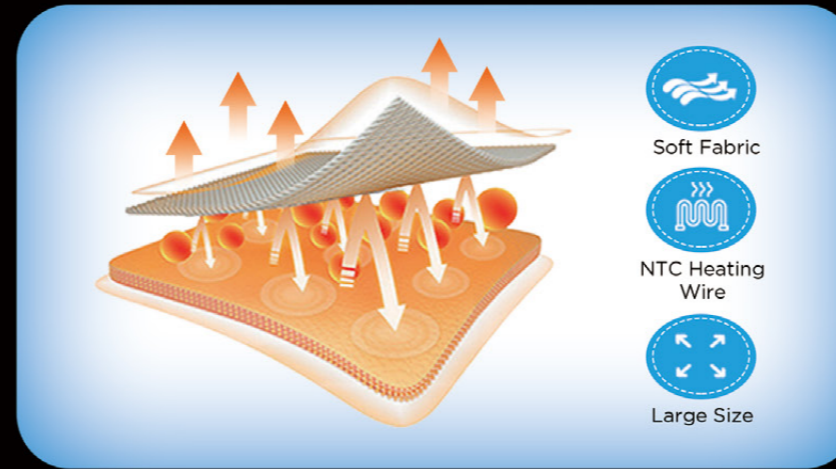

3 Modes To Offer Personalized Care

4-Zone Massage

40°C Heating



Air Chamber Massage



Heating

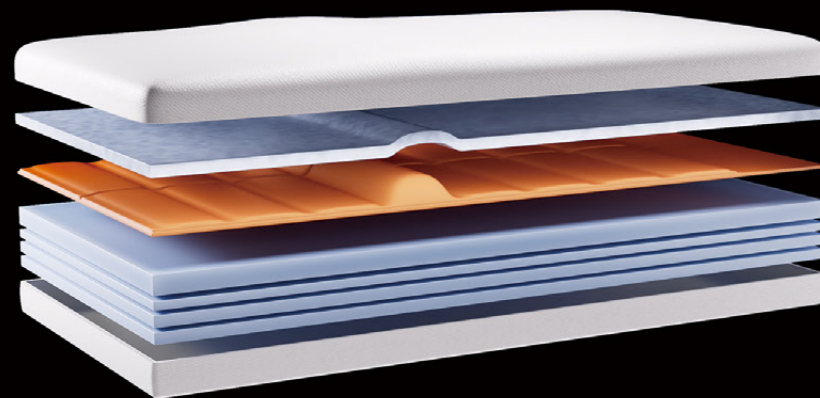

◀ Air Chamber



German Technology

High Efficiency / Silent / Safe & Stable



German Technology



Head & Foot Articulation



One Touch Flat



170kg Bearing Capacity

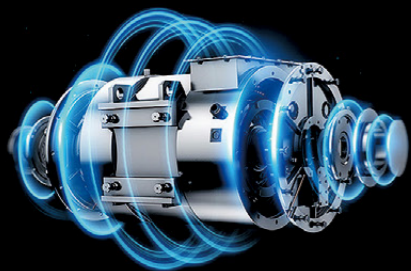

< 50dB Low Noise
> 25000_{order} Durable
> 170kg Stable Load-Bearing
Flame Retardant Medical Standard

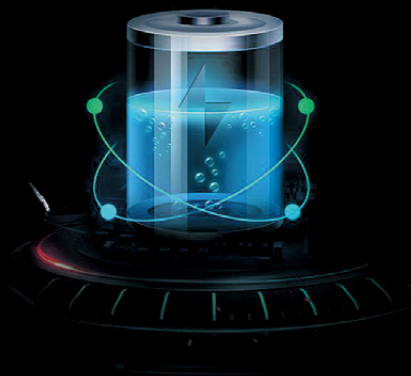

Ensures Normal Use
During Power Outage

Improve care and reliability.



Durable
> 25000_{order}

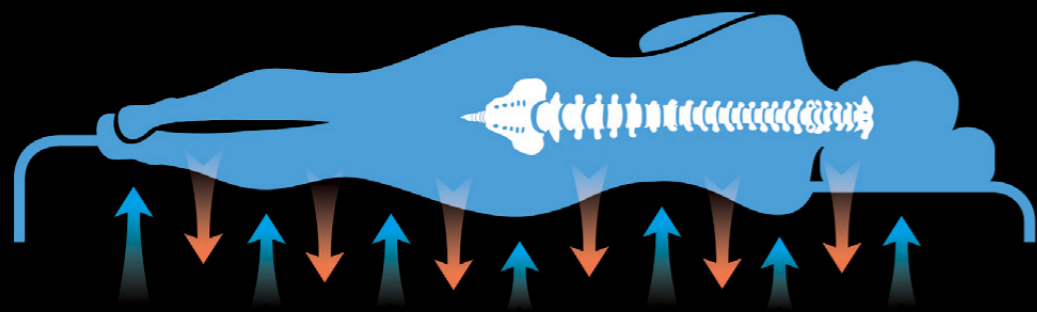

Spine-Protecting High-Density Mattress

Designed to fit every body type. Breathable, silent & non-disturbing. Instantly boost sleep quality.

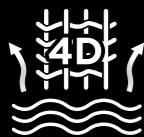

4D Air Fiber Mattress
Washable & Breathable



Ergonomic Design



Zero-G

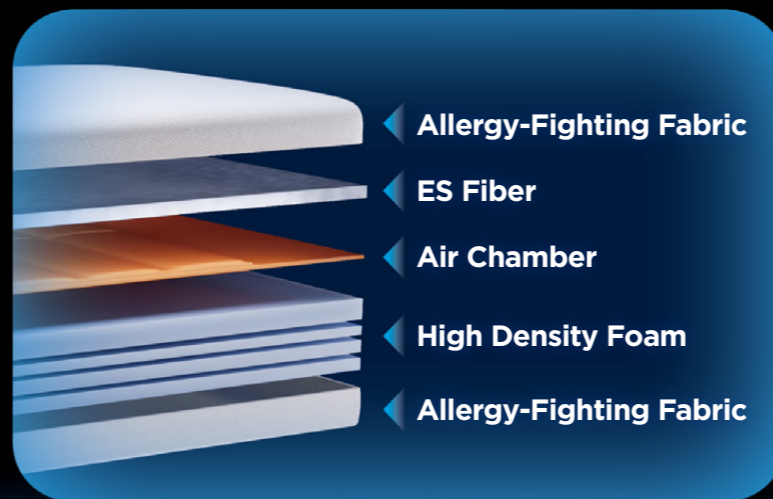



Application Scenarios

Caregiver Group

Medication Record

Diet Record

Chronic Disease Management

Overnight Risk Warnings

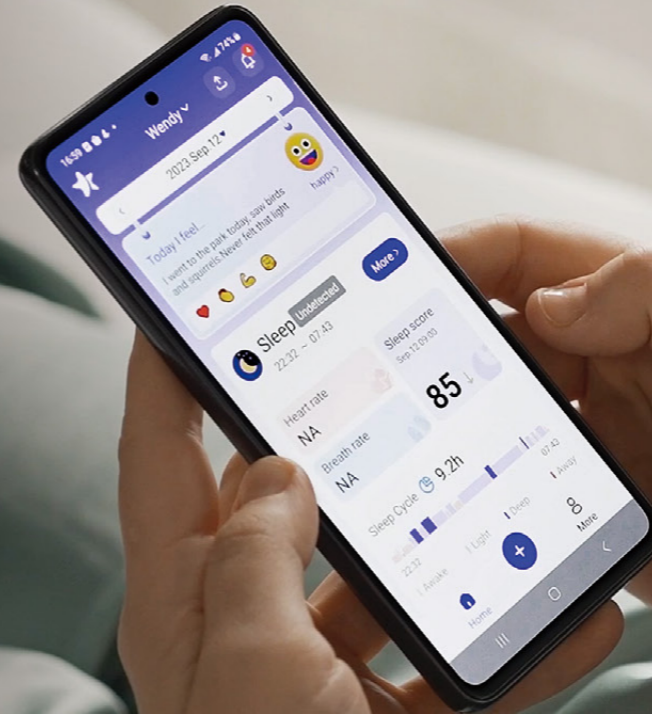



Non-intrusive Sleep Tracking Technology Real Time Alarm & Notification For The User & Family Members



Sleep & Health
Monitoring



Sleep Report



Out of Bed
Alarm

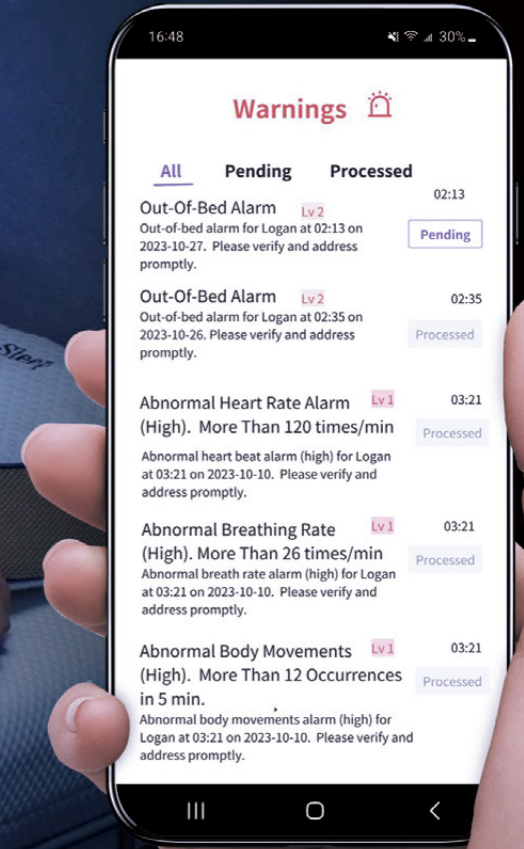

Orin-Accessories
Safety Protection



Step 1

Lock Safety Belt



Step 2

Adjust Tightness



Orin-Accessories Safety Protection



Sideboards
Protection



Orin-Accessories Overbed Table

- Multi-Home Scenarios
- Mobile, Sturdy & Durable
- Practical & Space Saving
- Air-Spring Assist, Easy Operation
- 75cm to 115cm Height Range
- 30kg Weight Capacity



Accessories to
Extend in-Bed



Bearing Capacity
30kg



Easy Cleaning

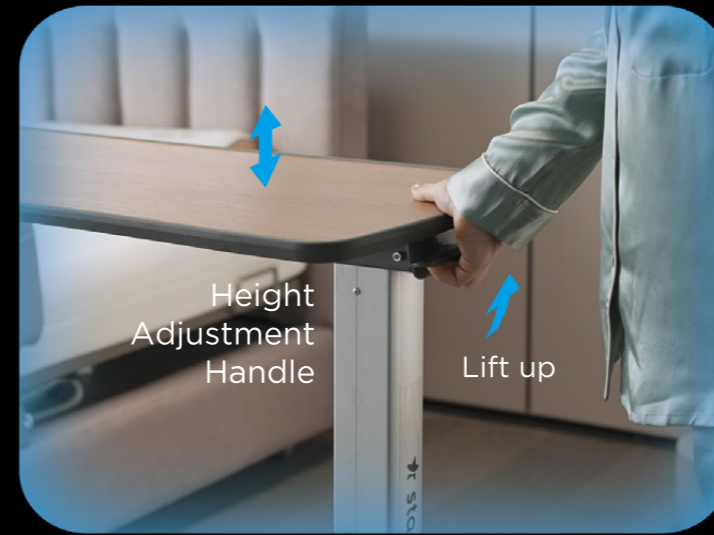

(45° view)



(front view)

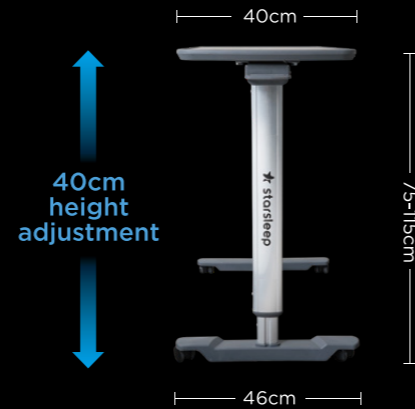

(side view)



Orin-Accessories Transfer Chair

- Ergonomic Design
- Electric - Easy Height Adjustment
- Easy Access To Toilet
- Cleanable
- Chargeable Battery
- 25cm Height Adjustment
- Mute and Lockable Casters
- 135kg Safety Weight Load



Easy To Move



Easy Access To Toilet



(front view)



25cm height adjustment



(side view)



(45° view)

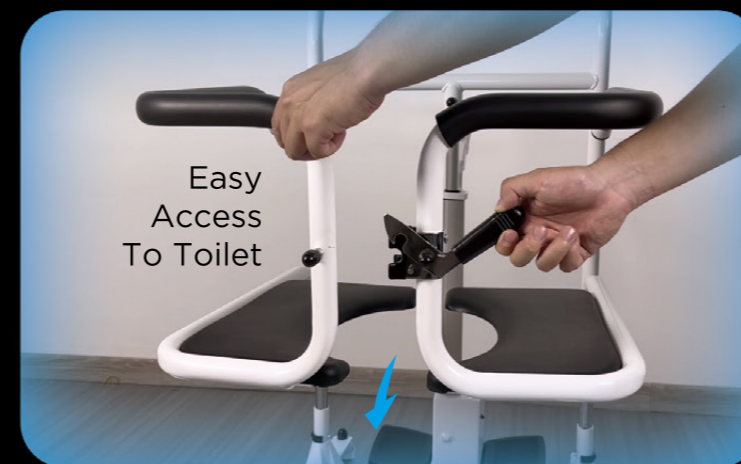

Easy Access To Toilet

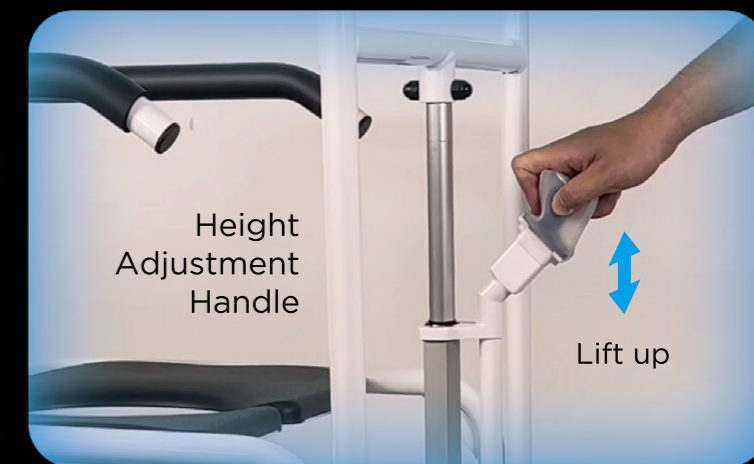

Height Adjustment Handle

Lift up



**Natural
Latex Pillow Core**



**100% Cotton
Home Textiles**

Orin-Accessories Pillow / Home Textiles



Change & Wash



Soft Touch

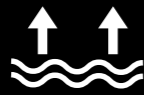

Breathability



Natural
Skin-Friendly



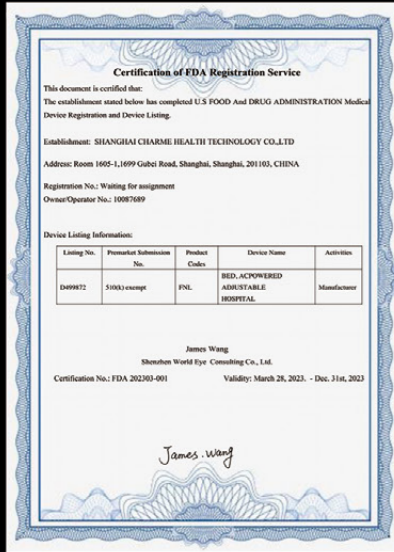

Our Factory

Starsleep's products are produced leveraging Charme's global supply chain system, incorporating Italian design, German technology, Swiss innovation, and North American quality control standards. By combining materials and production cost advantages from various regions in Asia, we optimize the manufacturing process. We have always advocated the concept of a high-quality lifestyle, embracing a life philosophy of 'Freedom, Balance, Wisdom and Taste,' and embodying the brand principles of 'respect, integration, innovation, and gratitude.' Starsleep not only focuses on high-quality materials, practical products, and reasonable pricing but also strives to provide users with a more practical, innovative, and comfortable home experience, making the wisdom and enjoyment of life within easy reach.

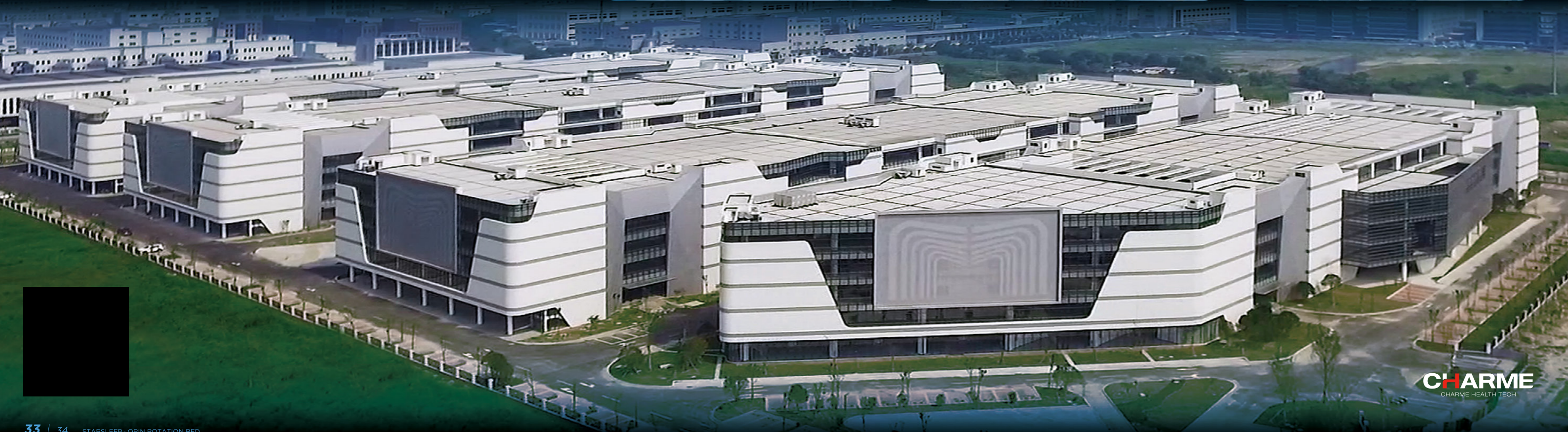
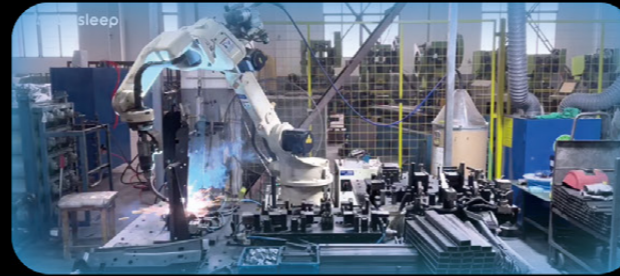

 starsleep™