

MyWay+

Instructions for Use



Supporting
Children

Your new Leckey MyWay+ is here!

MyWay+ is an upright mobility device that supports children, who cannot stand or walk independently, in an upright position. When supported in the product, the wheeled frame allows children to propel themselves about their environment using their lower limbs. This manual shows you how you can quickly and easily make use of all the MyWay+ functions. The instructions on the safety and maintenance of the product will ensure that you will enjoy the use of this product for a long time.

The Leckey MyWay+ comes partially assembled and your box should contain the following as standard:



If you have ordered any of the optional accessories, these will also be included in the box. Optional accessories include:



1. Saddle



2. Saddle drop



3. User handles



4. Complex user handles

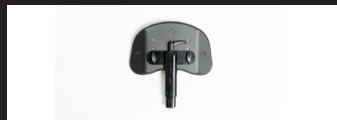

5. Head rest



6. Complex head rest



7. Adult handles



8. Hoist straps



9. Ankle guides

Contents

01	Intended Use	p.04
02	Declaration of Conformity	p.04
03	Warnings and Cautions	p.04
04	Terms of Warranty	p.06
05	Product History Record	p.06
06	Product Training Record	p.06
07	Safety	p.07
08	Contra-indications / Cautions	p.08
09	Main Frame Set-Up / Features	p.09
10	Harness Set-Up / Features	p.22
11	Accessories Set-Up / Features	p.32
12	Typical Set-Up Order	p.44
13	Cleaning and Care Information	p.46
14	Daily Product Inspection	p.47
15	Annual Product Inspection	p.48
16	Re-issuing Leckey Products	p.49
17	Product Servicing	p.49
18	Technical Information	p.50
19	Product and Accessory Codes	p.52



Please read the following guidance and instructions fully before using the Leckey MyWay+.

Please also refer to these instructions before making any adjustments to the device.

Failure to follow these user instructions may put the user at risk.

Please note, these instructions have been written according to the different product components- the main frame set-up/features, the harness set-up/features and accessories set-up/features. They have not been written in a specific set-up/adjustment order as this will depend on the individual user. Please read these instructions to familiarise yourself with the product features and then refer to section 12 for a guide to a typical set-up order.

1.0 Intended Use

- MyWay+ is an upright mobility device that supports children, who cannot stand or walk independently, in an upright position and allows them to move about their environment.
- MyWay+ is intended for children and young people with a physical disability/ gross motor delay which prevents them from independent upright mobility; for children and young people with Cerebral Palsy (or other equivalent conditions) in GMFCS levels III- V (who have sufficient range of movement in their lower limbs to enable passive/ active stepping).
- The MyWay+ Size 1 frame is suitable for users up to 25kg and a shoulder height of 870mm; the Size 2 frame is suitable for users up to 50kg and a shoulder height of 1190mm; and the Size 3 frame is suitable for users up to 80kg and a shoulder height of 1490mm. **Please see section 8.0 Contra-indications/ Cautions' for further information.**

2.0 Declaration of Conformity

The MyWay+ is classified as a Class I Medical Device under EU and UK regulations. James Leckey Design Ltd as manufacturer with sole responsibility declares that the Leckey MyWay+ conforms to the requirements of the 93/42/EEC Guidelines, Medical Device Regulations 2017, UK Medical Devices Regulation 2002 and EN 12182 Technical aids for disabled persons and test methods.

Notice to the user and/ or patient: Any serious incident that has occurred in relation to the device should be reported to the manufacturer and the competent authority of the Member State in which the user and/or patient is established. NOTE: General user advice. Not following these instructions may result in physical injury, damage to the product or damage to the environment!

3.0 Warnings and Cautions

3.1 Warning | Toppling Hazard

- Never use the product on a sloping surface greater than 5 degrees or on uneven or rough terrain.
- Always brake the castors before placing the user in the product.

- Possible tip hazard for users of max height for each frame size, where the user is capable of lifting frame off ground. Risk assessment to be carried out to assess suitability of user.

3.2 Warning | Finger Trap Hazard

- Ensure that the user or carer does not touch any moving joint or pivot that is not locked.

- While the user is in the product, the carer should strive to keep product adjustments to a minimum.
- Take care when tensioning the pulley straps.

3.3 Warning | Occupant Security

- User transfers in and out of the product must be done with appropriate equipment and personnel.
- Allow adequate space for child and carers movement during transfer.
- Ensure that the harness and shoulder straps are securely applied.
- If the user exhibits any form of distress, remove from the product as quickly as is safely possible.
- Users should not be left unattended at any time whilst using Leckey equipment.
- Ensure sufficient clearance of any straps from the user's neck, during use of the product and transfers, to avoid any strangulation risk.

3.4 Caution | Finger Nip Hazard

- While the user is in the product, the carer should strive to keep product adjustments to a minimum.
- Take care when assembling or adjusting the position of the MyWay+ components that your fingers do not get nipped when positioning MyWay+ components and tightening fixings.
- During product assembly and adjustment, the carer should avoid finger nipping risk of the product's joints or pivots.
- During transfers and adjustments, the carer should avoid the finger nipping risk of buckles.

3.5 Caution | Daily Checks

- The MyWay+ is to be checked daily before use to ensure that the harness, support unit, frame and accessory components are safe for use.

3.6 Caution | Cleaning

- Clean the MyWay+ regularly to prevent the build-up of dirt. Accumulated dirt can prematurely wear the fabric components and encourage corrosion on the MyWay+. Only use non-abrasive household cleaners and moist cloths, do not use running water on the upholstery whilst it is still attached to the MyWay+. See Section 13 of user manual.

3.7 Caution | Cleaning Power Washer/Hoses

- Power washers are not to be used to clean the product. Hoses can be used to clean the outdoor castors.

3.8 Caution | Disposal

- When disposing of the product using community waste disposal site, the frame and any electrical components should be disposed of separately.

3.9 Caution | Bringing into Use

- Before use, allow 2 hours for the product to acclimatise to room temperature.

4.0 Terms of Warranty

The warranty applies only when the product is used according to the specified conditions and for the intended purposes, following all manufacturers' recommendations (also see general terms of sales, delivery and payment). A one year warranty is provided on the MyWay+ harness. Life expectancy of the harness is up to three years. The life expectancy will vary depending on the frequency of use, number of washing cycles and weight carried. A three year warranty is provided on all other non-upholstered MyWay+ components.

5.0 Product History Record

Your Leckey product is classified as a Class 1 Medical Device and as such should only be prescribed, set up or reissued by a technically competent person who has been trained in the use of this product. Leckey recommend that a written record is maintained to provide details of all set ups, reissue inspections and annual inspections of this product.

6.0 Product Training Records (Parents, Teachers & Carers)

Your Leckey product is classified as a Class 1 Medical Device and as such Leckey recommend that parents, teachers and carers using the equipment should be made aware of the following sections of this user manual by a technically competent person:

7.0 Safety

8.0 Contra-indications / Cautions

9.0 Main Frame Set-Up / Features

10.0 Harness Set-Up / Features

11.0 Accessories Set-Up / Features

12.0 Typical Set-Up Order

13.0 Cleaning and Care Information

14.0 Daily Product Inspection

Leckey recommend that a written record is maintained of all those who have been trained in the correct use of this product.

7.0 Safety

- Always read user instructions fully before use.
 - Users should not be left unattended at any time whilst using Leckey equipment.
 - Only use Leckey approved components with your product. Never modify the product in any way. Failure to follow instructions may put the user or carer at risk and will invalidate the warranty on the product.
 - If in any doubt to the continued safe use of your product or if any parts should fail, please cease using the product and contact our Customer Care Team or your local dealer as soon as possible.
 - Carry out all relevant positional adjustments and ensure that they are securely fastened before you put the user into this product.
 - Never leave the product on a sloping surface, greater than 5 degrees. Always remember to lock all the castors.
 - Only hold onto the frame or use the adult handles accessory to steer and move the product from one area to another
 - Never use the upper support unit or any accessory for this purpose.
 - The product contains components which could present a choking hazard to small children. Always check that locking knobs and bolts within the user's reach are tightened and secure at all times.
 - Clean the product regularly. Do not use abrasive cleaners. Carry out maintenance checks on a regular basis to ensure your product is in good working condition.
 - Check all weight bearing components are fully secured before removing manual/hoisting support i.e. saddle, buckles/ cords attaching harness to frame and shoulder straps.
 - The white buckles must be secured first and opened last during set up and exit from the device. The white buckles take the child's weight if they are not bearing weight through their legs.
 - If the groin straps have not been fitted securely, the child may slide down a little within the harness.
- If this results in the harness digging into the child's armpits, then the harness needs to be reapplied more securely. The saddle provides additional support if required.
- If hoisting the child from the device, ensure the groin straps are secured.
 - Failure to follow the user instructions may put the child at risk.
 - The product should be stored carefully and not used if any parts are faulty.
 - Communicate with the child regarding any positional adjustments to be carried out while the child is supported in the device.
 - Leckey products comply with fire safety regulations in accordance with EN12182. MyWay+ satisfies the requirements of EN1021-1, however, the product should be kept away from all direct sources of heat including naked flames, cigarettes, electric and gas heaters

- The product is designed for indoor and outdoor use on smooth, level surfaces. The product is not suitable for use on uneven or rough terrain. When not in use, the product should be stored in a dry place that is not subjected to extremes of temperature.
- The safe operating temperature range of the product is +5° to +40° Celsius.

8.0 Contra-indications / Cautions

Contraindications

MyWay+ should not be used with children with clinical presentations as below:

- Significant leg length discrepancy/ asymmetry which precludes from reciprocal contact with the floor when stepping.
- Discomfort associated with positioning in or out of the device where this cannot be resolved with adjustment of support/ positioning.

Open/healing wounds under areas of pressure including trunk, groin and shoulders.

Precautions

MyWay+ may not be suitable for children with the following presentations:

- Severe dystonic movement which presents a manual handling risk for child and carer when getting the child in and out of the product.
- A portable ventilator.
- Low bone density/ history of frequent fractures (e.g. Osteogenesis Imperfecta).
- A device fed through the abdominal wall, such as PEG and gastrostomy.
- An abdominal device in situ such as Baclofen pump.

- Protruding lesions along their spine (e.g. Spina Bifida)
- Compromised respiratory function, who may experience increased effort of breathing due to fit of harness.
- Significant learning disability or behavioural issues which present risk of injury to the child and/ or carer.
- No/ limited muscle activity or movement of their lower limbs.

All precautions and contraindications are taken at the discretion of the prescribing clinician or parent. Leckey recommends a trained and experienced clinician to be present during all initial assessment, set ups, configurations, and reissues to minimise risk.

9.0 Main Frame Set-Up/Features

9.1 Frame | Unfolding the Frame

- Lift the frame out of the box and set it on a flat, stable surface, keeping it in the same position as it was packaged within the box i.e. as per image below.



Warning – when lifting the frame, adhere to normal moving and handling procedures.



- Stand at the base of the frame's 'U' shape. Pull both triggers.



Warning – fingers should be placed on triggers as shown, to avoid potential for finger nipping.

- Walk the frame's front legs forward, away from you (in direction of arrows), engaging the front casters until the legs are fully extended. Release both triggers.



Warning – if the red rectangle is visible on the triggers once these have been released, the frame legs have not been fully locked out.





Warning – to check if frame legs are fully locked out, lift the frame in an upwards direction - if the legs do not sway/drop etc., the frame and legs are in the correct position. If the legs do sway/drop you must reposition the legs.

9.2 Frame | Folding the Frame

- Stand behind the rear legs of the frame.
- Brake both rear castors- see section 9.6 'Applying/releasing brakes' for instructions.
- Pull both triggers.



Warning – fingers should be placed on triggers as shown, to avoid potential for finger nipping.

- Walk the frame backwards, towards you (in direction of the arrow), until the front legs have folded down on top of the rear legs. Release both triggers.



Warning – never fold the frame without removing the upper support unit first. Please note, this is applicable to sizes 2 and 3 only as the upper support unit does not detach from size 1.



9.3 Upper Support Unit | Handling the Upper Support Unit

- Ensure overall height is adjusted to its highest position- see section 9.12 'Overall Height Adjustment'.



- Place one hand underneath the grey lever on the unit.
- Hold the grey lever on the unit with the other hand.



Note – this section only applies to sizes 2 and 3 as the upper support unit does not detach from size 1.

Warning – the upper support unit weighs 11kg.

Hold the upper support unit close to the body and adhere to normal moving and handling procedures.

9.4 Upper Support Unit | Attaching the Upper Support Unit to the Frame

- Ensure brakes have been applied to all castors - see section 9.6 'Applying/releasing brakes' for instructions.
- Line the spine attachment of the upper support unit up with the receiver slot on the frame. **A**
- Ensure the pulley straps on the upper support unit are placed in front of the frame tubing and are not behind it. **B**
- Then drop the upper support unit down into the receiver slot. The grey lever on the upper support unit should automatically flip down into place. If this does not happen, simply push the lever down. To check if the upper support unit is engaged correctly, lift the support unit upwards. The frame should begin to lift off the ground if properly engaged.

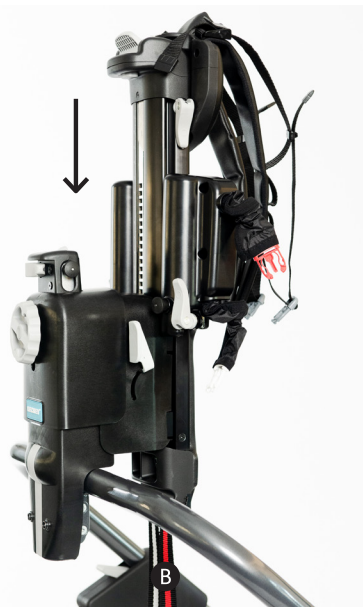

Warning – When attaching the upper support unit, ensure hands are positioned as per guidance in 9.2 'Handling the upper support unit'. Do not hold the unit around the bottom.

Warning – if the product needs to be lifted once the upper support unit has been attached to the frame, ensure normal moving and handling procedures are adhered to due to the product's weight.

9.5 Upper Support Unit | Detaching the Upper Support Unit from the Frame

- Ensure overall height is adjusted to its highest position - **see section 9.12 'Overall Height Adjustment'**.
- Ensure brakes have been applied to all castors - **see section 9.6 'Applying/ releasing brakes'** for instructions.
- If the pulley straps are attached to the clips at the bottom of the frame, ensure the pulley straps are released before attempting to detach the upper support. **A**
- Place one hand on the unit, underneath the grey lever **B**, pull out and hold onto the grey handle with the other hand **C**.
- Lift the upper support unit out of the frame's receiver slot.



Warning – do not attempt to detach the upper support unit whilst the user is in the product. Ensure the user has been transferred out of the product first.

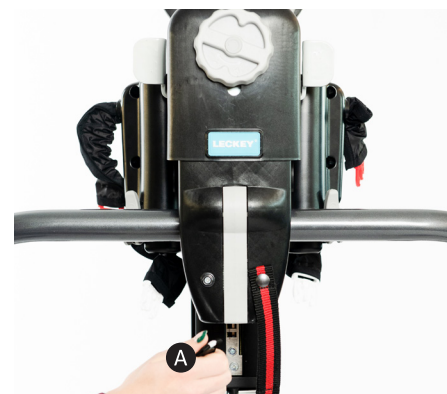

MYWAY+ IS SUITABLE FOR USERS UP TO:

Maximum Weight of

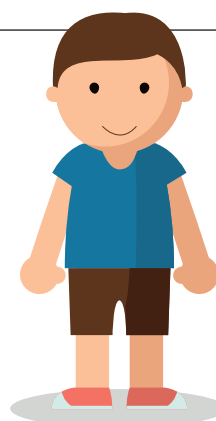

and shoulder height of
1490MM
accommodated by the Size 3



When approaching MyWay+ sizing limits, a risk assessment should be carried out to assess the suitability of the particular MyWay+ frame size for a user.

Size 1 is suitable for users up to 25kg and a shoulder height of 870mm; size 2 is suitable for users up to 50kg and a shoulder height of 1190mm; size 3 is suitable for users up to 80kg and a shoulder height of 1490mm.



The product is suitable for use indoors and outdoors on smooth, level surfaces. Do not use the product on uneven or rough terrain. Potential environments for use should be risk assessed to ensure user safety.

9.6 Castors | Applying/Releasing Brakes

- To apply the brakes, place foot on the brake pedal. Push the brake pedal once **A** until a click is heard. **B**
- To release the brakes, place foot underneath the brake pedal and move it upwards so that the pedal flips back to its original position.



Warning – All four castors should have brakes and direction lock applied when users are transferring in and out of the product. This also applies when any adjustments are being made to the castors and the user is in the product- this will ensure the frame/user does not move unexpectedly.

9.7 Castors | Direction Lock Feature

- To apply directional lock—move the direction lock slider upwards until a click is heard **A**. Then rotate the castor around by moving the frame until you hear another click—the castor has now locked into position. **B**



- Note** – applying directional lock to all four castors will restrict the frame to a forward, straight-line direction only. **A** Applying direction lock to both the rear castors will prevent excessive side-to-side movement of the frame by the user but still allows them the freedom to steer the frame. **B**

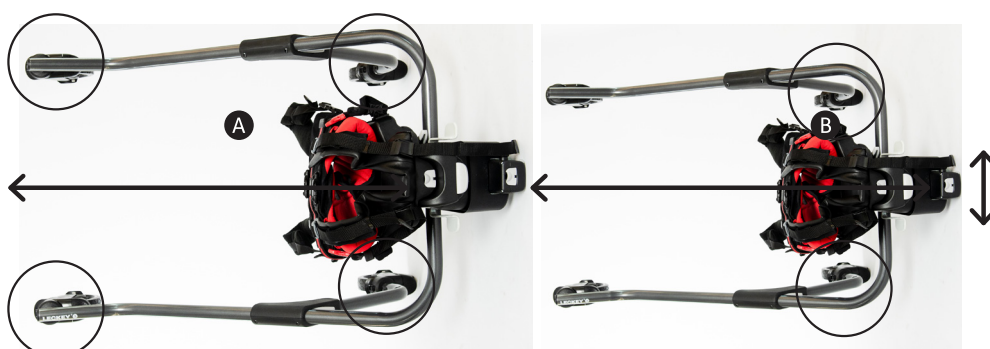

- Side-stepping apply the directional lock and orientate all 4 castors in the same sideways direction. This will allow for the use of side-stepping in both left and right directions of movement as well as use of the anti-roll and resistance functions.
- To release direction lock, depress direction lock slider **A** until a click is heard and it snaps back to its bottom position. Then rotate the castor slightly to check the castor is now moving freely



9.8 Castors | Anti-Roll Back Feature

- Ensure the directional lock feature has been applied to both rear castors – see section 9.7 ‘Direction lock feature’ for details.
- To apply anti-roll back, move the grey slider on the side of the castor towards the one directional arrow icon as far as it will go. **A** Anti-roll back should be applied to at least 2 castors- it will only work on the castors it has been applied to.
- To release anti-roll back, move the grey slider on the side of the castor towards the two directional arrow icon as far as it will go. **B**



NOTE- A clicking sound may be heard when the frame is in motion after the anti-roll back feature has been applied- this is normal and is not a cause for concern.

9.9 Castors | Resistance Feature

- To apply resistance to the castors move the grey slider on the side of the castor towards the ‘+’ icon - the further the knob moves towards the ‘+’ icon, the greater the resistance. **A**
- To remove resistance to the castors move the grey slider on the side of the castor towards the ‘-’ icon - the further the slider moves towards the ‘-’ icon, the lesser the resistance. **B**
- Resistance can be applied independently to each castor to suit user requirements e.g. resistance can be applied to the left/right hand side castors only for an asymmetric user; or resistance can be applied equally to all four castors.



Note – If you are concerned the user may move too quickly in the product and there is potential risk of collision/injury, apply the resistance feature.

9.10 Upper Support Unit Adjustments | Fine Height Adjustment

Note- this section only applies to sizes 2 and 3.

- Grasp both of the fine adjustment handles. **A**
- Push the adjustment handles downwards until you hear a click **B**, then pull the handles upwards until you hear a click and vice versa, continuing until you achieve the desired position. The fine height can only be adjusted upwards in increments of 10mm.
- If you finish on a downwards stroke, the adjustment handles will be facing outwards - ensure the handles are pushed upwards, out of the way. **C**

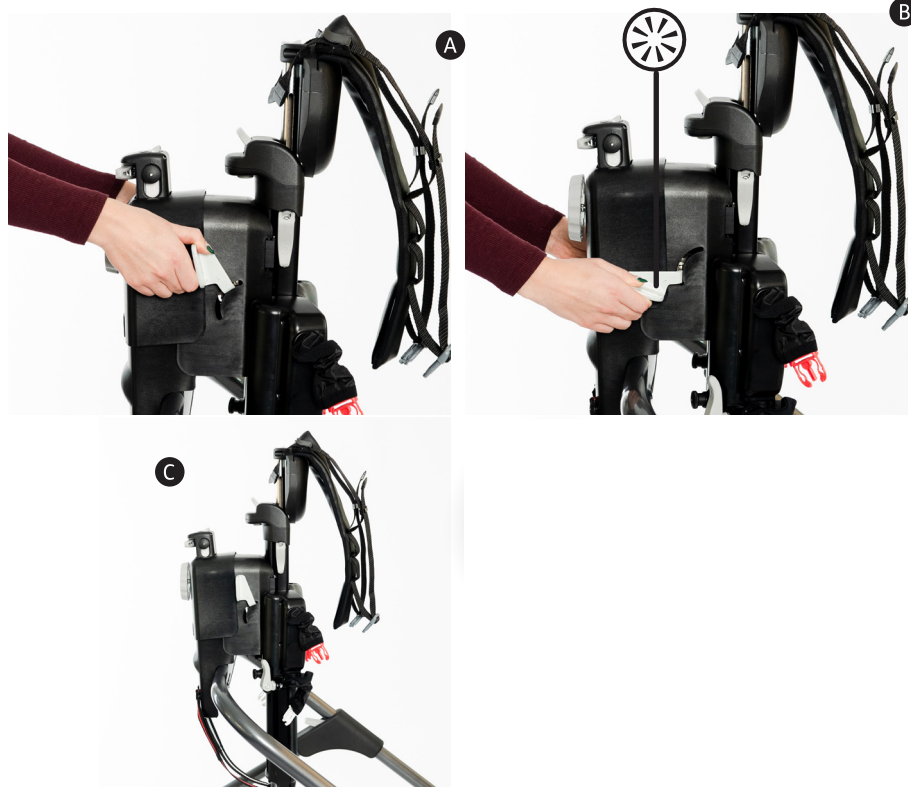

Note – fine height can only be used to increase height, it cannot be used to reduce height.

Note – if you find adjustment of the fine height challenging, ask the user if they can support some of their weight if possible, or, ask another person to help and support some of the user's body weight.

9.11 Upper Support Unit Adjustments | Prone Angle

- To increase prone angle, turn the knob in an anti-clockwise direction. Up to 10° of angle adjustment can be achieved. **A**
- To decrease prone angle, turn the knob in a clockwise direction. **B**

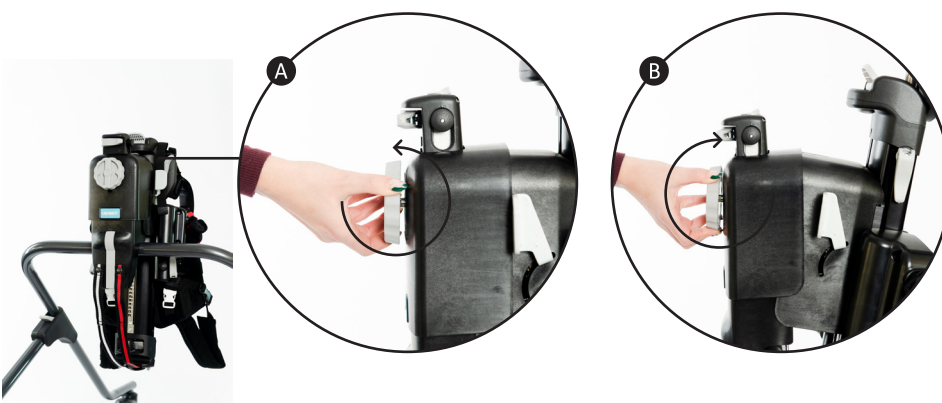

Warning – once the prone angle adjustment knob reaches its limit in either a clockwise or anti-clockwise direction, do not force the knob any further.



Note – if you find adjustment of the prone angle challenging, ask the user if they can support some of their weight if possible, or, ask another person to help and support some of the user's body weight.

Note – prone angle can be adjusted with the user in the product.

9.12 Upper Support Unit Adjustments | Overall Height Adjustment



- To adjust overall height place your index finger on the button **A** and push up. Then place your thumb on the lever **B** and press down. The spine will then move up and down - once you have achieved the desired position, release the lever and button. Once the button and lever are triggered, you may need to lift slightly upwards before the spine will adjust.



Note – in order to operate the overall height adjustment, the fine height handles need to be in their vertical, folded-away position. Overall height cannot be adjusted if these handles are facing outwards (horizontal).



Warning – do not adjust overall height whilst the user is in the product.

9.13 Upper Support Unit Adjustments | Adjustment of the Harness Connection Points

- There is a button above each of the pulley straps – each button corresponds to the strap below it. Each strap also corresponds to the matching coloured buckles i.e. the red strap corresponds to the red buckles and the white strap corresponds to the white buckles. The straps control the buckle positioning. **A**

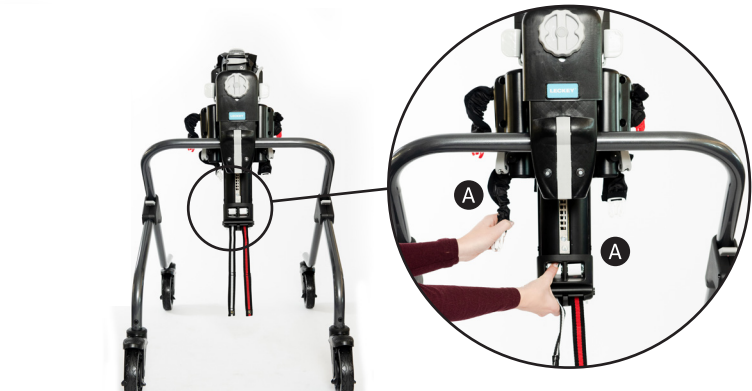

- To release the straps and buckles, push one of the buttons **A** and pull a corresponding buckle. **B** You only need to pull one side to release both buckles of the same colour **C**. Then repeat the process using the other button. The straps and buckles are now ready for the harness to be attached to the frame.



Continued →

9.14 Upper Support Unit Adjustments | Adjustment of the Harness Connection Points

- Once the child is in the frame and the harness has been attached to the upper support unit by the buckles (see section 10.5 'Attaching the harness to the frame'), pull each pulley strap to adjust the buckle straps and pull the child/harness closer to the frame.

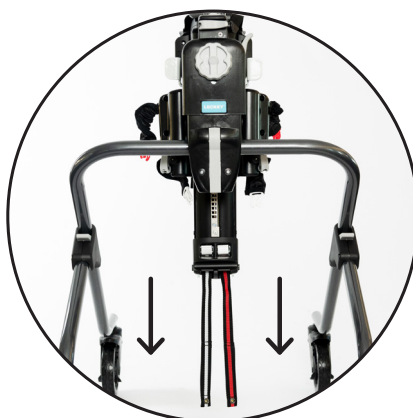

- If the frame is at a low height and the pulley straps are hanging down, you can attach them to the clips at the bottom of the frame- this ensures the straps are out of the way.

If you are using the product with a larger child and the buckles do not need much adjustment, the straps may hang at a height where it isn't possible to attach them to the bottom of the frame- this is not a cause for concern, the straps do not need to be clipped up if they are not in the way.

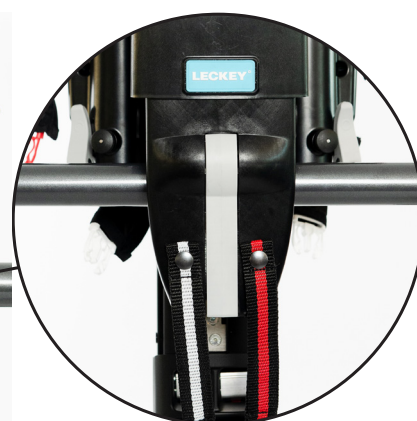

Warning – Only pull the pulley straps by placing hands in the loops- do not use feet.

When attaching the harness to the frame, ensure all four connection points are attached.



Note – a fair amount of force is required to pull the pulley straps. If you find adjustment challenging, ask the user if they can support some of their weight if possible, or support the user using a hoist.

9.15 Upper Support Unit Adjustments | Shoulder Height Adjustment

- Flip the grey lever up **A**, slide the shoulder unit up/down until the desired position is achieved.



- Once the shoulder unit is in the desired position, flip the grey lever down again to lock.

10.0 Harness Set-Up/Features



Warning – a risk assessment should be carried out to ensure that the correct size of harness is used.

10.1 Preparing the Harness

- Lie the harness out flat (with coloured buckles facing upwards) on a flat surface e.g. plinth. The harness should be opened to its furthest point by releasing the corset pull at the centre back. **A**



- The stripe belt strap can be folded back and fastened onto the Velcro- this holds the belt in place and ensures there are no obstructions when donning the harness. **A**



- Turn the harness over (the coloured inside should be facing upwards) and ensure the groin straps are lying out straight. The harness is now ready to use.



10.2 Donning the Harness | In Lying

- Position the user on a plinth in a side lying position. **A**
- Place the harness under the user using a rolling technique, with the lower edge of the harness just over the top of the pelvis (by about 2-3cm). The user should be lying in the centre of the open harness once you have finished positioning the harness. **B**



- Overlap the harness to secure it around the user's waist by a minimum of 8-10cm, ensuring the overlapping edges are straight. The coloured tab serves as an indicator to show if the outer wrap is in the correct position. **A**
- Connect the groin straps securely using the black buckles. **B**
- Adjust tautness as required by pulling the black straps on the groin strap.



- Release the stripe belt strap **A**, pull across the user's front and secure to increase the support around their trunk and create a 'hug' effect. **B**
- Connect the straps situated above and below the striped belt using the black buckles **C** Adjust the strap length if required.
- Check that the harness is containing the top of the user's pelvis whilst permitting hip movement.



10.3 Donning the Harness | In Supported Standing



Warning – Donning the harness in supported standing may only be possible if the user can take their own weight through their legs.

- Sit the user on a chair, perched and facing you against a support e.g. sofa or plinth. **A**
- Overlap the harness to secure it around the user's waist by a minimum of 8-10cm, ensuring the overlapping edges are straight. The coloured tab serves as an indicator to show if the outer wrap is in the correct position. **B**

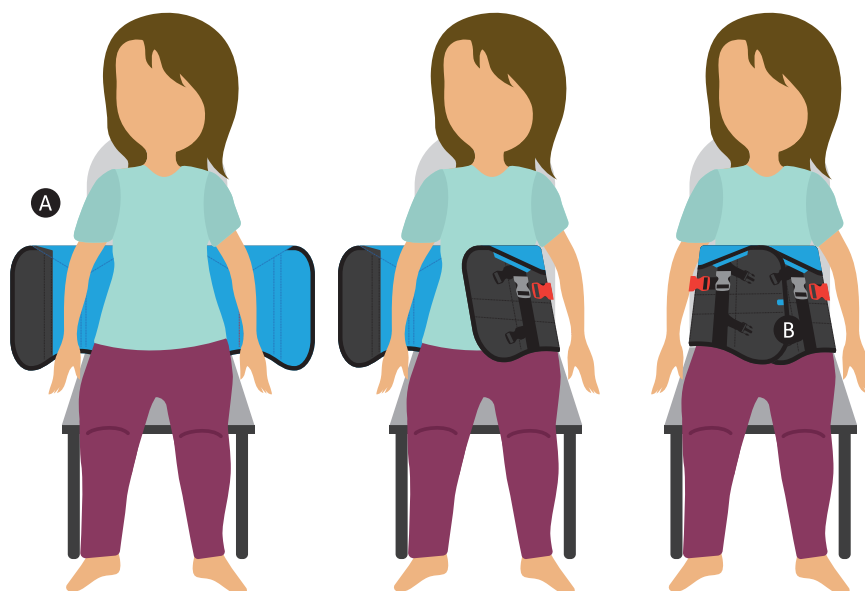

- Connect the groin straps securely using the black buckles. Adjust tautness as required by pulling the black straps. **A**
- Release the stripe belt strap, pull across the user's front and secure to increase the support around their trunk and create a 'hug' effect. **B**
- Connect the straps situated above and below the stripe belt strap. Secure the black buckles **C**. Adjust the strap length if required.
- Check that the harness is containing the top of the user's pelvis whilst permitting hip movement.

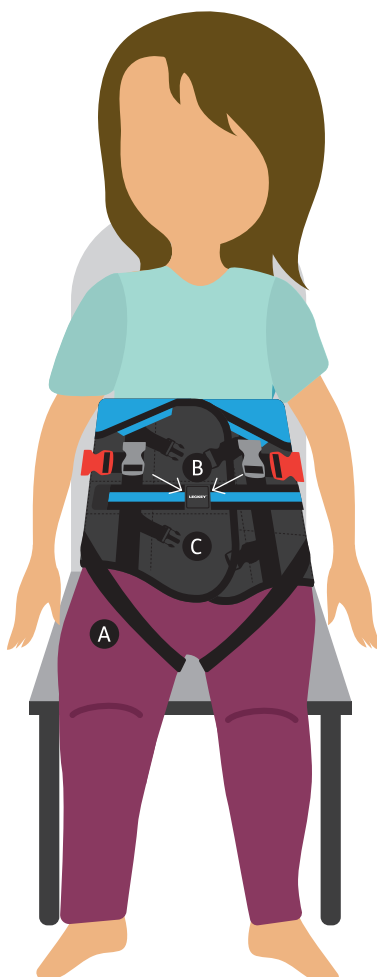

Warning – if the harness slips during use it may not be properly secured. Start the process of donning the harness again rather than trying to correct this when the user is upright.

Regular precautionary checks are advised to assess the user during/after use of the harness with regard to potential skin irritation.

Precautionary checks are advised to assess the user during/after use of the device in the unlikely event they may experience compromised respiratory function.

Never leave a user unattended whilst on a plinth.

Never use a damaged or badly worn harness.

10.4 Transferring the user to/from the frame



Warning – When transferring the user to/from the device, normal moving and handling procedures should be adhered to.

Two carers are required for transfers.

Standing Transfer to the Frame:

- One carer stands facing the user whilst holding their hands. **A**
- A second carer brings the frame into position from behind the user. **B**
- Attach the harness to the frame - **see section 10.5 'Attaching harness to the frame'** for instructions. The user will be standing or perching on the optional saddle accessory whilst this is done.

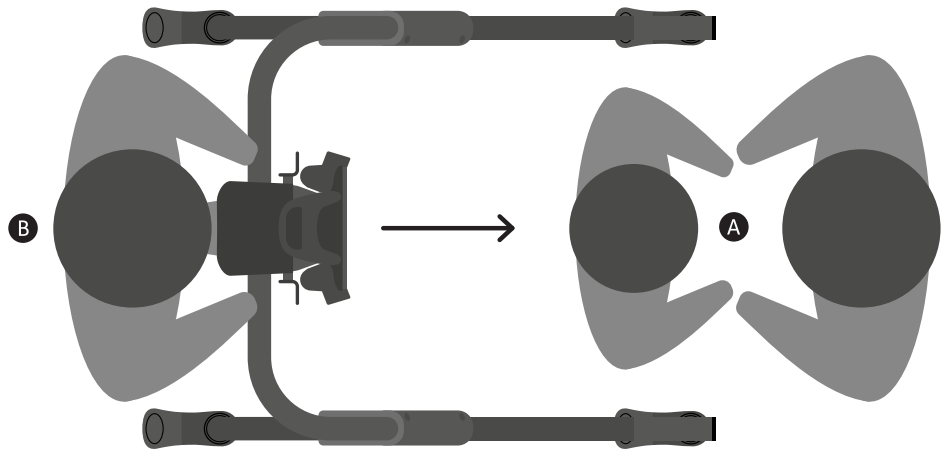

Standing Transfer out of the Frame:

- For a direct release from harness, the user should hold one carer's hands **A** whilst the harness is being opened.

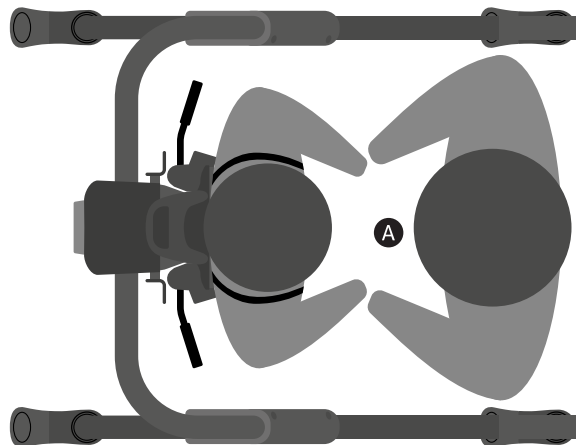

Warning – the optional user handles accessory should be removed for transfers in and out of the product and should not be used to assist with transfers.

- Release the grey shoulder strap buckles on the harness.

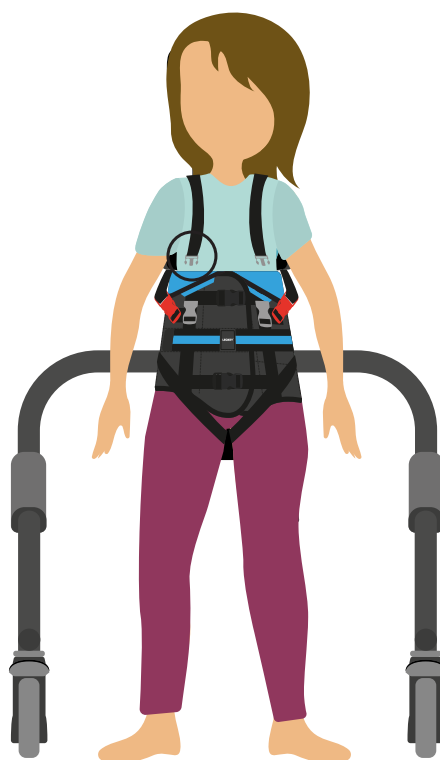

- Release the black groin strap buckles on the harness.

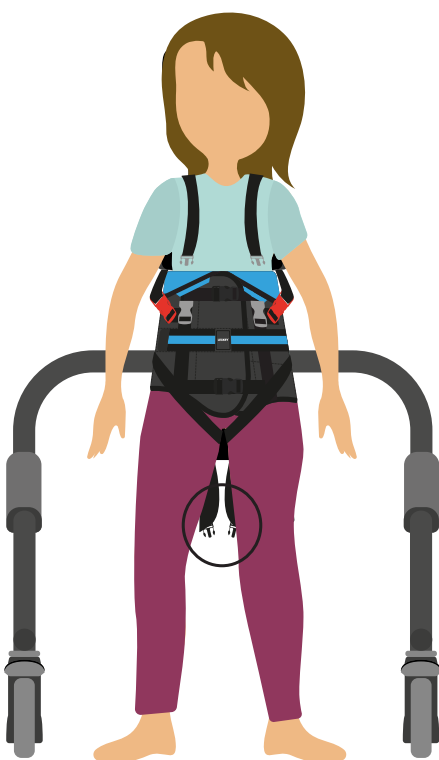

- Release the black buckles situated above and below the striped belt.

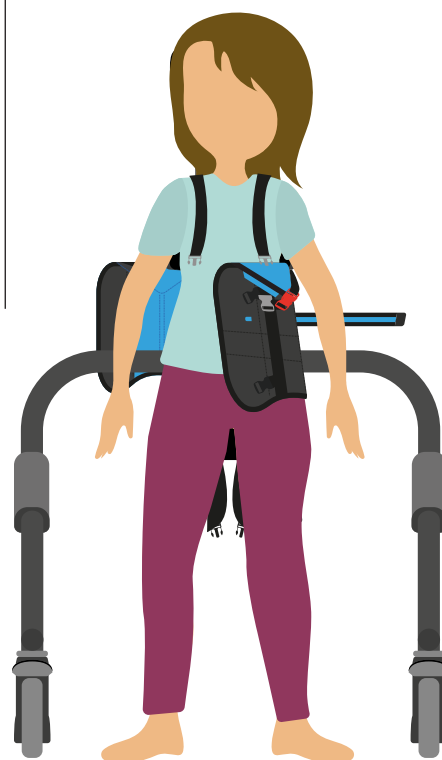

- Assist the user to step away from the harness and frame. **A**
- A second carer moves the frame away from behind the user. **B**
- Remove the harness from the frame - see section 10.6 'Detaching harness from the frame' for instructions.

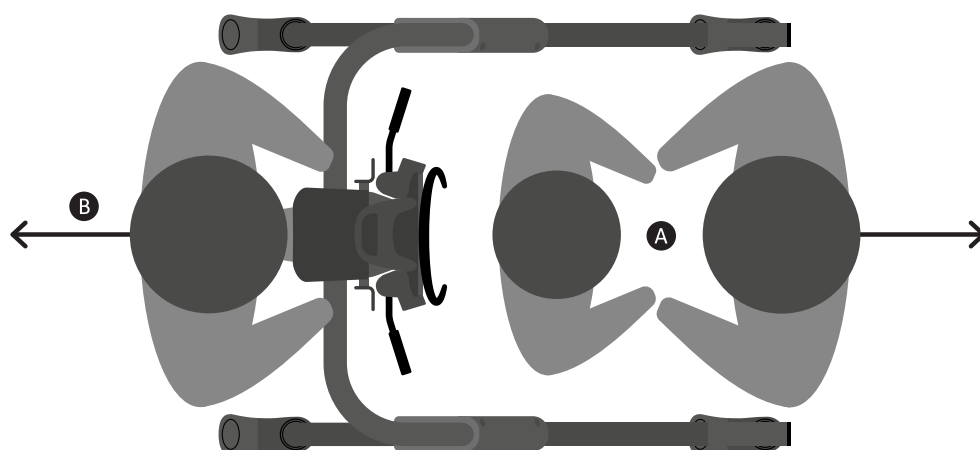

Hoisting Transfer to the Frame:

- Position the user in lying or perched sitting with support on the edge of a plinth.
- Attach the hoist straps to the harness using the two hoisting points situated on both the front and back of the harness- **see section 11.6 'Hoisting Straps' for instructions.**
- Connect the straps to the hoist.
- The first carer operates the hoist and guides the user into a suitable position for attaching the harness to the frame. The user should be supported by the hoist until this position is secured.
- The second carer attaches the harness to the frame- **see section 10.5 'Attaching harness to the frame' for instructions.**
- Remove the hoisting straps from the harness - **see section 10.6 'Hoisting Straps' for instructions.**

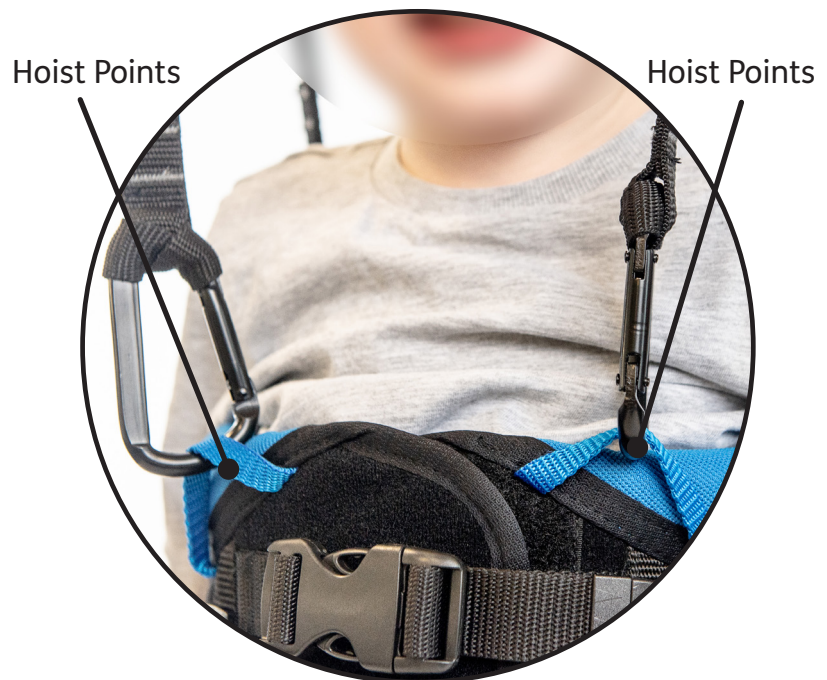

Hoisting Transfer out of the Frame:

- Attach the hoisting straps to the harness- **see section 11.6 'Hoisting Straps'** for instructions- and connect the straps to the hoist.
- Raise the hoist until the hoisting straps are taut. **A**
- Release the grey shoulder strap buckles on the harness. **B**
- Release the red **C** and white buckles **D** on the harness- this disconnects the harness from the harness connection point straps on the frame.
- Transfer the user to their chair or plinth.
- Remove the hoisting straps from the harness - **see section 11.6 'Hoisting Straps'** for instructions.



For instructions on how to remove the harness from the user, see section 10.7 'Removing the harness'.



Warning – The harness complies with LOLER (lifting operations and lifting equipment regulations). It is the caregiver's responsibility to adhere to these regulations when hoisting.

Ensure all relevant straps are attached/secured in the correct positions before beginning to hoist.

10.5 Attaching the Harness to the Frame

- First, ensure the harness connection points have been loosened as per instructions in **section 9.13 ‘Adjustment of the Harness Connection Points’**.
- Ensure the frame brakes and direction lock have been applied- **see section 9.6 ‘Applying/releasing brakes’ for instructions**.
- Transfer the user to the frame - **see section 10.4 ‘Transferring the harness to the frame’ for instructions**.
- Connect the white clips on the harness connection point straps to the white buckles on the harness (both sides) first. **A**
- Connect the red clips on the harness connection point straps to the red buckles on the harness (both sides). **B**
- Once the four straps and buckles have been connected, the pulley straps can be pulled to adjust the user’s position to the frame i.e. bring them closer to the frame if required. Ensure the harness connection point straps are taut- if the straps feel a little slack, they need to be brought in further by pulling the pulley straps. **A**



Warning – If necessary, ensure the user is supported whilst buckles are fastened either by attaching and using the saddle, or via help of another person.

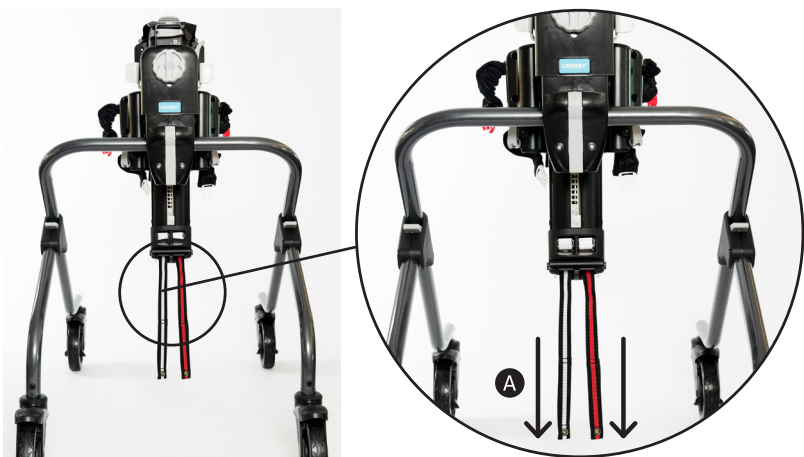



Warning – Ensure all four straps and buckles on the upper support unit and harness have been connected.

- Adjust the shoulder height, as per instructions in **section 9.14 'Shoulder Height Adjustment'**. The top of the shoulder straps should be level with the user's shoulders. **A**



- Place the shoulder straps over the user's chest and connect the grey clips on the straps into the grey buckles on the harness. Adjust as required by pulling the straps until they are taut. **B**

- If there is a gap between the user's shoulder area and the top of the shoulder straps **A**, release the black clips on the shoulder straps and pull the straps to adjust. Close the clip once the desired position has been achieved. **B**

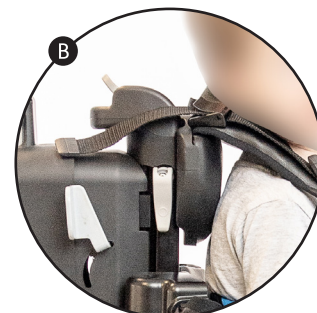

- If, after the harness has been attached to the frame, the user appears to be slipping through the straps, the shoulder straps can be positioned across the user's body. Cross the shoulder straps across the front of the user's body in an 'X' shape then clip each strap into the buckle on the harness which would be on the opposite side from when the shoulder straps and harness are connected in the standard set up.



Note – if the user needs to be removed from the product quickly e.g. Due to a seizure/spasm in product, release all coloured buckles.



Warning – This device is not intended for all day use but as part of a therapy programme. It is recommended that the device is not used for more than one hour during any session.



Warning – the carer must assess whether there is appropriate clearance of the shoulder straps from the user's neck if positioning straps as described above to avoid any strangulation risk.

10.6 Detaching the harness from the frame

- Ensure the frame brakes have been applied- **see section 9.6 ‘Applying/ releasing brakes’ for instructions.**
- Disconnect the grey clips on the shoulder straps from the grey buckles on the harness. Flip the straps backwards over the user’s shoulders. **A**
- Disconnect the red clips on the harness connection point straps from the red buckles on the harness (both sides). **B**
- Disconnect the white clips on the harness connection point straps from the white buckles on the harness (both sides). **C**



- Transfer the user out of the frame – **see section 10.4 ‘Transferring the harness out of the frame’ for instructions.**



Warning – if necessary, ensure the user is supported whilst buckles are disconnected either by attaching and using the optional saddle accessory, or via help of another person.

10.7 Removing the Harness

In Wheelchair Sitting

- Disconnect the groin straps by releasing the black buckles. Transfer the user’s weight from side to side to release the straps from under the user’s thighs. **A**
- Release the black buckles situated above and below the striped belt. **B**
- Release the stripe belt strap. **C**
- Open the harness wrap. **D**
- Lean the user forwards and slide the harness upwards from behind to remove.

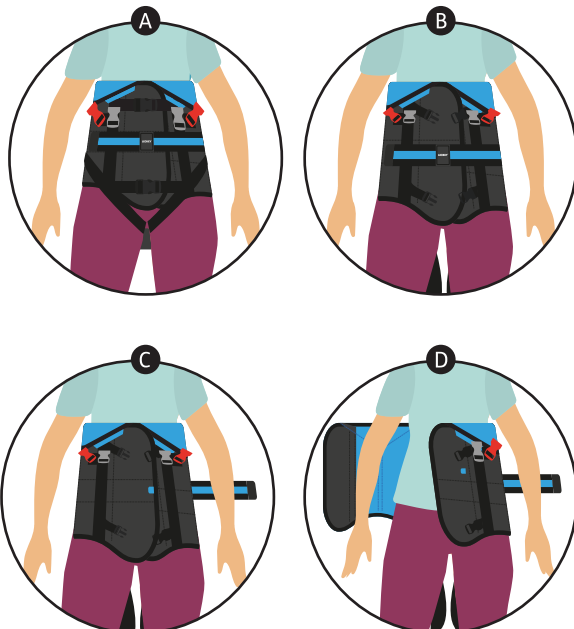

11.0 Accessories Set-Up/Features

11.1 Adult Handles

- The adult handles **A** connect to the frame via the handle receiver **B**
- To attach the adult handles, firstly ensure the grey clamping lever **C** is open
- Then lift the rubber cap **D** out of the receiver housing **B**
- Insert adult handles ensuring the alignment pin **E** is facing away from the clamping lever
- Once attached ensure the safety button **F** is in an inward position and no red markings are visible
- Then close the grey clamping lever **C**
- To adjust the height of the adult handle depress height adjust trigger **G** and rotate handles to the desired position, then release trigger.
- To remove the adult handles open the grey clamping lever **C**
- After this pull out release safety button **F**
- Then lift adult handles out of the handle receiver



Note – do not rotate the handles towards the child's head as they may clash.

Do not hang items on the adult handles as this may cause the product to become unstable.



Warning – be aware of finger placement when attaching/ detaching the adult handles to avoid potential for finger nipping. The adult handles should not be used to lift the device.

Be aware of others within the environment where the device is being used and avoid the adult handles making contact with them.

11.2 Headrest

- To attach the headrest, flip up the rubber cap situated on the top of the upper support unit to expose the headrest receiver slot. **A**
- Insert the headrest attachment pole into the receiver slot, then turn the handle in a clockwise direction. **B** Check the headrest is secure.
- To detach the headrest, turn the handle in an anti-clockwise direction to unsecure the headrest. Remove the headrest attachment pole from the receiver slot. Close the rubber cap situated on the top of the upper support unit.
- To adjust headrest height the headrest must not be attached to the product. Unscrew both knobs and remove them from the back of the headrest. **C** Move the headrest attachment pole to the desired position- there are 3 positions to choose from- and reattach the knobs in this position. Attach the headrest as per instructions above. **D**

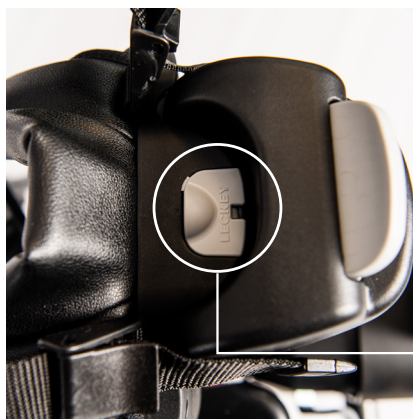

Note – when adjusting headrest height, take care not to move/turn the handle on the headrest attachment pole as this will make attaching the headrest to the frame difficult.



Warning – Be aware of finger placement when attaching/detaching the headrest to avoid potential for finger nipping.

11.3 Complex Head Rest

- To attach the head support, flip up the rubber cap **C** situated on the top of the upper support unit to expose the headrest receiver slot
- Insert the headrest attachment pole **A** into the receiver slot **B**, ensure silver headrest attachment pole curves away from the user. Loosen the thumb screws **E** and rotate the headrest backwards. Turn the attachment screw **D** in a clockwise direction. Check the headrest is secure. Rotate the headrest forward and tighten the thumb screws **E**.
- Use lateral screws **G** to adjust head support laterals. It is necessary to open the zip on the cover to access screws **G**. It is recommended to loosen both the screw **F** and the thumb screws **E** to position the headrest. When the headrest is at the desired position then tighten screw **F** and thumb screws **E**.
- To remove the headrest loosen the thumb screws **E** rotate the headrest backwards to allow access to attachment screw **D**. Turn the attachment screw **D** anticlockwise and lift the headrest up out of the receiver slot **B**.

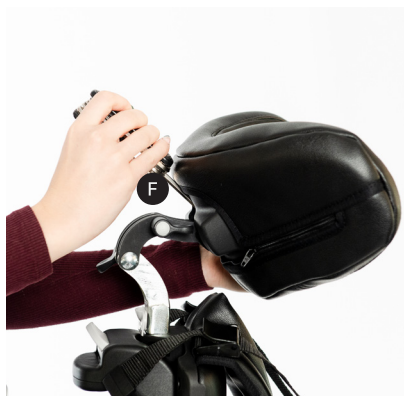

11.4 User Handles

- To attach the basic user handles, ensure the safety button **A** is in the out position and release the grey lever. **B**
- Slide the handle **C** into the receiver tube **D** and feed it upwards. Position handle to desired height using guide marks **E**.
- Once located, ensure safety button **A** is in the inwards position with no red markings visible. Then move grey lever **B** upwards.



Note – the safety button may need to be rotated to allow it to return to its inward position.

To remove the user handles firmly grip the user handles with one hand. Release the grey lever **B** and pull out the safety button **A** (red indicator will be displayed). Lower the user handles and remove from the main frame.



Note – if a user continually seeks out the frame in order to hold onto the tubing, it is recommended that the user handles are ordered and used.



Warning – be aware of finger placement when attaching/detaching the user handles to avoid potential for finger nipping.

User handles should be removed for transfers in and out of the product and should not be used to assist with transfers.

Be aware of others within the environment where the device is being used and avoid the user handles making contact with them.

11.5 Complex User Handles

- To attach the complex user handles, ensure the safety button A is in the out position and release the grey lever B.
- Gripping the foam grip C slide handles into the receiver tube D and feed it upwards. Position handle to desired height using guide marks E.
- Once located, ensure safety button A is in the inwards position with no red markings visible. Then move grey lever B upwards.
- To remove the complex user handles firmly grip the user handles with one hand C. Release the grey lever B and pull out the safety button A (red indicator will be displayed). Lower the user handles and remove from the main frame.

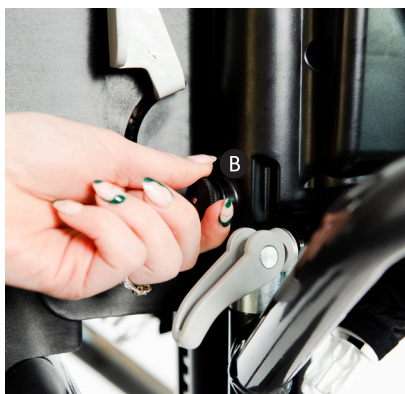

11.6 Complex User Handles (Adjustment)

To adjust the complex user handles accessory forwards and backwards, use the tool provided to adjust the screw **F** and tighten once in the desired position.

The complex user handles uses a combination of a 3D ball joint and rotary wheel to achieve additional adjustments to forward/backward movement as well as width and 3D positioning. It is recommended to loosen both adjustment **H** and **G** and position the user's arm as desired. Once achieved simply tighten these adjustment screws in place.

Additional forearm adjustment is achieved using adjustment adjustment knob **I**



Note – there is a slot in the arm wraps to access this screw for adjustment.

The hand grip can be rotated and height adjusted using adjustment screw **J**

Arm wraps **K** are attached by placing the wrap furthest from the child first and then placing the wrap closest to the child last **K**.



11.7 Saddle

- The saddle attaches into the dip in the plastic moulding. **A**
- Firstly, feed the pulley straps through the saddle. If this is not done the straps will cause an obstruction. **B**
- Move the saddle upwards so it is in a vertical position and hook the saddle bar into the dip in the plastic moulding. **A**
- Pull the lever outwards at the end of the saddle and move the saddle forwards and upwards, continuing to pull the lever outwards. **C**
- Bring the saddle to its final position, then release the lever. Check the saddle has been securely connected in at this stage. There is an indicator to the side of the saddle **D** - if the indicator shows green the saddle has been connected securely; if the indicator shows red the saddle has not been connected properly and this must be done again.
- To detach the saddle, pull the lever fully outwards **C**. Keep the lever pulled out as you swing the saddle downwards and it detaches.



Warning – Use both hands when attaching/detaching the saddle. Be aware of finger placement when attaching/detaching the saddle to avoid potential for finger nipping.

Our recommended protocol is to perch the child on the saddle prior to the harness being attached to the frame.

For users who have medical devices within/through the abdominal wall e.g. Pegs, baclofen pump, it is recommend that the saddle is kept in place during use. This reduces the likelihood of the harness riding up and causing discomfort or injury.

The device's frame should be moved/controlled by placing hands on the frame tubing or using the adult handles accessory only. Do not attempt to move/control the frame using the upper support unit or any other accessory.

11.8 Saddle Drop

To attach the saddle drop, insert guide pivot pin **A** through pivot slot **B** and rotate the rear of the saddle drop upwards. A click will be heard once the grey trigger **D** snaps onto the locking pin within the saddle.

To remove drop simple release trigger **D** and rotate the saddle drop downward, guiding pivot pin **A** out of the pivot slot **B**.



11.9 Ankle Guides

- To attach the ankle guides, feed the cord loop over the front castor, hooking it into the crevice between the castor and the frame tube. **A**
- At the opposite end of the ankle guide cord, remove the knob from the screw, feed the screw through the hole in the frame tube **B** and reattach the knob, tightening to the desired level. **C**



Note: on size 1 the knob and screw feed through a plate as shown



The ankle guide pad labels indicate whether they are for use on the left or right hand side of the user-attach the correct pad to the ankle guide using the buckle. The distance between the pad and the frame tube can be lengthened/shortened by adjusting the black strap. **A**

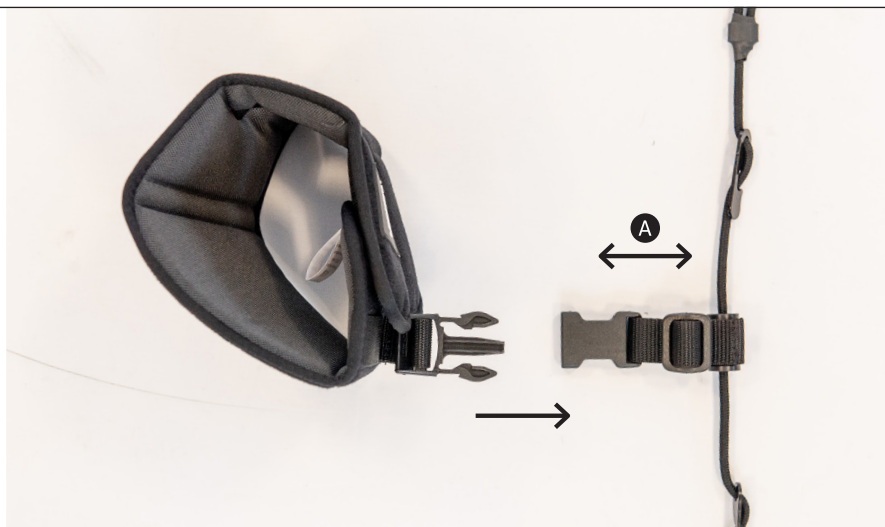

- Undo the Velcro tabs on the ankle guide pad and fit to the user. **A** The two-piece tab should be secured over the top of the one-piece tab. **B**
- There are sliders on the ankle guides which can be used to limit the amount of movement the user can make along the guide cord. **C**

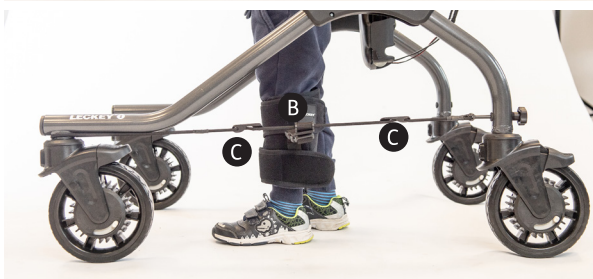

- To adjust the sliders, slacken the ankle guide cord by loosening the knob at the end of the frame tube **A**; unclip the sliders and move them to the desired positions **B**; clip the sliders over the ankle guide cord and re-tighten using the knob at the end of the frame tube. **C**
- Repeat steps above with the other ankle guide and pad.

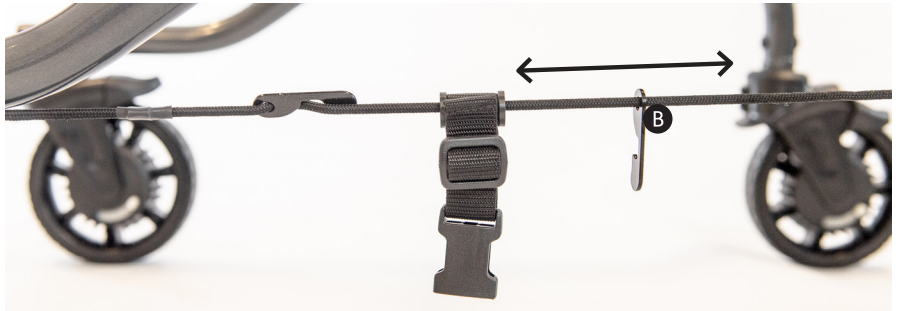
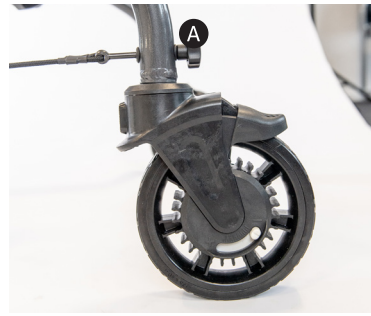

- To detach the ankle guides, release the ankle guide pad from around the user **A** and loosen the knob at the end of the frame tube to pull the screw out through the hole. **B** Unloop the ankle guide from the crevice between the front castor and frame tube. **C** Repeat with the other pad and ankle guide.



Warning – be aware of finger placement when attaching/detaching the ankle guides to avoid potential for finger nipping.

11.10 Hoisting Straps

- To attach the hoist straps, start with one side of the harness e.g. the left hand side.

Attach one carabiner to the front loop on the harness, then attach the second carabiner to the corresponding back loop. Repeat the process on the opposite side of the harness with the second hoist strap.

- To remove the hoist straps, detach the carabiner attached to the front loop on the harness, then detach the second carabiner on the corresponding back loop. Repeat the process on the opposite side of the harness with the second hoist strap.



Left Side

Right Side



Warning – Always ensure both hoist straps are used. Never attempt to hoist using just one strap.

Warning – Each hoist strap must be attached front and back on one side of the harness. The hoist straps should never be attached to both hoisting points situated at the front or back of the harness.

12.0 Typical Set-Up Order

12.1 Height Adjustment

- Set the frame height based on inside leg measurement. See section 9.12 'Overall Height Adjustment' for full instructions. If the user has fixed flexion deformities of knees and/or hips, measure the inside leg directly from hip to ankle, bypassing the knee, to ensure that the user is positioned to operate MyWay+ within their active range of lower limb movement.
- Note that the fine height adjustment does not lower the user within the frame. Therefore, initially position the child in a slightly lower position if fine tuning is required.
- Note that when the user is tilted forwards using the prone angle adjustment, the user loses height. Therefore use the fine height adjustment to raise the child again if the prone angle feature is used. See section 9.10 'Fine Height Adjustment' for full instructions.

12.2 Harness preparation and don

- See sections 10.2 'Donning the harness in lying' or 10.3 'Donning the harness in supported standing'

12.3 Transfer to Frame

- See section 10.4 'Transferring the harness to/out of the frame' and 10.5 'Attaching the harness to the frame' for full instructions.

12.4 Shoulder height and supports

- See section 9.15 'Shoulder Height Adjustment' for full instructions.

12.5 Prone angle adjustment

- If the user has difficulty initiating stepping, tilt the user forwards. Note the loss of height as the prone angle is adjusted. Use fine height adjustment to raise the child as required.
- See sections 9.10 'Fine Height Adjustment' and 9.11 'Prone Angle Adjustment' for full instructions.

12.6 Castors

- Set direction as free or uni-direction, as appropriate for the user's steering ability. See section 9.7 'Direction lock feature' for full instructions.
- Set resistance as free or as required to ensure optimum steering and control of speed. See section 9.9 'Resistance feature' for full instructions.
- Set rear lock if the user tends to roll backwards. See section 9.8 'Anti-roll back feature' for full instructions.

12.7 Accessories

- **Adult Handles:** These are a useful adjunct to MyWay+ to enable carers to safely push and steer the device. See section 11.1 'Adult Handles' for full instructions.
- **Headrest:** If the user has limited head control and/or fluctuating muscle tone, ensure the headrest is in position prior to transferring the user into MyWay+. See section 11.3 'Headrest' for full instructions.
- **Complex Headrest:** If the user has limited head control and/or fluctuating tone, ensure the headrest is in position prior to transferring the user into MyWay+. See section 11.2 'Headrest' for full instructions.
- **User Handles:** If the user continually seeks out the frame in order to hold onto the tubing, it is recommended that the user handles used. See section 11.4 'User handles' for full instructions.
- **Complex user handles:** If the user has low tone in their trunk and requires upper limb support to help with head control and/or support of their upper limbs to help improve lower limb movement then the complex user handles may be used. See section 11.5 'Complex user handles' for full instruction.
- **Saddle:** This may be required to perch the user prior to attaching the harness to the frame. However, once positioned, the user may not require the saddle. This can be removed and the user takes their own weight with additional support from the harness and groin straps. See section 11.7 'Saddle' for full instructions.
- **Saddle Drop:** If the user tends to keep their thighs and knees close together, the drop can be attached to the saddle while the user is in the frame. See section 11.8 'Saddle Drop' for full instructions.
- **Ankle Guides:** Apply to guide lower limb movement away from scissoring or asymmetric stepping pattern. The guides may be applied further up the lower limb for more proximal support. See section 11.9 'Ankle Guides' for full instructions.
- **Hoist straps:** If the user requires hoisting into and out of the frame, use the hoisting straps. See section 11.10 'Hoisting straps' for full instructions.

13.0 Cleaning and Care Information

Harness

- The harness can be machine washed at **60°C on a gentle program.**

- 1) Lie the harness out flat, with coloured buckles facing upwards.
- 2) If the groin straps are connected to the black buckles, release the straps and connect them into the grey buckles-ensure this is done on both sides.



- 3) Fold the stripe belt strap back so it is fastened onto the Velcro, underneath the groin strap.



- 4) Fold the harness inwards, so the coloured inside is visible, and fasten the Velcro.



- 5) Place the harness inside the wash bag provided, pull the drawstring ties to close and tie them in a bow.



- **Do not tumble dry.**
- Most stains can be removed using a clean microfibre cloth and lukewarm water. This method of cleaning is more effective than a standard cloth, water and proprietary soap.

Microfibre consists of very fine threads of polyester and nylon that combine to form a single thread. One microfibre is 100 times thinner than a single strand of human hair. Microfibres are so small that they attach themselves to even the smallest, most microscopic dirt particles – ones that normal cloths crudely brush past. For these reasons dirt and dust are hoovered up by microfibre cloths. This is cleaning naturally without chemicals.

Microfibre cloths must always be clean as the dirt can stay locked inside the cloths fibres.

Washing in hot water will release any dirt particles being held.



Warning – It is recommended that the harness is stored flat when not in use.

14.0 Daily Product Inspection

Therapists, Parents & Carers

- Staining should be removed as quickly as possible.
- **Do not pre-soak** the harness and use only small quantities of detergent. The harness can be hand washed and we recommend that you use only warm water and a non-abrasive detergent.
- Hanging up to dry is preferable.
- Always ensure the harness is dry before use.

Metal and plastic components

- Soap and water or antibacterial spray can be used for daily cleaning.
- For deep cleaning a low pressure steam cleaner can be used.
- Do not use solvents to clean plastic or metal components.
- Make sure the product is dry before use.

We recommend that daily visual checks of the equipment are carried out by therapists, carers or parents to ensure the product is safe for use. The recommend daily checks are detailed below.

1. Check the upper support unit is securely attached to the frame (for Sizes 2 and 3 only).
2. Check all castors are moving freely and locking securely. Check brakes, direction lock, anti-roll back and resistance features are all working correctly.
3. Check prone angle, fine height, overall height and shoulder height adjustments are adjusting freely and locking securely where applicable.
4. Check the pulley straps for signs of wear and tear.
5. Check the harness connection point straps and buckles for signs of wear and tear.
6. Check the user's harness and all straps/buckles for signs of wear and tear.
7. Check the harness Velcro strip and brush off any fluff to ensure it secures firmly.
9. Check the harness hoisting points and hoisting straps for signs of wear and tear.
9. Check any accessories are attached securely.



Warning – If in any doubt to the continued safe use of your Leckey product or if any parts should fail, please cease using the product and contact our Customer Care team or your local dealer as soon as possible.

18.0 Technical Information

















	Size 1 Frame	Size 2 Frame	Size 3 Frame
Age (approx.)	1-5	4-11	9-16
User Shoulder Height (to floor) (mm)	590 – 870	870-1190	1070 – 1490
User Saddle Height (inside leg) (mm)	240 – 410	400-610	550 - 810
Max. User Weight (kg)	25	50	80
Frame Weight (kg)	14 (S1 frame and upper support unit do not separate)	7.5	11
Upper Support Unit Weight (kg)		10	11
Frame Width (mm)	570	670	720
Frame Length (mm)	840	930	1180

Harness Size	Age (Approx)	Waist at Navel Level (cm)	Max. User Weight (kg)	Colour
1	1-4	46-56	50kg	Purple
2	2-6	50-60	50kg	Green
3	5-9	55-65	50kg	Blue
4	8-12	60-70	80kg	Red
5	12-15	70-80	80kg	Orange
6	16-18	80-90	80kg	Grey



Warning – The maximum user weight for this product is determined by the combination of frame and harness sizes selected- the maximum user weight is the lower of these limits. For example, if a Size 3 frame and a Size 3 harness are selected, the maximum user weight is 50kg, as determined by the harness limit.

Table of Symbols

Symbol	Meaning
	Manufacturer
	Max occupancy weight
	Serial number
	Product code
	Read the Instructions for Use
	CE mark
	UKCA mark
	Medical Device
	Warning
	Date of Manufacture
	Latex free
	Unique Device Identification
	Machine wash- water temperature 40°C
	Do not bleach
	Do not tumble-dry
	Do not iron
	Do not dry-clean

19.0 Product & Accessory Codes

209-1600	Size 1 MyWay+ Frame
209-2600	Size 2 MyWay+ Frame
209-3600	Size 3 MyWay+ Frame
173-4100-04	Size 1 Purple MyWay+ Harness
173-4200-07	Size 2 Green MyWay+ Harness
173-4300-02	Size 3 Blue MyWay+ Harness
173-4400-09	Size 4 Red MyWay+ Harness
173-4500-06	Size 5 Orange MyWay+ Harness
173-4600-08	Size 6 Grey MyWay+ Harness
173-2671	Wide Saddle
209-1671	S1 Thin Saddle
209-2671	S2/3 Thin Saddle
209-1679	S1 Saddle Drop
209-2679	S2 Saddle Drop
209-3679	S3 Saddle Drop

209-1667	Size 1 User Handles(L&R)
209-2667	Size 2 User Handles(L&R)
209-3667	Size 3 User Handles(L&R)
209-1740	Size 1 Complex User Handles with Ball Grips(L&R)
209-2740	Size 2 Complex User Handles with Ball Grips(L&R)
209-3740	Size 3 Complex User Handles with Ball Grips(L&R)
209-1741	Cylinder Grips (Pair)
209-1700	Size 1 Ankle Guides (L&R)
209-2700	Size 2 Ankle Guides (L&R))
209-3700	Size 3 Ankle Guides (L&R))
173-1680	Headrest (one size)
209-1680	Complex Headrest (one size)
209-1691	Size 1 Adult Handles
209-2691	Size 2/3 Adult Handles
173-1800	Hoist Straps
