

JOHN BUNN®

VACUTECH™ 800 EV2

JB0112-016



Medical Equipment

Complies with EN60601-1 standards

User Manual

⚠ **Federal law (USA) restricts this device to sale by or on the order of a physician. This product should not be used unless the operator has been instructed by a qualified healthcare professional.**

⊗ **This device is for use by one person only; in order to avoid infection, do not share it.**

NOTE: Check ALL parts for shipping damage. If shipping damage is noted, DO NOT use. Contact your Graham-Field authorized distributor for further instruction.

NOTE: Do not use the Aspirator without first reading and understanding this manual! Save this manual for future use.

Contents

1. Safety Information	2
2. AC Power Source	3
3. Electrical	4
4. Introduction	4
5. Illustration of Important Parts	5
6. Setup	5
7. How to Operate Your John Bunn® Aspirator	6
8. Cleaning Instructions	7
9. Maintenance	8
10. Troubleshooting	9
11. Specifications / Classification	10
12. Limited Warranty	11

Graham-Field and **John Bunn** are registered trademarks, and **Vacutec** is a trademark, of GF Health Products, Inc.

Packaging, warranties, products, and specifications are subject to change without notice. GF Health Products, Inc. is not responsible for typographical errors.

© 2010 GF Health Products, Inc. All rights reserved.

1. SAFETY INFORMATION

When using electrical products, especially when children are present, basic safety precautions should always be followed. Read all instructions before using. Please note the following special statements, used throughout this manual, and their significance:

⚠ DANGER: Indicates an imminent hazard situation that, if not avoided, will result in death or serious personal injury.

⚠ WARNING: Indicates a potential hazard situation that, if not avoided, could result in death or serious personal injury.

▲ CAUTION: Indicates a potential hazard or unsafe practice that, if not avoided, could result in product or property damage.

NOTE: Provides application recommendations or other useful information to ensure that you get the most from your product.

READ THIS ENTIRE MANUAL BEFORE USING THE ASPIRATOR.

SAVE THIS MANUAL

⚠ DANGER:

To reduce the risk of electrocution:

1. Do not use while bathing.
2. Do not place or store product where it can fall or be pulled into a tub or sink.
3. Do not place in or drop into water or other liquid.
4. Do not reach for a product that has fallen into water . Unplug immediately.

⚠ WARNING:

To reduce the risk of burns, electrocution, fire or personal injury:

1. Close supervision is necessary when this product is used by , on, or near children or those who need extra care.
2. Use this product only for its intended use as described in this guide.
3. Never operate this product if:
 - a. It has a damaged power cord or plug.
 - b. It is not working properly.
 - c. It has been dropped or damaged.
 - d. It has been dropped into water.
4. Return the product to a Graham-Field authorized distributor for examination and repair .
5. Keep the power cord away from heated surfaces.
6. Never use while drowsy or asleep.
7. This device is for use by one person only; in order to avoid infection, do not share it.

⚠ SPECIFIC WARNINGS:

TO REDUCE THE RISK OF ELECTRICAL SHOCK OR PERSONAL INJURY, DO NOT DISASSEMBLE THIS UNIT. Disassembly or attempted repairs, if accomplished incorrectly, can create electrical shock hazard. Only qualified technicians should perform servicing of this aspirator. Contact your Graham-Field authorized distributor for service.

⚠ DANGER:

The John Bunn® Vacutec™ 800 EV2 Aspirator is a vacuum suction device intended for the collection of nonflammable fluid materials in medical applications only . Improper use during medical applications can cause injury or death.

For all medical applications:

1. All suctioning should be done in strict accordance with appropriate procedures that have been established by a licensed medical authority.
2. Some attachments or accessories may not fit the tubing supplied. All attachments or accessories should be checked prior to use to assure proper fit.

2. AC POWER SOURCE

▲ CAUTION: The Model JB0112-016 uses a power supply allowing operation on AC voltage (115 VAC, 60 Hz). However, the correct power source must be used to connect to adaptable wall power. Before use, check the specification label on the side of the aspirator to ensure that the voltage and current indicated on the unit match the voltage and current available.

3. ELECTRICAL

Compressor

If the overload protector shuts off the motor frequently, you may have a low voltage situation. Low voltage can also be suspected when:

1. The motor does not get up to full power or speed.
2. Other motor-operated appliances fail to operate properly. Too many motor-operated appliances on same circuit.

NOTE: *The aspirator's compressor motor has a thermal overload protector. If the motor overheats, the overload protector will shut off the motor. If this occurs, turn the ON/OFF switch to the OFF position and allow the motor to cool (approximately 5 minutes). Restart aspirator. If the aspirator fails to start, wait an additional 5 minutes before attempting to restart. If this fails, inspect your aspirator fuse (and replace if necessary). If the unit still does not restart, contact your Graham-Field authorized distributor immediately.*

⚠ WARNING: Proper operation of this product is necessary to avoid physical harm. Improper use can cause personal injury and/or tissue damage. This product should not be used unless the operator has been instructed by a physician or another qualified healthcare professional.

1. Familiarize yourself with this unit.
2. Place unit on table and push down hard so that suction feet hold unit firmly in place.
3. Before plugging power cord into electrical outlet, ensure the ON/OFF switch is in the OFF position.

NOTE: *Before attempting to start a cold unit, let the unit reach room temperature in a heated area.*

4. INTRODUCTION

The John Bunn® Vacutec™ 800 EV2 Aspirator is a professional medical suction device that produces a maximum vacuum of 560 mmHg. The unit is equipped with an 800 cc collection bottle and has been designed for convenient and reliable use.

Features:

- HEPA filter design helps prevent contamination
- Mid-size aspirator for medium-duty use
- Quiet and compact, quick recovery time
- Automatic shut-off
- Designed for single-patient use
- Oil-free, permanent lubrication
- High reliability and superior performance allow continuous operation

Following the recommended operating and maintenance procedures outlined in this user manual will maximize the life of this product. Refer to the diagrams on the following pages.

5. ILLUSTRATION OF IMPORTANT PARTS



Figure 1



Figure 2

6. SETUP

1. Connect both pieces of tubing:
 - a. Connect one end of tubing a to the top of the collection bottle connector and the other end to the bacteria HEPA filter, as shown in Figure 1.
 - b. Connect one end of tubing b to the open end of the bacteria HEPA filter and the other end to the vacuum gauge, as shown in Figure 1.
2. Connect the suction tubing to the top of the collection bottle at the outlet labeled “patient”, as shown in Figure 2. Ensure that all connections are secure and without leaks before use.
3. Before use, check the specification label on the side of the aspirator to ensure that the voltage and current indicated on the unit match the voltage and current available. Make sure the ON/OFF switch shown in Figure 2 is in the OFF position before connecting the unit to a power source.

⚠ **Read SETUP WARNINGS before continuing.**

⚠ **SETUP WARNINGS:**

1. This device is equipped with a three-prong (grounding) plug for protection against possible shock hazard. Plug only into a properly grounded three-prong wall receptacle. Where a two-prong wall receptacle is encountered, contact a licensed professional to have the two-prong receptacle replaced with a properly grounded three-prong wall receptacle in accordance with the National Electrical Code. **DO NOT** modify the plug in any way.
2. If an extension cord must be used, use a three-conductor cord with the same or higher electrical rating as the aspirator cord, with ground, properly wired, in good electrical condition, and keep it as short as possible.
3. Locate all cords so that they will not be stepped on, tripped over, or otherwise subjected to damage or stress.

7. HOW TO OPERATE YOUR JOHN BUNN® ASPIRATOR

1. Make sure the ON/OFF switch located on the side of the unit is in the OFF position. Plug the aspirator into a properly grounded power outlet.

2. Switch the ON/OFF switch to "I" position (ON); the unit will start running.

Figure 3

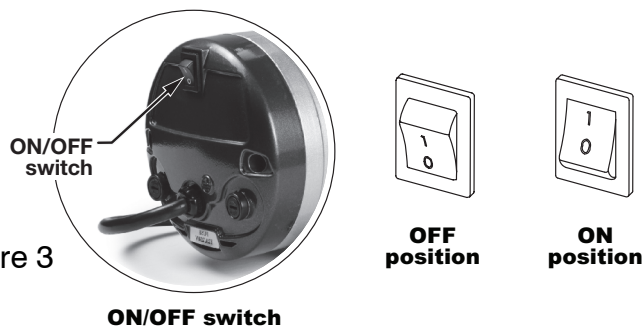

3. Adjust the vacuum level from 0 to 560 mmHg by turning the vacuum adjust knob (clockwise to increase vacuum and counter-clockwise to decrease vacuum). Refer to the vacuum gauge while setting the desired level of vacuum. To accurately read the gauge, block the patient end of the hose or cap off the collection bottle and allow the gauge to reach a stable vacuum reading.

Figure 4

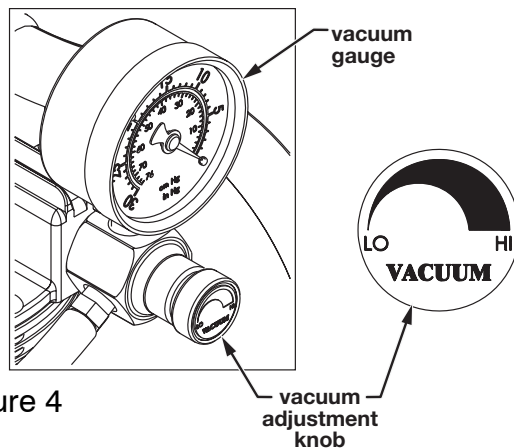

4. Position the suction tubing appropriately for patient and begin suction.

Figure 5

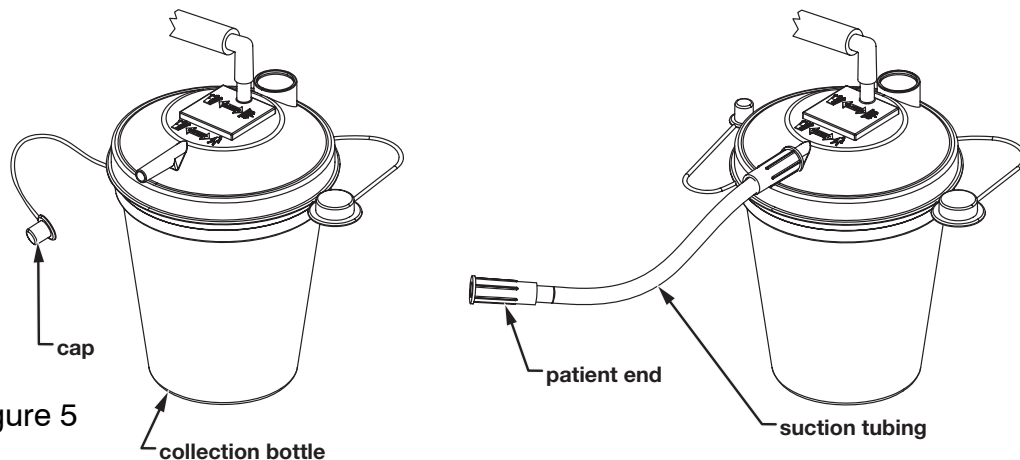

5. When the liquid in the collection bottle reaches the safe full level (800 cc), the float shut-off will activate automatically and suctioning will stop.

Figure 6

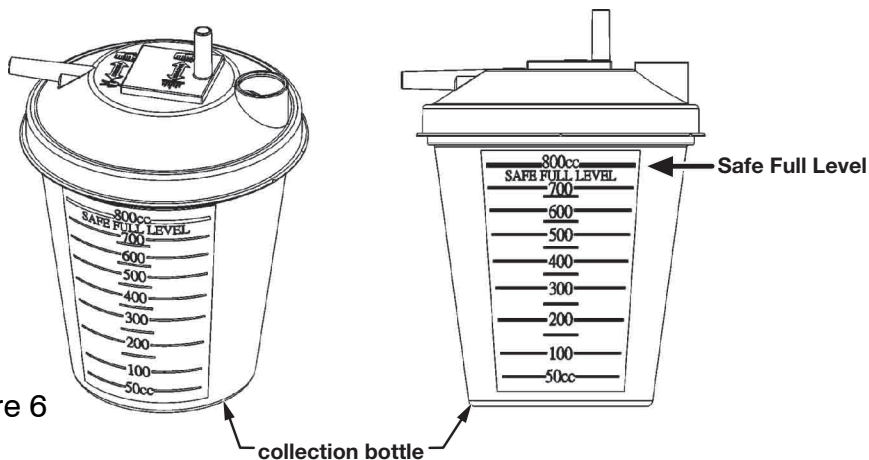

6. Switch the ON/OFF switch to the OFF position to shut off the suction motor .
7. Unplug the aspirator when not in use.
8. Remove the liquid from the collection bottle after the motor stops turning completely . (Please refer to the following “CLEANING INSTRUCTIONS” section for directions to clean the collection bottle).
9. Switch the ON/OFF switch to the ON position and start to run the aspirator again.

NOTE:

1. *If the unit sustains a severe drop, the validity of the gauge must be checked. Inspect the float shut-off to ensure it still functions properly when the liquid in the collection bottle reaches the safe full level.*
2. *Always transport unit with vacuum adjust knob rotated fully clockwise in case the unit is dropped.*

▲ CAUTION:

1. **When automatic float shut-off is activated, empty the contents of the collection bottle immediately. Further suction could cause damage to the vacuum pump.**
2. **Should fluid be aspirated back into the unit, contact your Graham-Field authorized distributor for a detailed inspection, as the vacuum pump may have been damaged.**

8. CLEANING INSTRUCTIONS

Clean Collection Bottle:

1. Turn off the aspirator, allow vacuum to drop, then disconnect AC power source.
2. With the collection bottle still in the holder, remove the collection bottle lid. The bottle can now be taken out of the holder to be emptied.

NOTE: Empty the collection bottle immediately after each use.

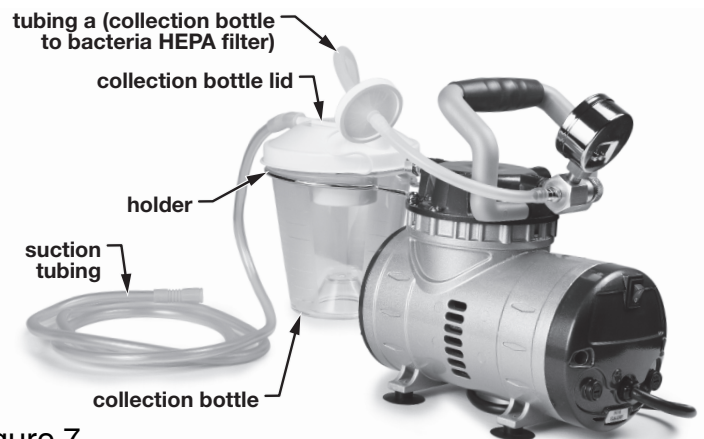

Figure 7

3. Clean the collection bottle after each use by using one of the following three methods:
 - a. Wash in a hot water/dishwashing detergent solution and rinse with clean, hot tap water . Then wash in one part vinegar to three parts hot water solution. Rinse with hot tap water and air dry .
 - b. Wash with rubbing alcohol and air dry.
 - c. Wash with a commercial (bacterial-germicidal) disinfectant; follow disinfectant manufacturer's recommended instructions and dilution rates carefully.

Clean Aspirator and Collection Bottle Lid:

1. Disconnect the aspirator from all external power sources.
2. Wipe the aspirator housing and collection bottle lid with a clean cloth and any commercial (bacterial-germicidal) disinfectant.

▲ CAUTION: Do not submerge unit in water as this will result in severe damage to the vacuum pump.

Clean Tubing:

1. Disconnect the tubing from the unit.
2. Rinse the tubing thoroughly after every use by running hot tap water through it, followed by a solution of one part vinegar to three parts hot water .
3. Rinse with hot tap water and air dry .
4. Keep the outer surface of the tubing clean by wiping with a clean, damp cloth.

⚠ **WARNING:** The waste in the collection bottle, which could cause respiratory infection, must be handled according to medical waste disposal regulations. The operator must wear gloves and a medical-class mask before cleaning the collection bottle and tubing or handling the waste unit and/or accessories.

9. MAINTENANCE

Inspect suction tubing and collection bottle for leaks, cracks, etc. before each use. If found, discontinue aspirator use immediately and contact your Graham-Field authorized distributor .

⚠ **DANGER: Electric shock hazard**

Do not attempt to open or remove the suction cabinet. If service is required, contact your Graham-Field authorized distributor. Opening or tampering with the unit will void the warranty.

Bacteria HEPA Filter Change:

1. Replace the bacteria HEPA filter when either of the following two conditions occurs:
 - a. the filter is dirty and the aspirator has lost suction, or
 - b. there is liquid in the filter assembly as result of extended use or overflow . If overflow occurs, change the filter immediately.
2. Remove the filter by disconnecting it from the tubing connected to the vacuum gauge and the tubing connected to the collection bottle lid assembly.
3. Replace with a new John Bunn® bacteria HEPA filter and connect it to the tubing connected to the vacuum gauge and the tubing connected to the collection bottle lid assembly , as formerly positioned. Additional filters can be purchased from your Graham-Field authorized distributor .

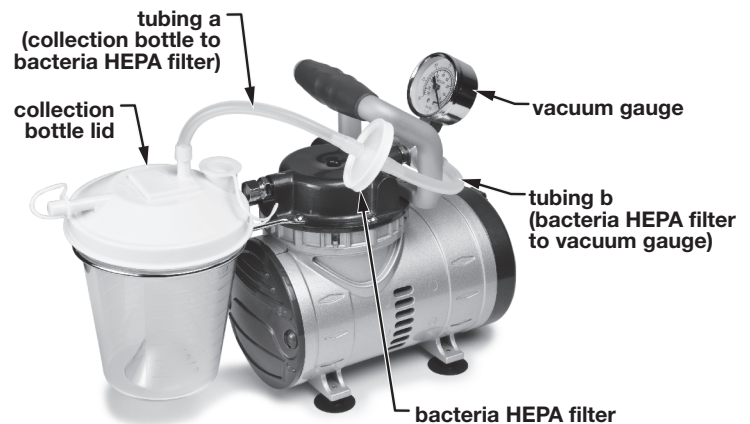

Figure 8

▲ **CAUTION:**

1. Failure to use filter or replace filter as needed will cause damage to the aspirator which is not covered under the warranty.
2. Use only John Bunn® filters. Do not substitute any other material for this bacteria HEP A filter. Improper substitution may lead to contamination or poor performance.

Fuse Change:

1. Use only the same type and size of fuse to replace the broken fuse.
2. Fuse specification: Miniature Glass Fuse 5x20mm, Fast Blow (Quick Acting), F2A/250V.

⚠ WARNING: When this unit or its accessories reach the end of their useful lives (dependent on conditions of use), residue in the collection bottle, tubing and filter could cause respiratory infection. Dispose of the collection bottle, tubing and filter appropriately according to medical waste disposal regulations.

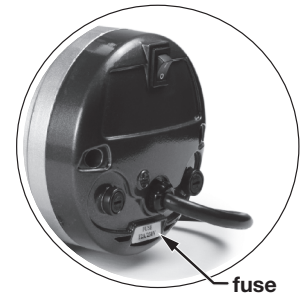

Figure 9

10. TROUBLESHOOTING

Your John Bunn® aspirator contains no user-serviceable parts. If you believe your unit is not working properly, **before you contact your Graham-Field authorized distributor for service**, please take a few moments to check for these possible causes:

PROBLEM	ACTION
Unit does not turn on	<ol style="list-style-type: none">1. Check power source and connection2. Ensure that the wall outlet is live3. Check power cord for damage
Motor runs, but no vacuum	<ol style="list-style-type: none">1. Verify tubing connection security2. Check for leaks or tubing kinks3. Ensure that float shut-off is not activated4. Check for bottle leaks and cracks
Low vacuum	<ol style="list-style-type: none">1. Use vacuum adjust knob to increase vacuum level2. Check system for leaks3. Adjust vacuum adjust knob and release
Motor overheats and motor overload protector shuts off motor	<ol style="list-style-type: none">1. Turn ON/OFF switch OFF, allow motor to cool for approximately 5 minutes, then restart aspirator2. Inspect fuse and replace if necessary3. Contact your GF authorized distributor if unit still does not start up
Blown fuse	Replace fuse with same size and type (Miniature glass fuse, 5 x 20 mm, fast blow (quick acting), F2A/250 V)

If you are unable to resolve the problem, please contact your Graham-Field authorized distributor .

11. SPECIFICATIONS * / CLASSIFICATION

Dimensions (L x W x H)	15.3 in x 4.9 in x 10 in (389 mm x 124 mm x 254 mm)
Weight	11.6 lb (5.3 kg)
Vacuum Range	0 - 560 mmHg
Operating Flow Range	0 - 40 LPM
Sound Level	< 55 dBA
Electrical Requirements	AC 115V 60Hz 1/16 hp
Power Consumption	60 watts
Bacteria Filter Type	HEPA
Bacteria Filter Pore Size	0.2 microns
Collection Bottle Capacity	800 cc
Operating Temperature	32° ~ 104° F (0° ~ 40°C)
Operating Humidity	95% RH
Operating Atmospheric Pressure	10.2 ~ 15.4 psi (70 ~106 kP a)
Storage Temperature	14° ~ 158° F (-10° ~ 70°C)
Storage Humidity	0 ~ 95% RH
Storage Atmospheric Pressure	7.3 ~ 15.4 psi (50 ~106 kP a)
Fuse Specification	Miniature glass fuse, 5 x 20 mm, fast blow (quick acting), F2A/250 V
Equipment Classification	Class I
Replacement Parts	JB0112-016F: Replacement bacteria HEPA filter
	JB0112-016B: Collection bottle
	JB0112-016S: Suction tube

* Specifications are subject to change without notice.

12. TWO-YEAR LIMITED WARRANTY

GF Health Products Inc. warrants the John Bunn® JB0112-016 Vacutec™ 800 EV2 Aspirator and its components to be free from defects in workmanship and materials for a period of two years. This warranty is extended only to the original purchaser/consumer or distributor/non-consumer of this new product and to no other purchaser or transferee.

The Warranty period for the consumer commences on the first date a product is delivered to consumer by seller/distributor. If the product is rented or leased, the warranty period commences on the invoice date from GF Health Products, Inc. A copy of the invoice showing date of purchase must be provided when submitting warranty claims. When proof of purchase date is not provided, warranty coverage shall commence upon GF Health Products, Inc.'s invoice date to the distributor/purchaser.

If within the warranty period, the product or component part is proven to GF Health Products, Inc.'s satisfaction to be defective, GF Health Products, Inc. shall provide, at its option, one of the following: (1) repair or replacement of any defective or nonconforming part or product or (2) a credit and/or refund of the original selling price. GF HEALTH PRODUCTS, INC.'S SOLE OBLIGATION AND YOUR EXCLUSIVE REMEDY UNDER THIS WARRANTY SHALL BE LIMITED TO SUCH REPAIR, REPLACEMENT, CREDIT AND/OR REFUND. This warranty does not include any labor charges incurred in replacement part(s) installation or any associated freight or shipping charges to the manufacturer.

For warranty service, please contact the authorized distributor from whom you acquired your GF Health Products, Inc. product. Upon receiving notice of an alleged defect in a product, GF Health Products, Inc. will issue a return authorization. The defective product or part(s) must then be returned, at the purchaser's cost, for warranty inspection using the serial number as identification (or, if the product is not serialized, lot number and date code) within thirty (30) days of return authorization issue date. In the event you do not receive satisfactory warranty service, please contact GF Health Products, Inc. at the address below. DO NOT return products to our factory without prior authorization.

LIMITATIONS AND EXCLUSIONS: The foregoing warranty excludes consumables, such as filters and tubing, as these require routine maintenance. The foregoing warranty shall not apply to serial numbered products if the serial number has been removed or defaced. Products subjected to negligence, abuse, misuse, improper operation, improper maintenance, improper cleaning, improper storage, or damages beyond GF Health Products, Inc.'s control are not covered by this warranty, and that evaluation shall be solely determined by GF Health Products, Inc. This warranty shall not apply to problems arising from normal wear and tear or failure to follow instructions. The warranty shall also not apply to products modified without GF Health Products, Inc.'s express written consent; nor shall it apply if parts not manufactured by GF Health Products, Inc., or if parts not complying with original equipment specifications are added to GF Health Products, Inc. products, or if the product or part is serviced by an entity not authorized by GF Health Products, Inc.

THE FOREGOING WARRANTY IS EXCLUSIVE AND IN LIEU OF ALL OTHER EXPRESS WARRANTIES AND IMPLIED WARRANTIES, INCLUDING BUT NOT LIMITED TO THE IMPLIED WARRANTIES OF MERCHANTABILITY AND FITNESS FOR A PARTICULAR PURPOSE, AND SHALL NOT EXTEND BEYOND THE DURATION OF THE EXPRESS WARRANTY PROVIDED HEREIN, AND THE REMEDY FOR VIOLATIONS OF ANY IMPLIED WARRANTY SHALL BE LIMITED TO THE REPAIR, REPLACEMENT, CREDIT AND/OR REFUND OF THE DEFECTIVE PRODUCT OR PART PURSUANT TO THE TERMS CONTAINED HEREIN. GF HEALTH PRODUCTS, INC. SHALL NOT BE LIABLE FOR ANY CONSEQUENTIAL OR INCIDENTAL DAMAGES WHATSOEVER.

This warranty gives you specific legal rights and you may also have other legal rights which vary from state to state (province to province). Some states (provinces) do not allow the exclusion or limitation of incidental or consequential damage, or limitation on how long an implied warranty lasts, so the above exclusion and limitations may not apply to you.

This warranty contains the entire agreement between the parties and supersedes any prior, contrary or additional representations or understandings, whether oral or written, concerning our warranty policy.

U.S.A. Corporate Headquarters:

