

OMRON®

INSTRUCTION MANUAL

IntelliSense® Blood Pressure Monitor



Model **HEM-907XL**



ENGLISH

INTRODUCTION

Thank you for purchasing the OMRON IntelliSense® Blood Pressure Monitor.



Please thoroughly read this Instruction Manual before using this monitor to ensure safe and accurate use.

Please keep this manual near the monitor all the time for future reference.

TABLE OF CONTENTS

Intended Use	4
--------------------	---

Be Sure to Read This Section

Exemptions.....	4
Notes on Safety.....	5

Know Your Unit

Features of the Product.....	9
Components of the Product	10
Features and Functions	11
Names of the Parts	11
Functions and setting while the unit is in use	13

Preparations before Measurement

How to Apply the Cuff	15
How to Use the Power Source.....	17
How to Use the AC Adapter.....	18
Installation and Replacement of Battery Pack	19

How to Measure Blood Pressure

List of Measurement Modes.....	20
SINGLE Mode	21
AVG Mode.....	23
MANU Mode.....	25
How to Check Pressure Accuracy	27
How to Clean the Unit after Use	28
List of Error Codes	29
Troubleshooting.....	30

Specifications

Caution	31
Five Year Limited Warranty	31
Specifications	32
FCC/ISED Statement	33

INTENDED USE

The device is a digital monitor intended for use in measuring blood pressure and pulse rate in adult patient population with arm circumference ranging from 7 inches to 20 inches (17 cm to 50 cm).

EXEMPTIONS



OMRON does not accept liability and warranty becomes void under the following circumstances:

1. When persons, not authorized by OMRON, perform repairs or modifications of this product.
2. When use and/or operation of this device is adversely effected by a device not manufactured by OMRON.
3. When use and/or operation of this device is adversely effected by use of parts, not authorized by OMRON, to repair or modify this product.
4. When Notes on Safety or Instructions for Use contained in this manual are not followed.
5. When use and/or operation of this device is effected by an act of nature, such as fire, earthquake, flood or other natural disasters.









1. The product and contents of this Instruction Manual may be changed without prior notice.
2. We have prepared the contents of this Instruction Manual thoroughly. However, if an inadequate description or error is found, please let us know.
3. Reproducing or copying any or all of this Instruction Manual without OMRON's written consent is prohibited.





NOTES ON SAFETY

- The warning signs and the sample icons shown here are listed to insure safe and accurate use.
- The icons and meanings are as follows.

Warning sign	Contents
 Warning	Indicates matters in which death or severe bodily damage may arise as a result of incorrect handling.
 Caution	Indicates matters in which bodily harm or material damage* may arise as a result of incorrect handling.





* Material damage refers to a wide range of damage involving your house, household goods, domestic animals, and pets.

Examples of signs	
	The  icon indicates caution (including warning and danger). Matters involving actual caution are indicated by text or pictures in or near  . The pictured icon refers to “caution for flammability”.
	The  icon indicates prohibitions (what you cannot do). Matters involving actual prohibitions are indicated by text or pictures in or near  . The pictured icon refers to “prohibition to disassemble”.
	The  icon indicates something that is compulsory (always follow). Matters involving actual compulsory actions are indicated by text or pictures in or near  . The pictured icon refers to “unplugging the power source plug”.

 Warning	
<p>Self diagnosis of measured results or treatment is dangerous. Please follow the instruction of the doctor or healthcare provider.</p> <p>Do not adjust medication based on measurement results from this blood pressure monitor. Take medication as prescribed by your physician. Only a physician is qualified to diagnose and treat High Blood Pressure.</p> <p>If cuff inflation does not stop, remove the cuff or pull out the air tube from the main unit.</p> <p>If battery fluid gets into your eye or comes in contact with skin, wash the effected area with water repeatedly. Immediately consult a doctor for treatment.</p>	
<p>Do not wrap the cuff over an arm to which intravenous injection or transfusion is being conducted, or when otherwise contraindicated.</p> <p>Do not connect the air tube or the cuff to other equipment which is connected to an intracorporeal organ. Air embolisms may result.</p>	
<p>Do not use this unit in the presence of flammable gas or anesthetics or in a high pressure oxygen room or oxygen tent.</p> <p>Do not use the battery pack for devices other than for this unit.</p> <p>Do not disassemble the battery pack.</p>	
<p>Do not touch the AC adapter with wet hands.</p>	

NOTES ON SAFETY

Caution

<p>Unplug the AC adapter from the electric outlet if this unit is unused for an extended period of time.</p> <p>Unplug the AC adapter from the electric outlet when installing, removing, or cleaning the unit.</p>	
<p>Confirm readings with a stethoscope when an irregular pulse wave is displayed or when the measured value is questionable or erratic.</p> <p>Use an AC adapter indicated for use with a power supply of 110 VAC.</p> <p>Do not share an electric outlet with other unit or electric appliance.</p> <p>After cleaning this unit, dry it well before plugging the AC adapter in the electric outlet.</p> <p>If this unit fails to perform as indicated, discontinue use, turn off the unit, unplug the AC adapter from the electric outlet, and contact OMRON's repair department.</p>	
<p>Do not disassemble or modify this unit.</p>	
<p>Do not use any cuff other than the models exclusive for this unit.</p> <p>Do not use this unit on infants.</p> <p>Do not use this unit on patients using a pump oxygenator.</p> <p>Do not use an AC adapter or battery pack not specified for this unit.</p>	

NOTES ON SAFETY

Caution

Do not use a cellular phone near this unit.
Do not use this unit in a vehicle.
Do not install the parts and/or instruments not specified for this unit.
Do not use a broken power cord or AC adapter.



Do not install or store this unit where it may come in contact with water or liquid medication.
This is a Class II device with double insulation.



General advice

Do not place or put anything on this unit.

Do not drop this unit.

Turn off power to the unit and unplug the AC adapter from the electric outlet before moving the unit.

Read the instruction manual of the other devices to be used at the same time with this unit, to understand and be aware of the interaction between the devices.

When using the unit

- Do not inflate the cuff without being wrapped over the arm.
- Do not use a damaged cuff.
- Be sure that patients do not touch the Buttons of this unit.

After using the unit

- Do not disinfect this unit by autoclave or gas sterilization (EtO, glutaraldehyde, or high concentration ozone).

Do not install or store this unit in the following places.

- Under the direct sunlight,
- Dusty or salty environment,
- Places having slope, vibration, and/or shock,
- Storage of chemicals or where combustable gas may be generated,
- Under high temperature and high humidity.

NOTES ON SAFETY

Maintenance and inspection

1. Check the unit operation on regular basis.
2. If this unit has not been used for more than three months, be sure to check that this unit operates normally and safely before use.

Troubleshooting

If device error 9 (Er9) occurs, take the following procedure promptly:

- (1) Remove the cuff from the patient's arm.
- (2) Turn off the power of the unit and unplug the AC adapter from the electric outlet.
- (3) Display "Out of use" on this unit so that it cannot be used.
- (4) Contact Omron Healthcare's Customer Service at 1-877-216-1336.

FEATURES OF THE PRODUCT

OMRON IntelliSense® Blood Pressure unit, Model HEM-907XL is developed to measure blood pressure and pulse rate accurately and simply in a doctor's office, examination room, or patient bedside.

- **One-button operation**

Simply wrap the cuff and push the START Button. Blood pressure and pulse rate are automatically measured by the oscillometric method.

- **Automatic pressure setting**

When the P-SET (Pressure Setting) Knob is set to "AUTO", the unit will automatically inflate the cuff to the optimal pressure according to each patient's blood pressure. Pre-setting inflation level is not necessary.

- **Noiseless operation**

This unit operates so quietly that it can be used in the patient room at night.

- **Average Mode (AVG Mode)**

In the AVG Mode, this unit will automatically measure for two or three times. The average of systolic and diastolic blood pressures and pulse rate are displayed. Each measurement can also be shown individually. The number of measurements, waiting time before first measurement, and the interval can be changed.

- **Auscultation Mode (MANU Mode)**

You can measure auscultatory blood pressure by using a stethoscope, with automatic cuff inflation and deflation by this unit. Because the cuff pressures during deflation are displayed digitally and synchronized with the heart beat, they can be read with accuracy. After taking systolic reading you can accelerate cuff deflation to shorten measurement time.

- **Large and easy to read display**

Large and easy to read figures are displayed on the LCD display.



The IntelliSense® Monitor inflates the cuff to the ideal level with each use. No adjustments are required by the user to select an inflation level. This is especially convenient for hypertensive users and for people with certain arrhythmia or heart disorders, because their blood pressure is likely to fluctuate. The advantage is Personalized Inflation for maximum comfort.

COMPONENTS OF THE PRODUCT

Main unit

IntelliSense® Blood Pressure Monitor, Model HEM-907XL

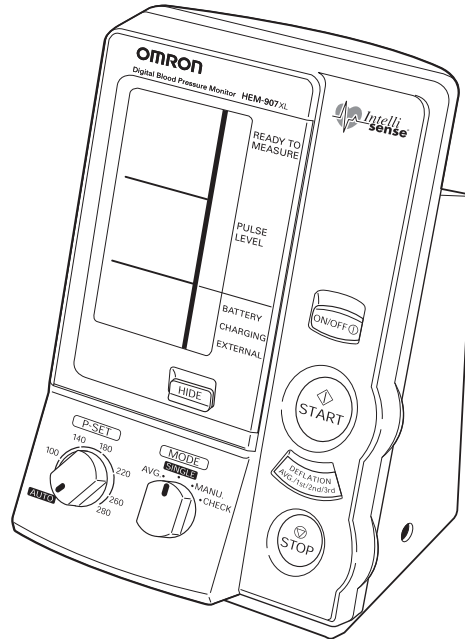

Accessories

(Included and also available separately)

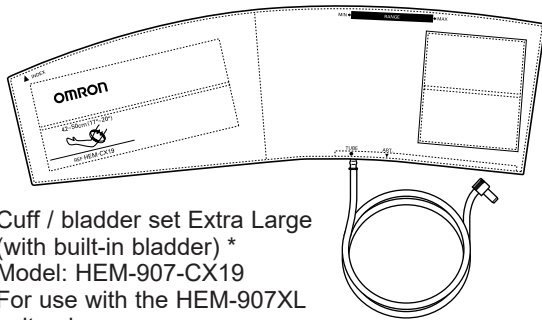

Cuff / bladder set Extra Large (with built-in bladder) *
Model: HEM-907-CX19
For use with the HEM-907XL unit only.
Applicable arm circumference: 17" to 20" (42 to 50 cm)

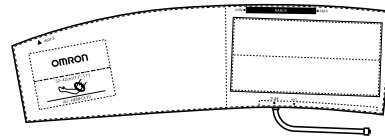

Cuff / bladder set Large (with built-in bladder) *
Model: HEM-907-CL19
Applicable arm circumference: 13" to 17" (32 to 42 cm)

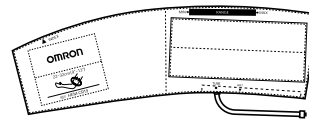

Cuff / bladder set Medium (with built-in bladder) *
Model: HEM-907-CR19
Applicable arm circumference: 9" to 13" (22 to 32 cm)

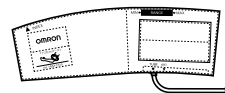

Cuff / bladder set Small (with built-in bladder) *
Model: HEM-907-CS19
Applicable arm circumference: 7" to 9" (17 to 22 cm)

AC adapter
Model: HEM-ADPT907

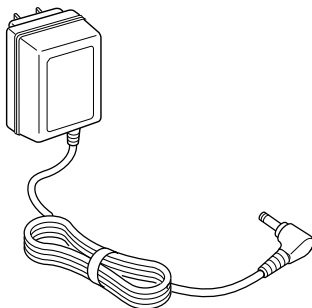

Air tube 1.3m (51 3/16") *
Model: HEM-TUBE-130XL

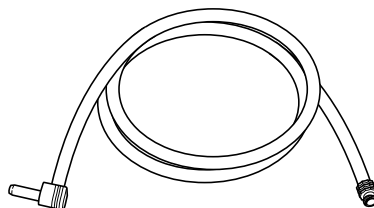

The air tube is available for the large, medium or small cuff size. It is NOT for use with the extra-large cuff size.

Battery pack (48H907N)
Model: HEM-907-PBAT

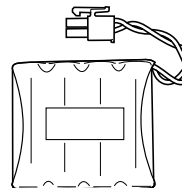

Instruction Manual



Items identified with an asterisk (*) are consumables and not covered by the guarantee.

FEATURES AND FUNCTIONS

Names of the Parts

Main unit

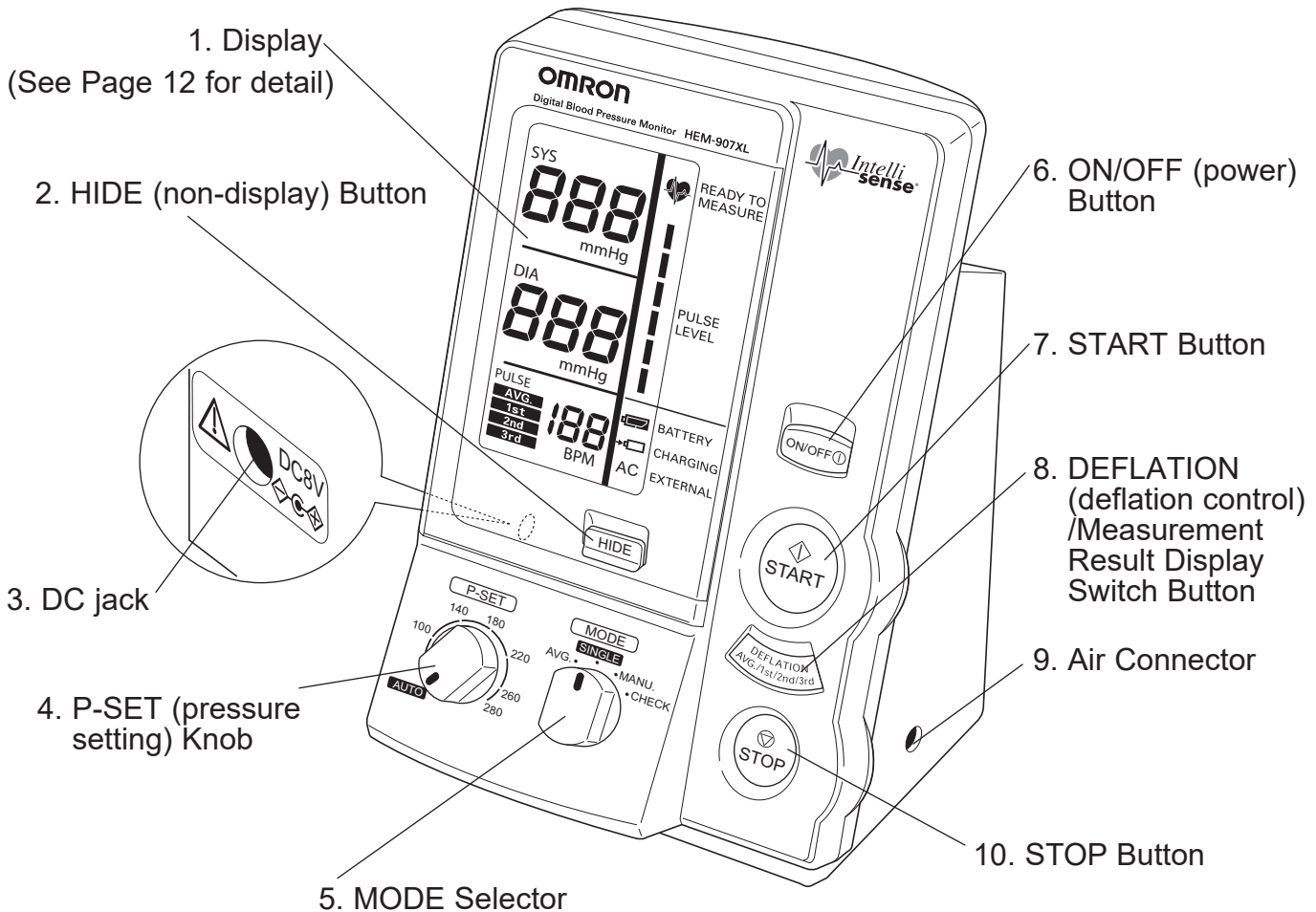

1. Display: Displays blood pressure and, pulse rate readings, and oscillation pulse level.

2. HIDE Button: Switches display and non-display of measured results.

3. DC jack: Connects the AC adapter.

4. P-SET (pressure setting) Knob: In the AUTO position, inflation level is automatically set. Otherwise, inflation level can optionally be set manually between 100 and 280 mmHg.

5. MODE Selector: Selects the operation mode.

- One-time Measurement Mode (SINGLE Mode): Measurement with automatic inflation.
- Average Mode (AVG Mode): Automatically measures two (or three) times consecutively.
- Auscultation Mode (MANU Mode): Automatic inflation, automatic deflation, and pressure display for auscultation (does not measure blood pressure).
- Check Mode (CHECK Mode): Checks the accuracy of pressure display. Displays only pressure.

6. ON/OFF (power) Button: Turns on or off the unit.

7. START Button: Starts the measurement.

8. DEFLATION (deflation control) /Measurement Result Display Switch Button:

- In the MANU Mode, deflates the cuff by approximately 5 to 10 mmHg with each push during deflation.
- In the AVG Mode, switches the display of average values and the measurement results with each push.

9. Air Connector: Connects the air tube.

10. STOP Button: Stops the measurement and deflates air rapidly.

FEATURES AND FUNCTIONS

Display

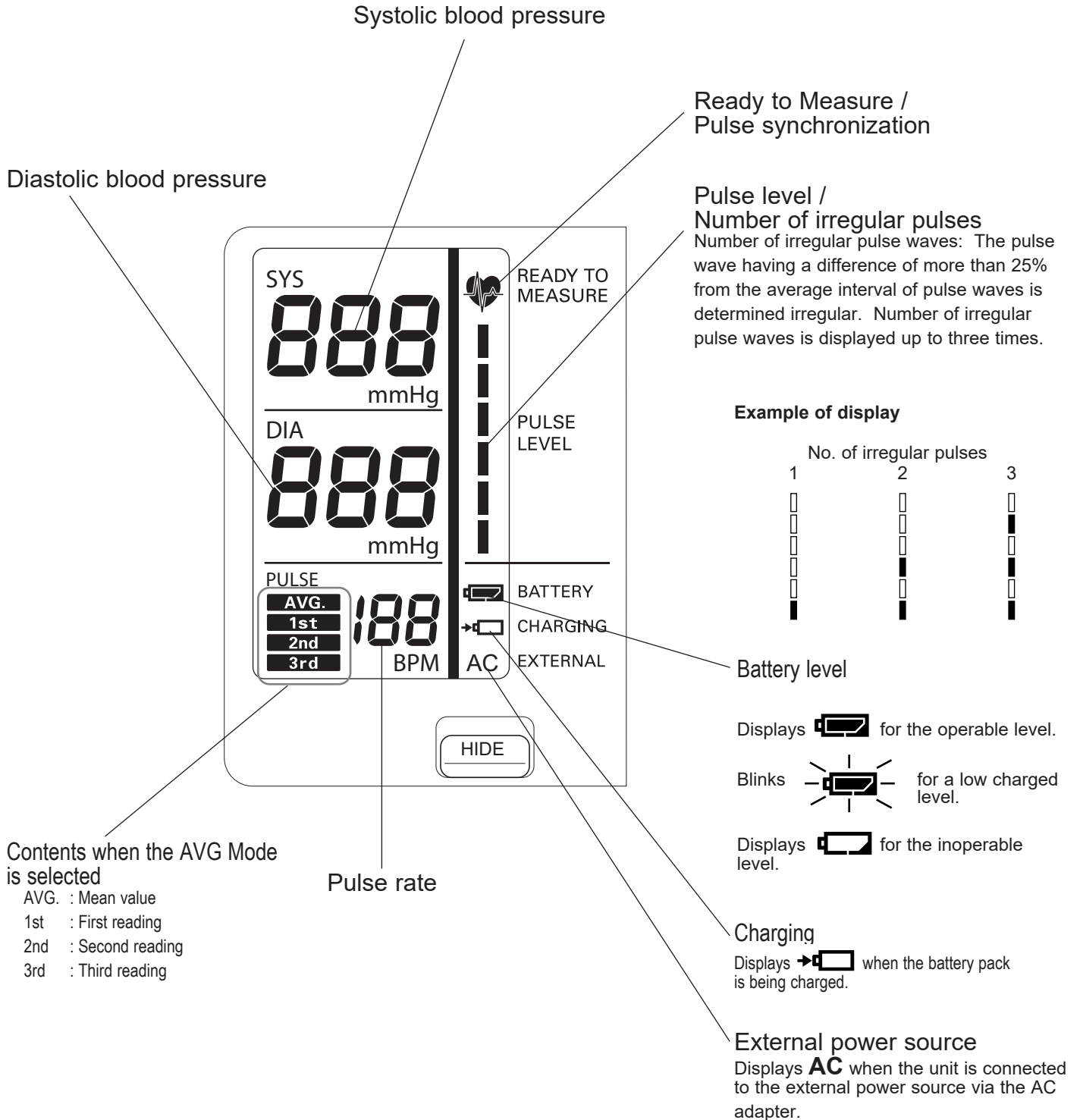

FEATURES AND FUNCTIONS

Functions setting

(1) Inflation level setting P-SET

AUTO (Automatic setting): Can be used when the SINGLE, AVG, or MANU Mode is selected. The unit estimates the systolic blood pressure during inflation and inflates to a proper cuff pressure (approximately 30-40 mmHg above the patient's systolic pressure).

Manual level setting: Inflation level can be set manually between 100 and 280 mmHg. Set the level to 30 to 40 mmHg higher than the expected systolic pressure.

- To set the P-SET to "AUTO", turn the P-SET Knob counterclockwise as far as it goes until you can hear a click.
- In the "AUTO" setting, inflation level may not be set automatically when the systolic blood pressure is more than 220 mmHg. Use the unit in the manual setting.
- If the cuff has not been inflated to the necessary level, it may be re-inflated automatically.

(2) Non-display function HIDE

Use to prohibit the display of measurement results. However, the cuff pressure during measurement is displayed. This function can be used in the SINGLE and AVG Modes.

By pushing the HIDE Button, display or non-display of status is switched alternatingly.

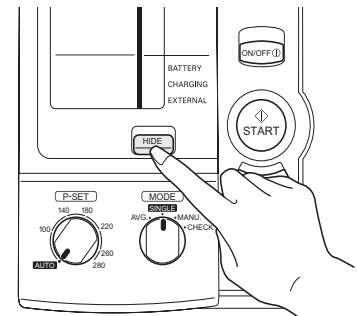
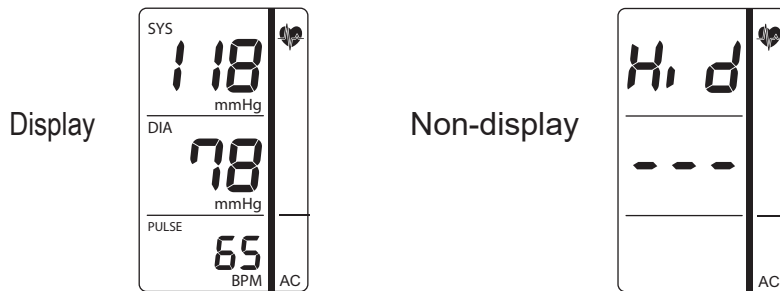

(3) Manual deflation control

DEFLATION
AVG./1st/2nd/3rd

Accelerate deflation by pushing the DEFLATION (deflation control) / Measurement Result Display Switch Button during deflation in the measurement by the MANU Mode.

With each push of the DEFLATION
AVG./1st/2nd/3rd Button, cuff is deflated rapidly in increments of 5 to 10 mmHg.

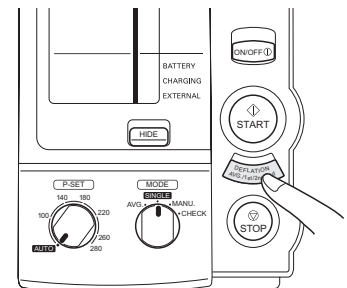

FEATURES AND FUNCTIONS

List of Functions for each Mode

Measurement Mode / Function	Single (SINGLE) Mode	Average (AVG) Mode	Auscultation (MANU) Mode	Check (CHECK) Mode
Inflation level setting	●	●	●	—
Non-display function	●	●	—	—
Manual deflation control	—	—	●	—

(4) AVG Function setting

You can set the number of measurements, the waiting time until the 1st measurement, and the measurement interval for the AVG Mode.

Function #	Items to set	Set value
F1	Number of measurements	2 times or 3 times
F2	Waiting time until the start of 1st measurement	0 sec , 3 min, 5 min, or 10 min.
F3	Measurement interval	5 sec, 30 sec, 1 min , or 2 min.

Note: The bold letters represent the factory-set values.

Procedure to change the set values

1) When the power is OFF, push the ON/OFF (power) Button for more than three seconds while holding the START Button; F1 is displayed.

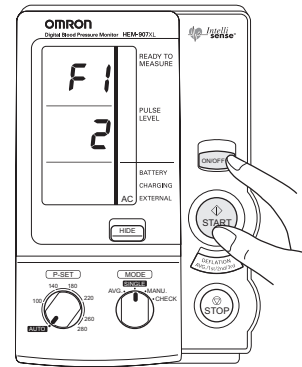

2) Push the START Button and select the function to set from F1 to F3. Each time you push the START Button, the functions change in the order of $F1 \rightarrow F2 \rightarrow F3$.

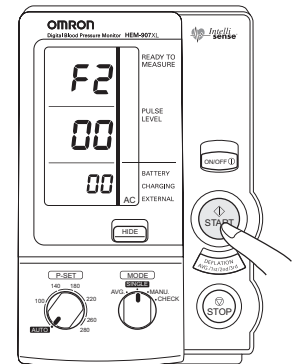

3) Push the DEFLATION (deflation control)/Measurement Result Display Switch Button and change the set values.

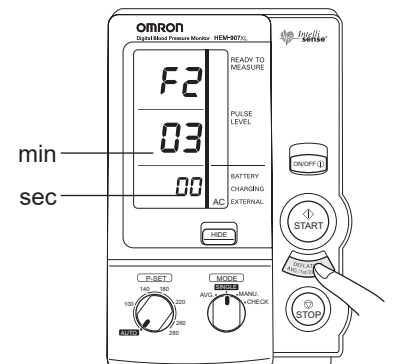

4) When the setting is finished, push the ON/OFF (power) Button to turn off the power. The setting is changed.

HOW TO APPLY THE CUFF

The cuff of OMRON IntelliSense® Blood Pressure Monitor HEM-907XL plays an important role of collecting the information on blood vessels. Please wrap the cuff according to the procedure, below.

Warning

Do not wrap the cuff over an arm to which intravenous injection or transfusion is being conducted, or when otherwise contraindicated.

Do not connect the air tube or the cuff to other equipment which is connected to intracorporeal organ. Air embolisms may result.



General advice

- Do not inflate the cuff without being wrapped over the arm.
- Do not use a damaged cuff.

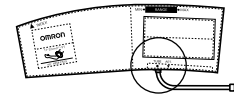
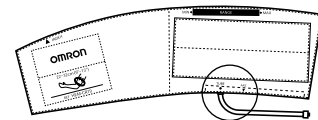
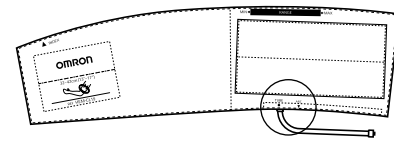
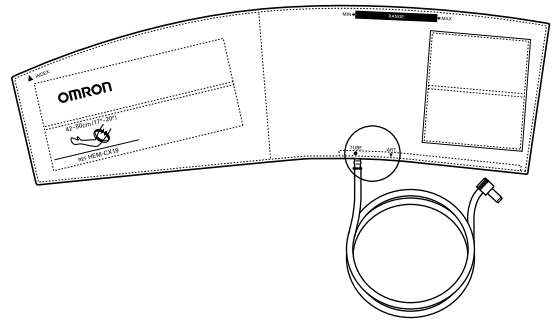

1. Select the cuff according to the arm size

Arm circumference	Name of the cuff
(7" - 9") 17-22 cm	HEM-907-CS19 (Small)
(9" - 13") 22-32 cm	HEM-907-CR19 (Medium)
(13" - 17") 32-42 cm	HEM-907-CL19 (Large)
(17" - 20") 42-50 cm	HEM-907-CX19 (Extra Large)

- Check the following before applying the cuff:

- 1) The bladder is correctly installed in the cuff.
- 2) The bladder is not twisted inside the cuff.
- 3) The bladder tube is protruding from the cuff as shown in the Figure on the right.

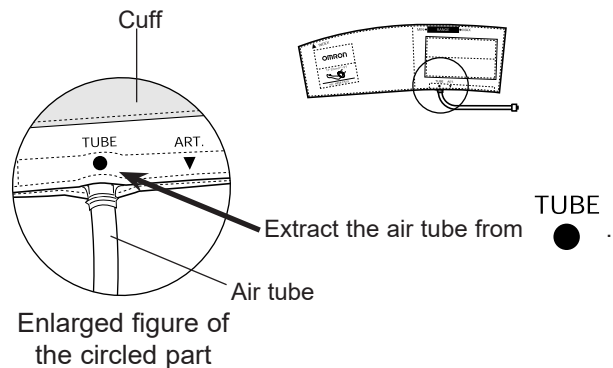

2. Connect the air tube securely.

To use the cuff in small, medium or large size

- Connect the air tube to the main unit by securing the air plug to the base of the air connector.
- Securely connect the air tube and the cuff/bladder set by rotating the luer connection as shown in the Figure on the right.

To use the cuff in extra-large size only

The extra-large cuff comes with an air tube with an integrated air plug. Connect the air plug of the cuff to the air connector securely when connecting to the main unit.

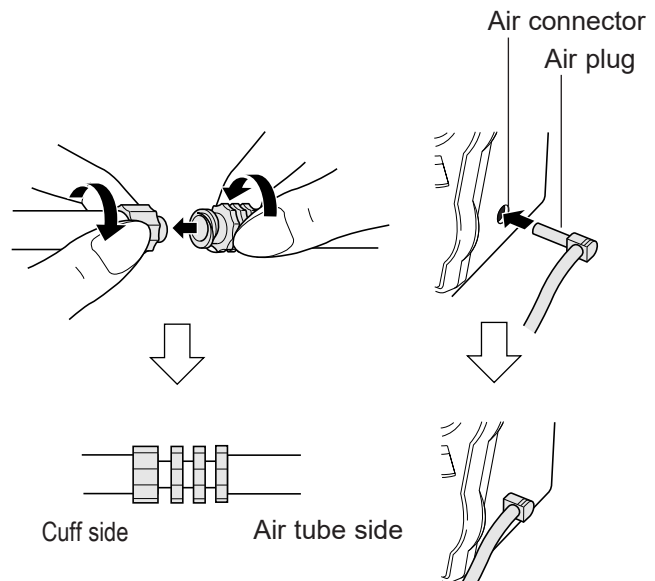

HOW TO APPLY THE CUFF

3. Place the right or left hand of the patient with the palm of hand facing upward.

4. Align the Artery Position Mark ^{ART.} ▼ with the brachial artery.

5. Wrap the cuff snugly using both hands and securely fasten it with the Velcro™ tape. At this time, the lower edge of the cuff must be placed 1/2" to 1" above the inner side of elbow joint.

- If the INDEX is positioned outside the RANGE, select the cuff suitable for the patient's arm circumference and wrap it again.
- Wrap the cuff so that you can insert only one finger between the cuff and arm.

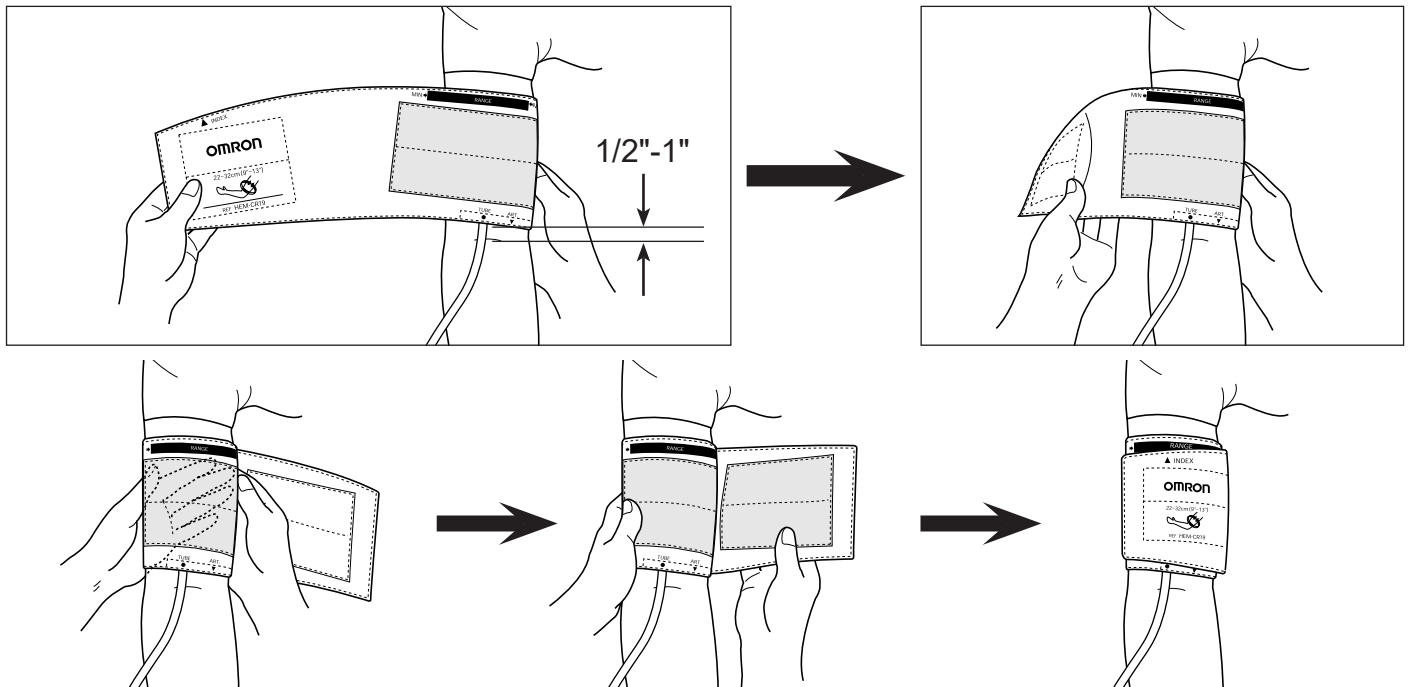
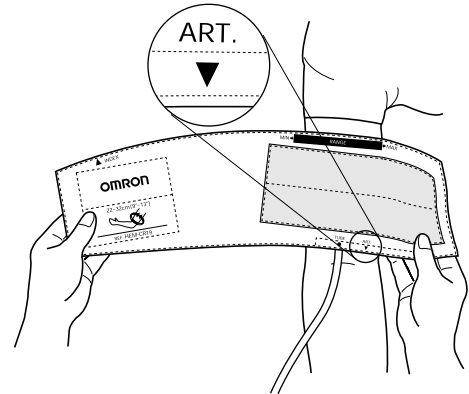

6. Keep the level of the cuff at the same level as the heart during the measurement.

HOW TO USE THE POWER SOURCE

**- DANGER -
TO REDUCE THE RISK OF
FIRE OR ELECTRIC SHOCK,
CAREFULLY FOLLOW THESE INSTRUCTIONS.**

- ⚠ For connection to a power supply not in the U.S.A., use an attachment plug adapter of the proper configuration for the power outlet.
- ⚠ The power unit (AC Adapter) is intended to be correctly oriented in a vertical or floor mount position.

NOTE: Use only the authorized AC Adapter that came with this monitor.



⚠ CAUTION



Use only authorized parts and accessories. Parts and accessories not approved for use with the device may damage the unit.

SAVE THESE INSTRUCTIONS

HOW TO USE THE POWER SOURCE

How to use the AC adapter

⚠Warning	
Do not use this unit in the presence of flammable gas, or anesthetics, or in a high pressure oxygen room or oxygen tent.	
Do not touch the AC adapter with wet hands.	

⚠Caution	
Be sure to use the AC adapter from the power supply of 110 VAC.	
Do not install or store this unit where it may come in contact with water or liquid medication. This is a Class II device with double isolation. Earth pin is not for protective purposes.	

General advice
<ul style="list-style-type: none">• Read the instruction manual of the other devices to be used at the same time with this unit to understand and be aware of the interaction between the devices.

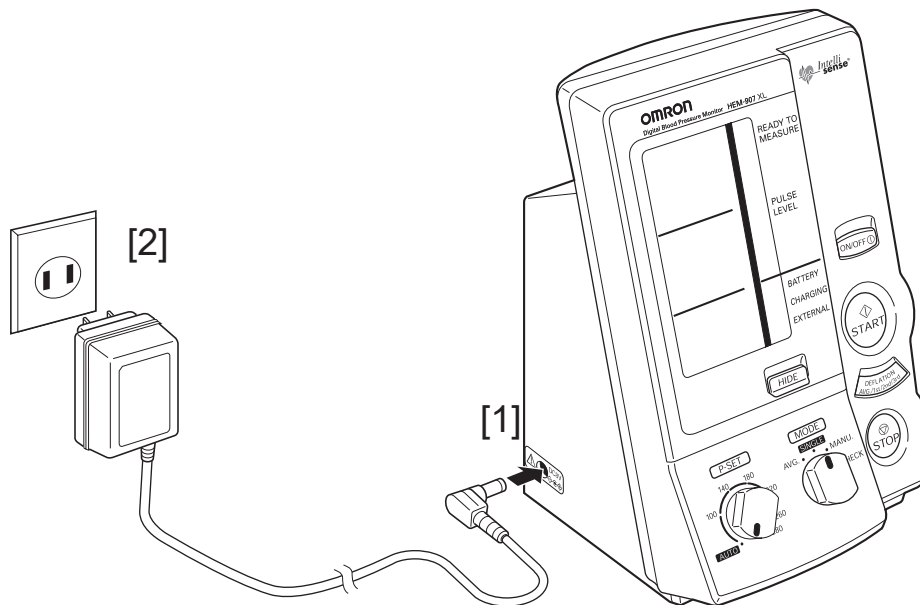

Connect the AC adapter to the DC jack of the main unit [1] and the electric outlet [2].

NOTE: When the AC adapter is connected and the unit is turned off, the AC adapter charges the installed rechargeable battery.



HOW TO USE THE POWER SOURCE

Installation and Replacement of Battery Pack

⚠Warning	
If battery fluid gets into your eye or comes in contact with skin, wash the affected area with water repeatedly. Immediately consult a doctor for treatment.	
Do not use the battery pack for devices other than for this unit.	
Do not disassemble the battery pack.	

1. Remove both screws on the upper portion of the battery cover of this unit, and remove the cover.
2. Disconnect the old battery pack from the connector and replace with a new one.
3. Install the battery cover and fasten it with both screws. Be careful not to pinch the lead wire.
4. Connect the main unit to the AC adapter to charge the new battery. The battery is not charged when you purchase the monitor. When you use the battery for the first time, charge it for more than twelve hours before use.

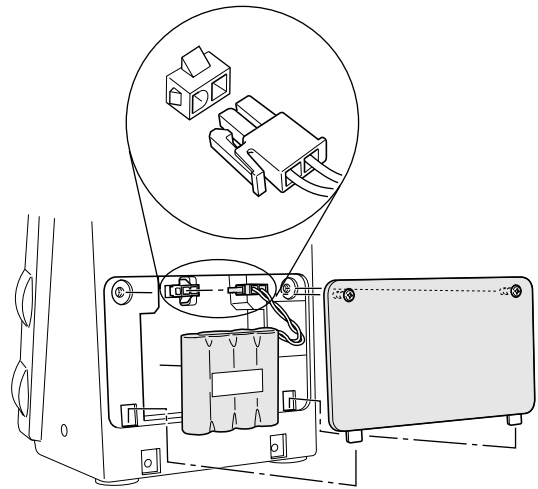



Battery life

- You can use the unit for approximately three hundred measurements with one charge.
- Approximate life of battery is two years. However the battery life from each charging may be shortened depending on the state of using. If the interval between charging becomes short and the  icon appears frequently, replace it.

Charging time

- At approximately five seconds after connecting the AC adapter, the unit will start battery charging automatically.
- While the battery is being charged, the  icon turns on.
- The battery can be completely charged in approximately twelve hours.

Battery low

- When the  icon starts to blink, twenty to thirty measurements remain on the battery. However if the Battery Low Mark starts to blink, charge it soon.
- If the  icon is displayed, the battery is low and the unit cannot operate. Please charge the battery.



Automatic Power Off

- When using the unit with the battery, the unit will turn off automatically after five minutes of inactivity.
- While the AC adapter is connected, the Auto Power Off function does not work.

HOW TO MEASURE BLOOD PRESSURE

⚠Warning	
If cuff inflation does not stop, remove the cuff or pull out the air tube from the main unit.	

General advice	
• Patients should not touch the unit.	

⚠Caution	
Confirm readings with the stethoscope when an irregular pulse wave is displayed or when the measured value is questionable or erratic.	
Do not use a cellular phone near this unit. Do not use this unit in a vehicle.	

List of Measurement Modes

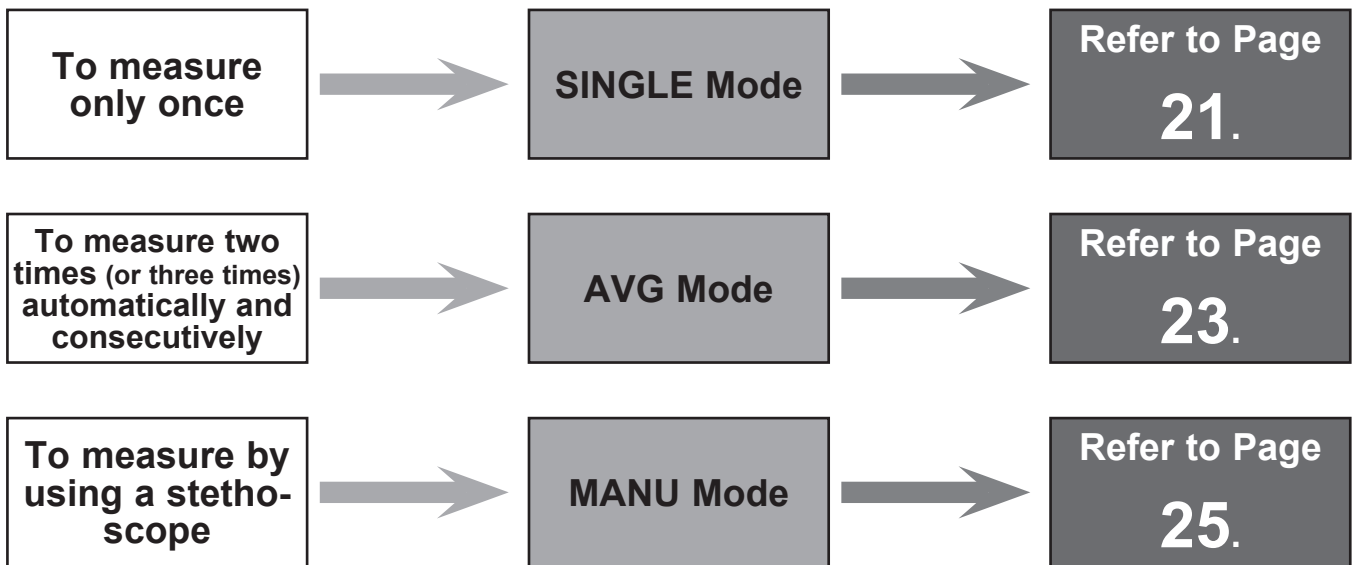

HOW TO MEASURE BLOOD PRESSURE (IN SINGLE MODE)

1. Push the ON/OFF (power) Button to turn on the power.

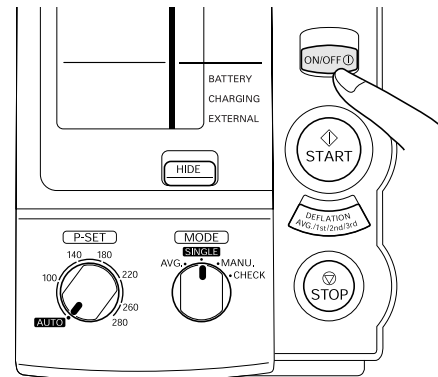

2. Set the MODE Selector to “SINGLE”.

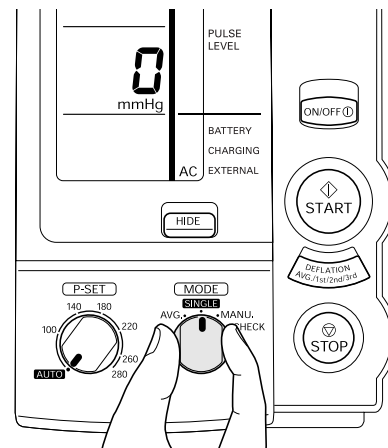

3. Set the P-SET (inflation level) Knob to “AUTO” or to the target pressure value.

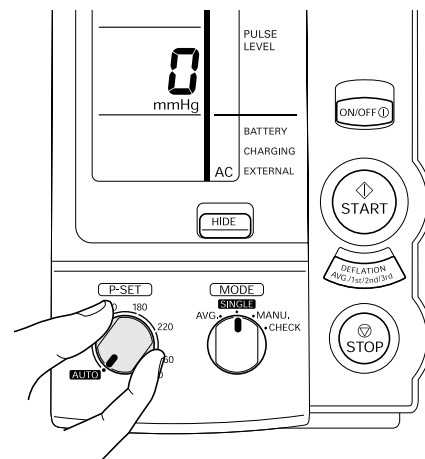

4. Measure the patient’s arm size, and wrap appropriate cuff over the patient’s arm. (Refer to Pages 15 and 16.)

HOW TO MEASURE BLOOD PRESSURE (IN SINGLE MODE)

5. Push the START Button to start the measurement.

- Do not push the START Button without wrapping the cuff.
- If you want to stop measurement, push the STOP Button. The cuff will rapidly deflate.

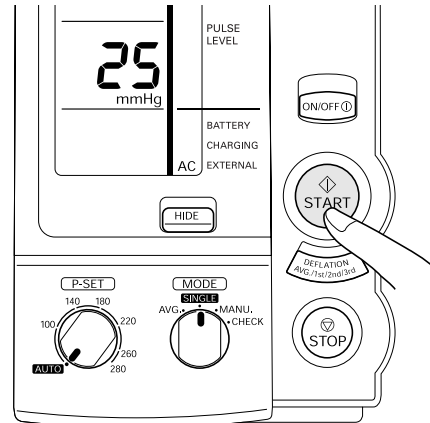
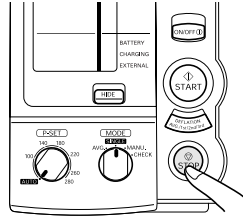

6. The measurement results are displayed.

- While the battery pack is in use, the monitor will turn off automatically after five minutes of inactivity and the display (measurement results) will disappear. (Automatic Power Off)

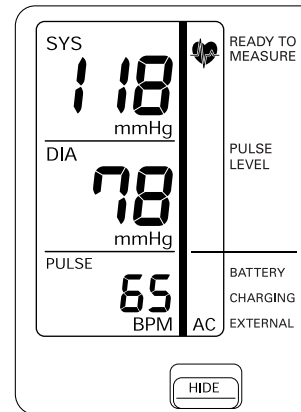

7. Push the ON/OFF (power) Button to turn off the power.

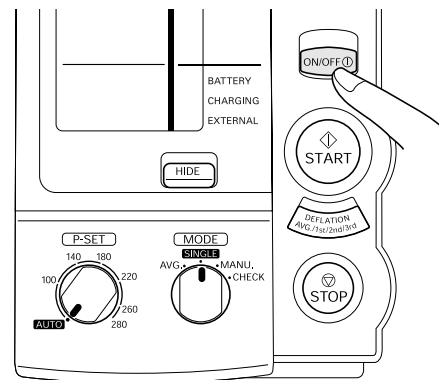

If the monitor determines that the pressure value is not correct, an error display appears (Er1 to 9). In this case, refer to Page 29 and start the measurement again.

HOW TO MEASURE BLOOD PRESSURE (IN AVERAGE MODE)

1. Push the ON/OFF (power) Button to turn on the power.

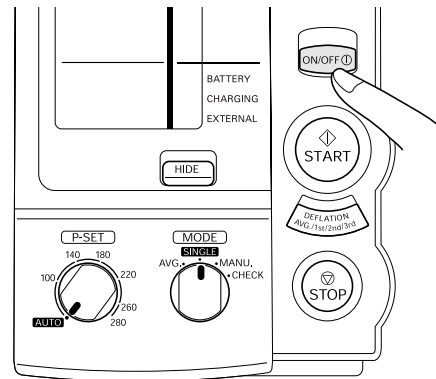

2. Set the MODE Selector to “AVG”.

The factory-set values are set as follows:

- Number of measurements: 2
- Waiting time until the 1st measurement: 0 sec.
- Interval: 1 min.

To change these factory-set values, refer to Page 14.

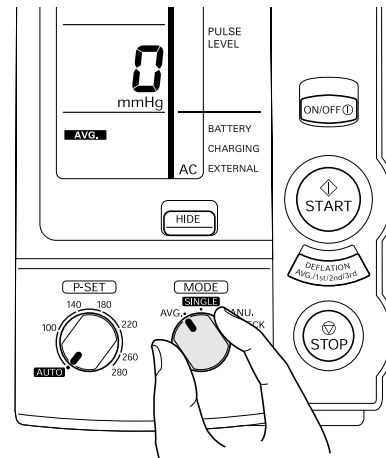

3. Set the P-SET (inflation level setting) Knob to “AUTO” or the target pressure value.

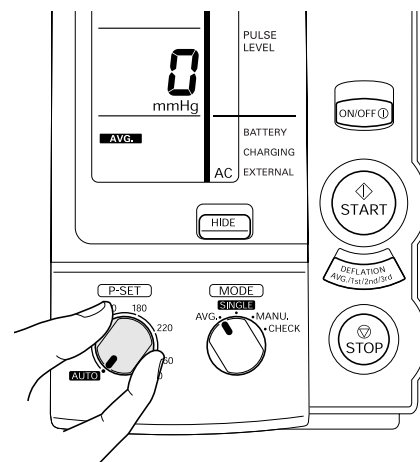

4. Measure the patient's arm size and wrap appropriate cuff over the patient's arm. (Refer to Pages 15 and 16.)

HOW TO MEASURE BLOOD PRESSURE (IN AVERAGE MODE)

5. Push the START Button to start the measurement.

After the pre-select waiting time, the unit takes the 1st measurement.

After displaying the results of 1st measurement, subsequent measures occur automatically at the specified intervals.

- For setting the number of measurements, the waiting time until the 1st measurement, and the interval, refer to Page 14.
- If you want to stop measurement, push the STOP Button. The unit will rapidly deflate.
- If an error occurs during measurement, the monitor will automatically start measurement again. If a second error occurs, measurement will automatically stop.
- Do not push the START Button without wrapping the cuff.

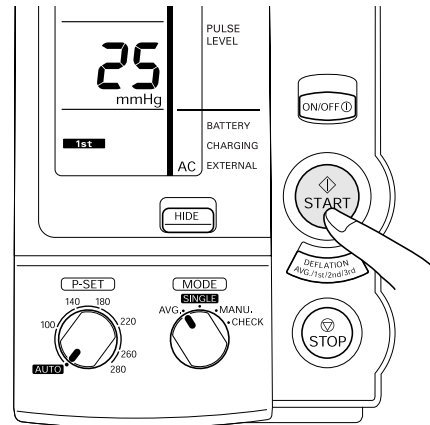

6. The measurement results are displayed.

After all the measurements are finished, average values will be displayed.

Each time the DEFLATION (deflation control) / Measurement Result Display Switch Button is pushed, the measurement results for each reading and the average value will be displayed.

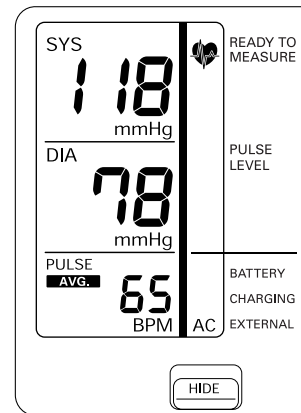

- While the battery is in use, the monitor will turn off after five minutes of inactivity and the display (measurement results) will disappear. (Automatic Power Off)

7. Push the ON/OFF (power) Button to turn off the power.

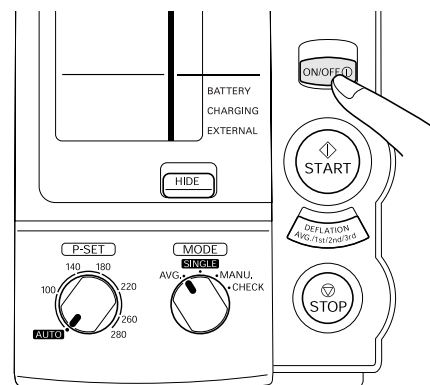

If the monitor determines that the pressure value is not correct, an error display appears (Er1 to 9). In this case, refer to Page 29 and start the measurement again.

HOW TO MEASURE BLOOD PRESSURE (IN MANUAL MODE)

1. Push the ON/OFF (power) Button to turn on the power.

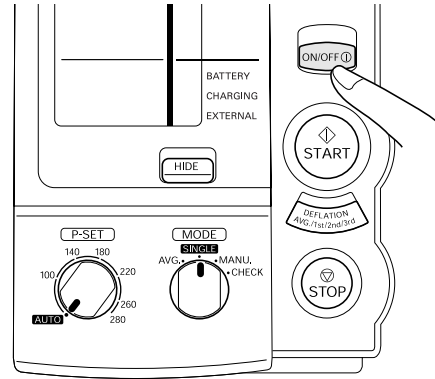

2. Set the MODE Selector to "MANU".

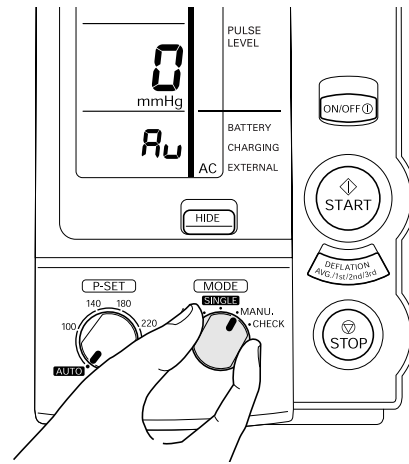

3. Set the P-SET (inflation level setting) Knob to "AUTO" or the target pressure value.

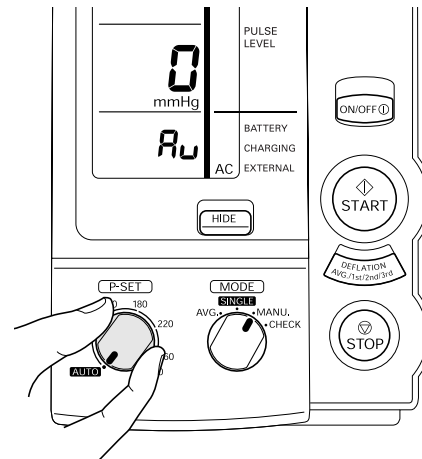

4. Measure the patient's arm size and wrap appropriate cuff over the patient's arm. (Refer to Pages 15 and 16.)

HOW TO MEASURE BLOOD PRESSURE (IN MANUAL MODE)

5. Place the stethoscope on the patient's arm.

6. Push the START Button to start the measurement.

- Do not push the START Button without wrapping the cuff.
- Do not squeeze or press the cuff during the measurement.
- If you want to inflate again after the start of deflation, push the START Button.
- If you want to accelerate deflation after the start of deflation, push the DEFLATION (deflation control) / Measurement Results Display Switch Button. Each time the Button is pushed, cuff is deflated rapidly in increments of 5 to 10 mmHg.

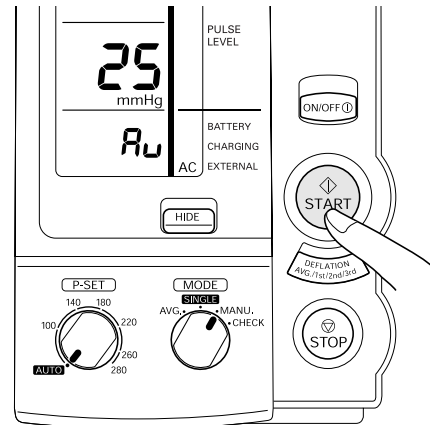

7. Take the readings.

8. Push the STOP Button to remove air inside the cuff.

- The unit does not automatically deflate in the MANU Mode.

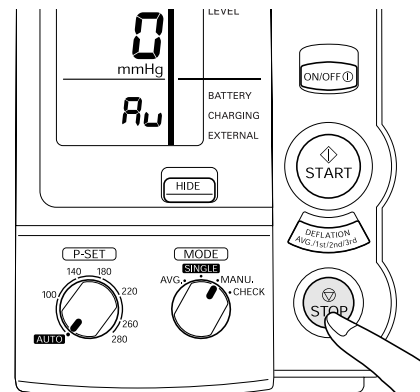

9. Push the ON/OFF (power) Button to turn off the power.

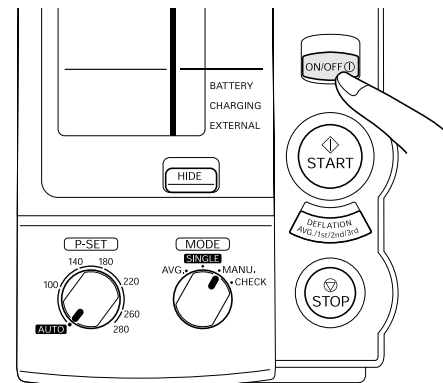

If the monitor determines that the pressure value is not correct, an error display appears (Er1 to 9). In this case, refer to Page 29 and start the measurement again.

HOW TO CHECK PRESSURE ACCURACY (IN CHECK MODE)

Accuracy of pressure display can be checked in the CHECK Mode.

What you need to prepare

(1) Calibrated mercury manometer (including inflation bulb), (2) T-tube, (3) two air tubes, and (4) a sturdy cylindrical shaped object on which the cuff is wrapped.

How to check

1. Connect the manometer, inflation bulb, cuff, and the monitor with the T-tube as shown in the figure on the right.
2. Tightly wrap the cuff over a sturdy cylinder.
3. Release the valve of inflation bulb to remove the air inside the cuff completely.
4. Push the ON/OFF (power) Button to turn on the monitor.
5. Set the MODE Selector to "CHECK".
6. Close the valve of inflation bulb and inflate the cuff to the pressure to be checked, based on the manometer read.
7. Compare the pressure values displayed on the monitor to the one on the manometer.

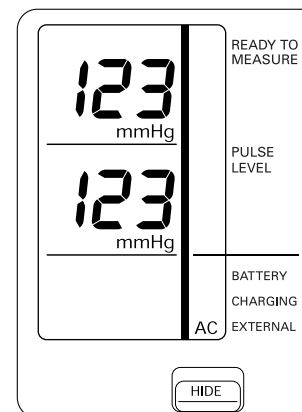
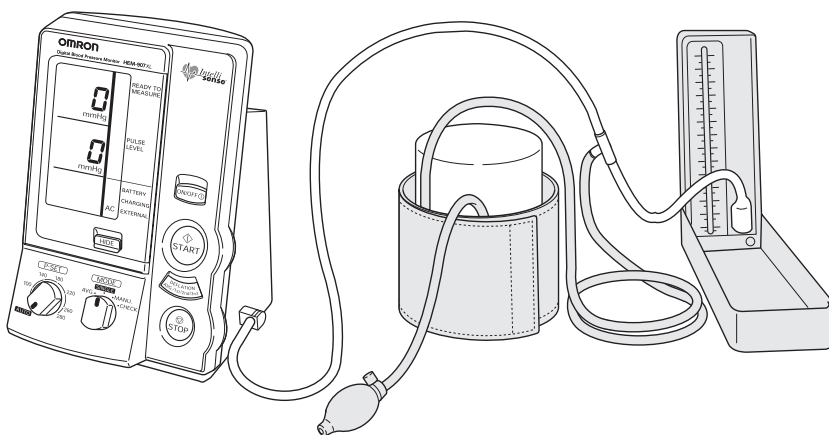

Check result

Accuracy of the monitor is validated to be ± 3 mmHg or 2% of standard manometer reading. If your result shows a difference exceeding the tolerance, contact Omron Healthcare's Customer Service at 1-877-216-1336.

HOW TO CLEAN THE UNIT AFTER USE

⚠ Caution

When cleaning this unit, unplug the AC adapter from the electric outlet.



After cleaning this unit, dry it well, before plugging the AC adapter in the electric outlet.



General advice

- Do not clean this unit with gasoline, paint thinner, or high concentration alcohol.
- Do not disinfect this unit by autoclave or gas sterilization (EtO, glutaraldehyde, or high concentration ozone.)

1. Wipe the monitor with a soft, damp cloth diluted with disinfectant alcohol, or diluted detergent.
2. Complete cleaning by wiping the monitor with a soft, dry cloth.

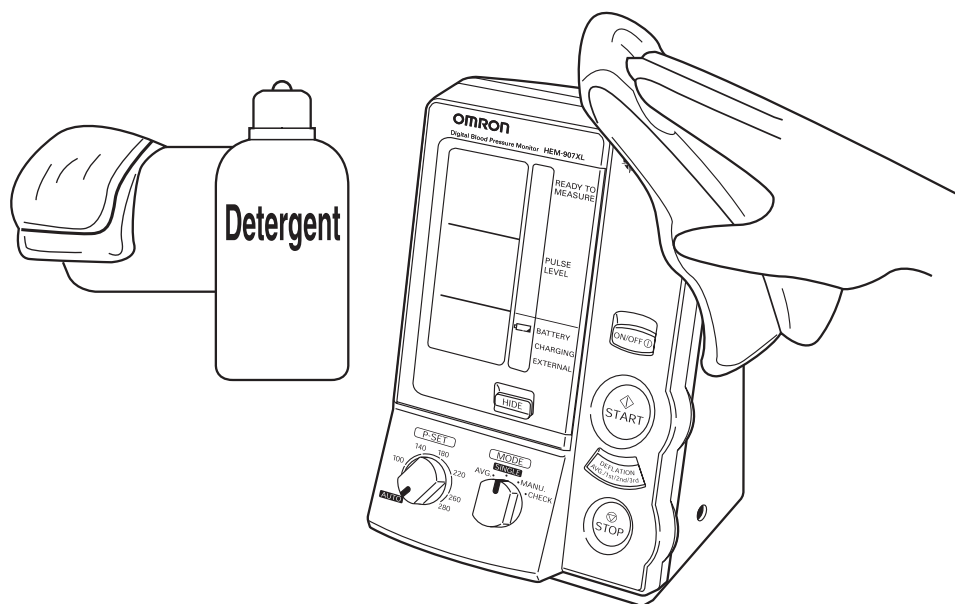

LIST OF ERROR CODES

Error code	Explanation	How to correct
E-r-1	Inflation error <ul style="list-style-type: none"> • When the pressure does not exceed 12 mmHg within the set time after the start of inflation • When the inflation does not reach the set cuff pressure within the specified time after the start of inflation 	<ul style="list-style-type: none"> • Confirm that the air tube connecting the cuff and the main unit is connected securely. • Confirm that the air flow in the air tube connecting the cuff and the main unit isn't being restricted.
E-r-2	Deflation error <ul style="list-style-type: none"> • When the deflation speed is too fast during the measurement • When the deflation speed is too slow during the measurement • When the measurement does not finish within the specified time after starting the measurement 	<ul style="list-style-type: none"> • Confirm that the cuff is wrapped correctly (refer to Pages 15 and 16). • Check bladder for leaks and, if necessary, replace the bladder with new one (option).
E-r-3	Overpressure error <ul style="list-style-type: none"> • The cuff pressure exceeded 299 mmHg. 	<ul style="list-style-type: none"> • Confirm that air flow in the air tube connecting the cuff and the main unit isn't being restricted.
E-r-4	Insufficient inflation error <ul style="list-style-type: none"> • Blood pressure could not be measured due to insufficient inflation level. 	<ul style="list-style-type: none"> • If the measurement is made by setting the P-SET to "AUTO", ask the patient not to move during the inflation. • Confirm that the P-SET is securely set to "AUTO". Turn the Knob counterclockwise as far as it goes until you can hear a click sound. • If the measurement is made by manual inflation level setting, set the value to 30 to 40 mmHg higher.
E-r-5	Indeterminable blood pressure error <ul style="list-style-type: none"> • Blood pressure could not be measured even when the cuff pressure reached the specified pressure. 	<ul style="list-style-type: none"> • Confirm that the cuff is wrapped correctly (refer to Pages 15 and 16).
E-r-6	Low pulse level error <ul style="list-style-type: none"> • Pulse wave was too small. 	<ul style="list-style-type: none"> • Confirm that the cuff is wrapped correctly (refer to Pages 15 and 16).
E-r-7	Blood pressure error <ul style="list-style-type: none"> • Relationship between systolic and diastolic pressures was abnormal. 	<ul style="list-style-type: none"> • Ask the patient not to move during the measurement.
E-r-8	Pulse rate error <ul style="list-style-type: none"> • Pulse rate did not stay within the range of 30 to 199 beats/min. 	<ul style="list-style-type: none"> • Check the patient for arrhythmia.
E-r-9	Device error <ul style="list-style-type: none"> • Main unit malfunction. 	<ul style="list-style-type: none"> • Contact Omron Healthcare's Customer Service toll-free at 1-877-216-1336.

TROUBLESHOOTING

If the unit malfunctions during use, please check the following:

Trouble	What to inspect	How to correct
<p>The unit inflates to abnormally high (low) pressure.</p>	<p>Is the cuff wrapped correctly?</p>	<p>Wrap the cuff correctly, and measure again. (Refer to Pages 15 and 16.)</p>
	<p>Is the patient moving during inflation?</p>	<p>Ask the patient not to move during measurement, and measure again.</p>
	<p>Does this patient have arrhythmia?</p>	<p>Set the P-SET to 30 to 40 mmHg higher than estimated systolic pressure of the patient, then measure.</p>
<p>The monitor cannot measure blood pressure.</p> <p>Measured values are abnormally high (low).</p>	<p>Check the patient's condition.</p>	<p>After checking the patient with the stethoscope refer to the "List of Error Codes". (Refer to Page 29.)</p>
	<p>Is the patient moving during the measurement?</p>	<p>Ask the patient not to move during measurement, and measure again.</p>
	<p>Does the patient have an arrhythmia?</p>	<p>Set the P-SET to 30 to 40 mmHg higher than estimated systolic pressure of the patient, then measure.</p>
	<p>Is the size of the cuff correct and is it wrapped correctly?</p>	<p>Select the cuff according to the patient's arm circumference, wrap it correctly, then measure again. (Refer to Pages 15 and 16.)</p>
	<p>Is the level of the brachium to which the cuff is wrapped at the same level as the heart?</p>	<p>Keep the level of the brachium to which the cuff is wrapped at the same level as the heart, then measure again.</p>
	<p>Are the patient's clothes restricting normal blood flow to the arm?</p>	<p>Remove the clothing and measure again.</p>

CAUTION

CAUTION:

Changes or modifications not expressly approved by Omron Healthcare, Inc. could void the user's authority to operate this product.

NOTE:

POTENTIAL FOR RADIO/TELEVISION INTERFERENCE (for U.S.A. only)

This product has been tested and found to comply with the limits for a Class B digital device, pursuant to part 15 of the FCC rules.

These limits are designed to provide reasonable protection against harmful interference in a residential installation. The product generates, uses, and can radiate radio frequency energy and, if not installed and used in accordance with the instructions, may cause harmful interference to radio communications. However, there is no guarantee that interference will not occur in a particular installation. If the product does cause harmful interference to radio or television reception, which can be determined by turning the product on and off, the user is encouraged to try to correct the interference by one or more of the following measures:

- Reorient or relocate the receiving antenna.
- Increase the separation between the product and receiver.
- Connect the product into an outlet on a circuit different from that to which the receiver is connected.
- Consult the dealer or an experienced radio/TV technician for help.

POTENTIAL FOR RADIO/TELEVISION INTERFERENCE (for Canada only)

This digital apparatus does not exceed the Class B limits for radio noise emissions from digital apparatus as set out in the interference-causing equipment standard entitled "Digital Apparatus", ICES-003 of the Canadian Department of Communications.

Cet appareil numérique respecte les limites de bruits radioélectriques applicables aux appareils numériques de Classe B prescrites dans la norme sur le matériel brouilleur: "Appareils Numériques", NMB-003 édictée par le ministre des communications.

FIVE YEAR LIMITED WARRANTY

Your HEM-907XL IntelliSense® Automatic Blood Pressure Monitor is warranted to be free from manufacturing defects for a period of five years under normal use. The five year warranty excludes the monitor cuff. The cuff is warranted for a one year period.

This warranty extends only to the original retail purchaser.

To obtain warranty service contact Omron Healthcare's Customer Service by calling 1-877-216-1336 for the address of the repair location and the return shipping and handling fee. Information for warranty service is available on our website at www.omronhealthcare.com

We will either repair or replace (at our option) free of charge any parts necessary to correct defects in the materials or workmanship. The above warranty is complete and exclusive. The warrantor expressly disclaims liability for incidental, special, or consequential damages of any nature. (Some states do not allow the exclusion or limitation of incidental or consequential damages, so the above warranty may not apply to you.)

Any implied warranties arising by the operation of law shall be limited in duration to the term of this warranty. (Some states do not allow limitations on how long an implied warranty lasts, so the above limitation may not apply to you.)

This warranty gives you specific legal rights, and you may have other rights which vary from state to state.

FOR CUSTOMER SERVICE CALL TOLL FREE: 1-877-216-1336

SPECIFICATIONS

Name:	OMRON Digital Automatic Blood Pressure Monitor	
Model:	HEM-907XL (HEM-907-Z2)	
Display:	Digital display	
Measurement:	Oscillometric method	
Measurement Range:	Pressure; 0 to 299 mmHg Pulse rate; 30 to 199 beats/min	
Accuracy:	Pressure; Within ± 3 mmHg or 2% of reading Pulse rate; Within $\pm 5\%$ of reading	
Inflation:	Automatic inflation with pumping	
Deflation:	Automatic deflation by electromagnetic control valve	
Air Release:	Automatic rapid air release by electromagnetic control valve	
Power supply:	AC adapter (AC 120V, 50/60Hz, 0.2A) Battery pack (DC 4.8V, 6W)	
Protection Class:	Class II Internally powered equipment	
Degree of Protection:	Type BF	
Operating Temperature / Humidity:	50°F to 104°F (10 to 40°C) / 30 to 85% RH (IPX 0 Rating)	
Storage Temperature / Humidity / Air pressure:	-4°F to 140°F (-20 to 60°C) / 10 to 95% RH / 700 - 1060 hPa	
Weight of Main Unit:	Approx. 32 oz (910 g)	
External Dimensions:	Approx. 5 1/2" (W) x 8"(H) x 5 1/6"(D) 139 (W) x 203 (H) x 131 (D) mm	
Accessories:	Cuff / bladder set Extra Large, Cuff / bladder set Large, Cuff / bladder set Medium, Cuff / bladder set Small, AC adapter, Battery pack, air tube 1.3 m (51 3/16"), Instruction Manual	
Options:	Air tube 1.3 m (51 3/16"), Stand exclusive for this unit (Item: HEM-907-STAND), Wall-hanging kit (Item: HEM-907-WKIT), Pole-mounting kit (Item: HEM-907-PKIT)	
Complies with:	IEC 60601-1:1988+A1:1991+A2:1995 IEC 60601-1-2:2007 ANSI/AAMI SP10:1992	General requirements for safety Electromagnetic compatibility - Requirements and tests Manual, Electronic or Automated Sphygmomanometers

Please note that specifications may be changed without prior notice.



Medical Equipment with respect to electric shock, fire and mechanical hazards only in accordance with UL 60601-1 and CAN/CSA C22.2 No. 601.1

FCC/ISED STATEMENT

FCC CAUTION

Changes or modifications not expressly approved by the party responsible for compliance could void the user's authority to operate the equipment.

This device complies with part 15 of FCC Rules and Innovation, Science and Economic Development Canada's licence-exempt RSS(s). Operation is subject to the following two conditions: (1) this device may not cause harmful interference, and (2) this device must accept any interference received, including interference that may cause undesired operation.

Note:

This equipment has been tested and found to comply with the limits for a Class B digital device, pursuant to part 15 of the FCC Rules. These limits are designed to provide reasonable protection against harmful interference in a residential installation. This equipment generates, uses and can radiate radio frequency energy and, if not installed and used in accordance with the instructions, may cause harmful interference to radio communications. However, there is no guarantee that interference will not occur in a particular installation. If this equipment does cause harmful interference to radio or television reception, which can be determined by turning the equipment off and on, the user is encouraged to try to correct the interference by one or more of the following measures:

- Reorient or relocate the receiving antenna.
- Increase the separation between the equipment and receiver.
- Connect the equipment into an outlet on a circuit different from that to which the receiver is connected.
- Consult the dealer or an experienced radio/TV technician for help.

