Alenti
Instructions for Use

ARJOHUNTLEIGH
GETINGE GROUP



WARNING

To avoid injury, always read this Instructions for Use and accompanied documents before using the product.



Mandatory to read the Instructions for Use

Design Policy and Copyright

® and ™ are trademarks belonging to the ArjoHuntleigh group of companies.

© ArjoHuntleigh AB 2017.

As our policy is one of continuous improvement, we reserve the right to modify designs without prior notice. The content of this publication may not be copied either whole or in part without the consent of ArjoHuntleigh AB.

Contents

Foreword	4
Intended Use	5
Safety Instructions	6
Preparations	7
Part Designations	8
Product Description/Function	10
Control Panel	10
Hand Control	10
Positioning Handle, Transfer Handles, Hand Rest and Handle Arms	11
Central Brakes	11
Backrest	11
Emergency Stop	12
Automatic Safety Stop	12
Emergency High/Low	12
Battery Charger	12
Accessory Description	13
Scale (optional)	13
Bedpan and Bedpan Holder (optional)	13
Leg Support (optional)	14
Safety Belt	15
Transfer the Patient	18
From a Standing Position	18
To a Standing Position	19
From a Standing and Raising Aid	20
To a Standing and Raising Aid	21
From Wheelchair	22
To Wheelchair	23
To the Toilet	24
From Bed - Sitting	24
To Bed - Sitting	26
From Bed - Laying Down	26
To Bed - Laying Down	28
Bathe the Patient	30
To Bath	30
From Bath	32
Cleaning and Disinfection Instructions	34
Battery Instructions	37
Care and Preventative Maintenance	38
Troubleshooting	42
Alarms	43
Technical Specifications	44
Dimensions	46
List of Standards and Certificates	47
Labels on the Alenti Lift	48
Electromagnetic Compatibility	50
Parts and Accessories	52

Foreword

Thank you for purchasing ArjoHuntleigh equipment.

Your Alenti® lift and hygiene chair is part of a series of quality products designed especially for hospitals, nursing homes and other health care use.

We are dedicated to serving your needs and providing the best products available along with training that will bring your staff maximum benefit from every ArjoHuntleigh product.

Please contact us if you have any questions about the operation or maintenance of your ArjoHuntleigh equipment.

Please read this *Instructions for Use* thoroughly!

Please read this *Instructions for Use (IFU)* in its entirety before using your Alenti lift and hygiene chair.

Information in the *IFU* is crucial to the proper operation and maintenance of the equipment and will help protect your product and make sure that equipment performs to your satisfaction. Some of the information in this *IFU* is important for your safety and must be read and understood to help prevent possible injury.

Unauthorized modifications on any ArjoHuntleigh equipment may affect its safety. ArjoHuntleigh will not be held responsible for any accidents, incidents or lack of performance that occur as a result of any unauthorized modification to its products.

Report Unexpected Operations or Events

Contact your local ArjoHuntleigh representative if any unexpected operations or events occur. The contact information appear on the last page of this *IFU*.

Service and Support

A service routine must be performed on your Alenti lift every year by ArjoHuntleigh qualified personnel to make sure the safety and daily operation of your product. See section *Care and Preventative Maintenance* on page 38.

If you require further information, please contact your local ArjoHuntleigh representative who can offer comprehensive support and service programs to maximize the long term safety, reliability and value of the product.

Contact your local ArjoHuntleigh representative for replacement parts. Your service representative stocks the parts you will need. The telephone number appears on the last page of this *Instructions for Use (IFU)*.

Complementary Information

A set of Quick Guides/Posters and a DVD accompanies this *IFU*.

Please note that the Quick Guides/Posters and the DVD do not replace the information in this *IFU*. The *IFU* contains additional important safety instructions.

Definitions in this *IFU*:

WARNING

Means:

Safety warning. Failure to understand and obey this warning may result in injury to you or to others.

CAUTION

Means:

Failure to follow these instructions may cause damage to all or parts of the system.

NOTE

Means:

This is important information for the correct use of this system or equipment.



Means:

The name and address of the manufacturer.

Intended Use

This equipment must be used in accordance with these safety instructions. Anyone using the equipment must also have read and understood the instructions in this *Instructions for Use (IFU)*.

If there is anything you are not sure about, contact your ArjoHuntleigh representative.

This equipment is intended for lifting and transporting residents to and from a bathroom in a care facility and to assist with the bathing process. *Alenti* must be used by appropriately trained caregivers with adequate knowledge of the care environment, its common practices and procedures, and in accordance with the guidelines in the *Instructions for Use (IFU)*

Resident Assessment

We recommend that facilities establish regular assessment routines. Caregivers should assess each resident according to the following criteria prior to use:

- The resident's weight should not exceed the Safe Working Load of 182 kg / 400 lbs.
- The resident should be active or semi-active (i.e. able to sit upright self-supporting on the side of a bed or toilet).
- The resident should understand and respond to instructions to stay seated in an upright position.

If a resident does not meet these criteria an alternative lift and hygiene chair shall be used.

Lifetime of Equipment

The equipment must only be used for the purposes stated above.

The lifetime of this equipment is ten (10) years and the service life of the safety belt is two (2) years. Depending on the storage of the battery, the use frequency and the charging intervals, the service life of the battery is 2-5 years.

The lifetime and service life are as stated providing that the preventative maintenance are being carried out in accordance with the instructions for care and maintenance in this *IFU*.

Depending on level of wear some equipment parts such as castors and hand control may need to be replaced during the equipment's lifetime according to information in the *IFU*.

Safety Instructions

WARNING

To avoid the device in use from tipping, do not raise or lower other equipment close to it and be aware of stationary object when lowering.

WARNING

To avoid the device from tipping and the patient from falling, do not use the equipment on floor with recessed drains, holes or slopes exceeding a ratio of 1:50 (1.15°).

WARNING

To avoid the patient from falling, always make sure that the device is in the lowest possible position before attempting to transfer, dress or undress the patient.

WARNING

To avoid explosion or fire, never use the equipment in oxygen rich environment, in presence of heat source or flammable anaesthetic gases.

WARNING

To avoid entrapment, make sure to keep the patients hair, arms and feet close to the body and use designated grab supports during any movement.

WARNING

To avoid injury, make sure that the patient is not left unattended at any time.

Preparations

Actions Before First Use

(9 steps)

- 1 Make sure to check the *Alenti* lift for transport damages.
- 2 Check that all parts of the product are supplied. Compare with the *Parts Designation* list in this *IFU*. If any part is missing or damaged - DO NOT use the product.
- 3 Read the *IFU*.
- 4 Unpack the battery charger and install it according to the *Battery Charger IFU*.
- 5 Perform a functionality test according to section *Care and Preventative Maintenance* on page 38.
- 6 Disinfect the product according to section *Cleaning and Disinfection Instructions* on page 34.
- 7 Find a dry area with good ventilation for storing the *Alenti* lift.
- 8 Choose a designated area where the *IFU* should be kept and is easily accessible at all times.
- 9 Make sure to have set up routines for assistance and rescue in case of a patient emergency.

NOTE

If you have any questions, please contact your local ArjoHuntleigh representative for support and service. The contact numbers appear on the last page of this *IFU*.

Actions Before Every Use

(4 steps)

- 1 Check that all parts are in place. Compare with the *Parts Designation* list in this *IFU*.
- 2 If any part is missing or damaged - do NOT use the product.

3 **WARNING**

To prevent cross-contamination, always follow the disinfection instructions in this *IFU*.

- 4 Make sure the battery is charged.

The Alenti Lift Directions

The driving direction during transfer is according to the illustration below.

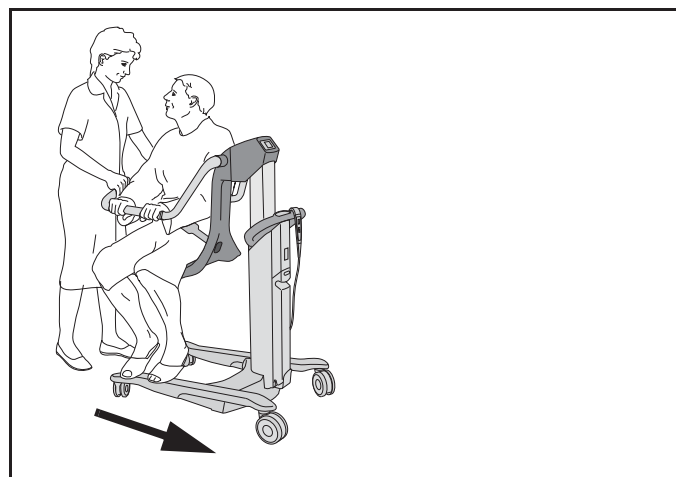

The directions *right*, *left*, *front* and *back* in this *IFU* are given below.

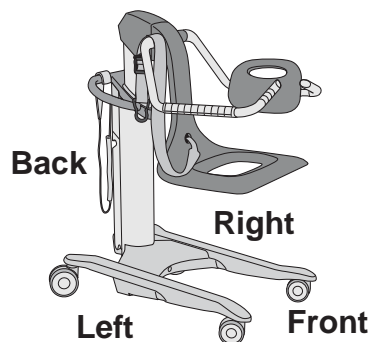

Part Designations

- 1 Positioning handle
- 2 Hand control
- 3 Lift pillar
- 4 Hand rest - handle arm
- 5 Backrest - handle arm
- 6 Hand rest
- 7 Backrest
- 8 Transfer handles
- 9 Safety belt
- 10 Seat 
- 11 Central Brakes
- 12 Scale (optional)
- 13 Control panel
- 14 Emergency High/Low
- 15 Battery release button (Emergency stop)
- 16 Battery
- 17 Bedpan (optional)
- 18 Bedpan holder handle (optional)
- 19 Bedpan holder (optional)
- 20 Leg support bar with straps (optional)



Applied part: Type B. (seat including all attached parts to it)

Protection against electric shock in accordance with IEC 60601-1.

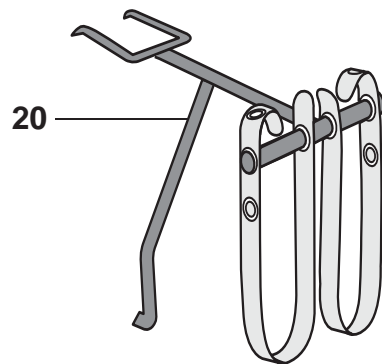
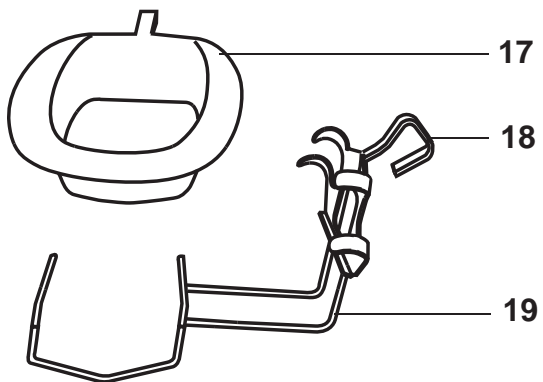
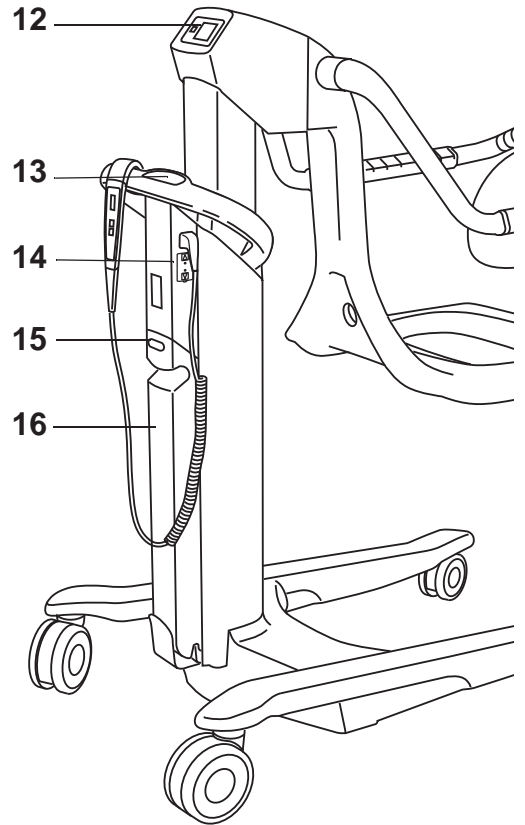
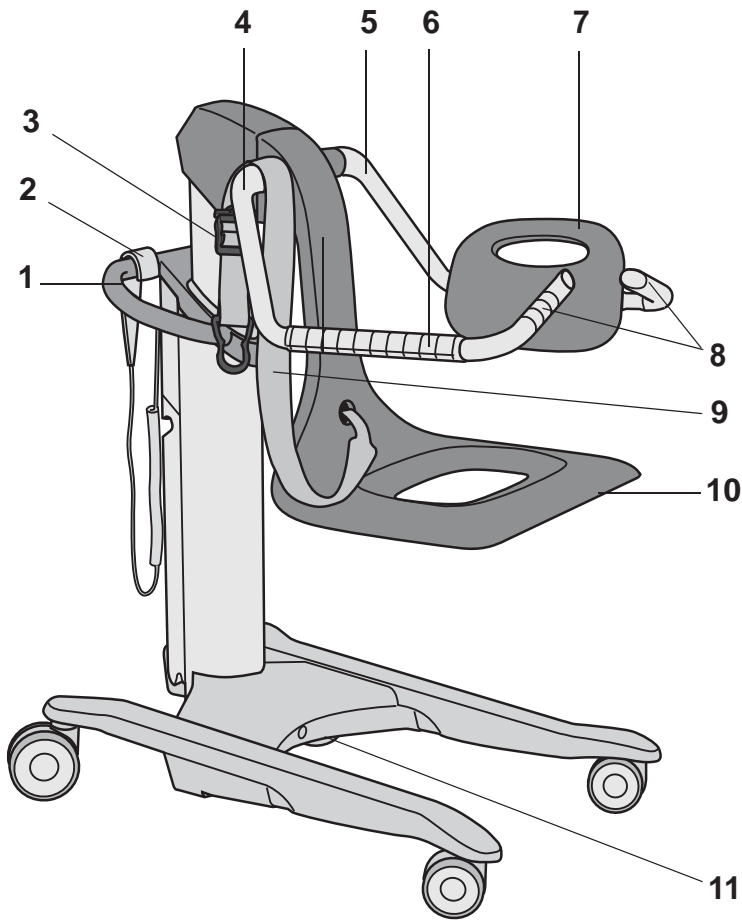

Product Description/Function

Fig. 1

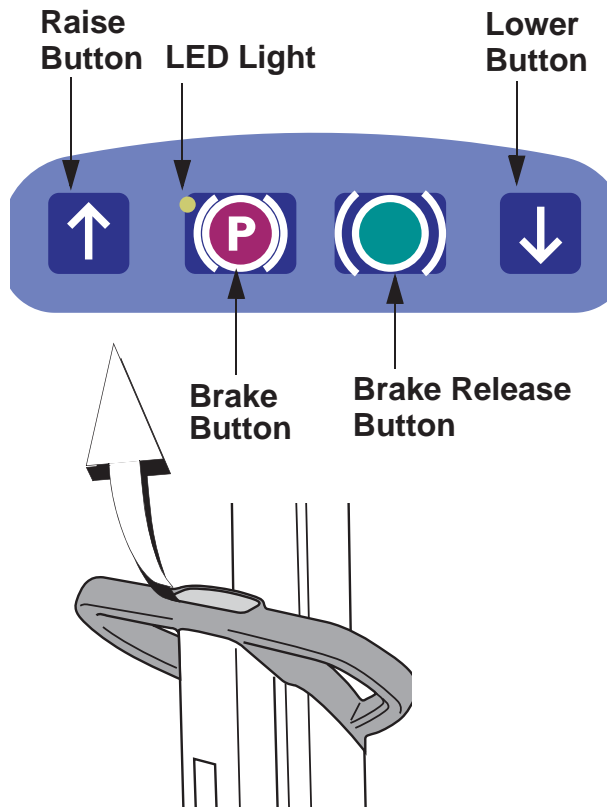

Control Panel

The control panel has four control buttons. (See Fig. 1)

- Press the Raise button (up arrow) to raise the *Alenti* lift.
- Press the Lower button (down arrow) to lower the *Alenti* lift.
- Press the Brake button (dark red button with a P) to activate the brakes.
A flashing LED light indicates when the brakes are active. The LED light will later turn itself off.
- Press the Brake Release button (green brake symbol) to release the brakes.

Hand Control

The hand control has an integrated hook which makes it easy to attach to various parts of the *Alenti* lift. (See Fig. 2)

- Unhook the hand control and hold it in your hand.
- Press the Raise button (up arrow) on the hand control in order to raise the *Alenti* lift.
- Press the Lower button (down arrow) on the hand control in order to lower the *Alenti* lift.
- Press the Brake button (dark red button with a P) to activate the brakes.
A flashing LED light indicates when the brakes are active. The LED light will later turn itself off.
- Press the Brake Release button (green brake symbol) to release the brakes.

Fig. 2

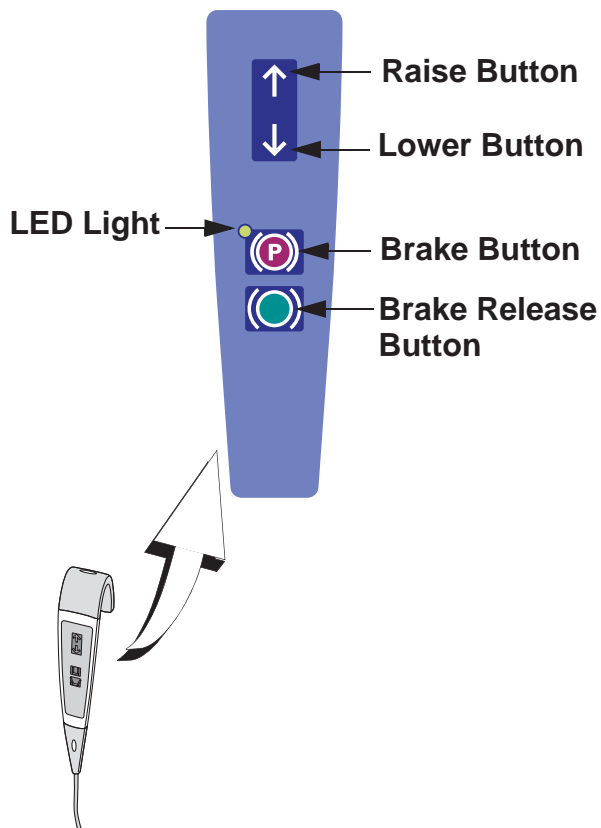
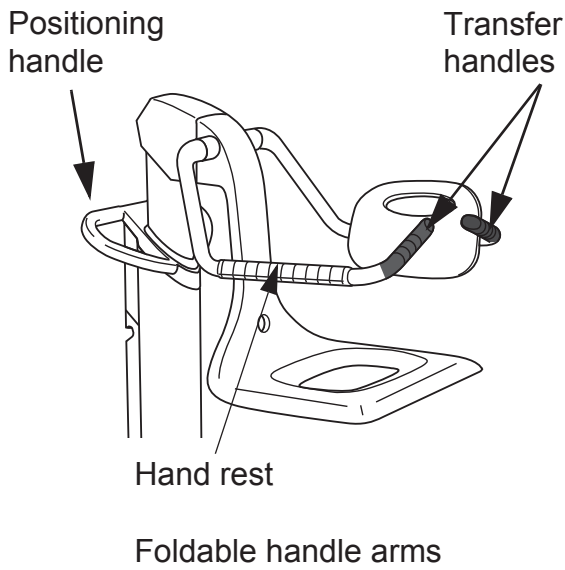

Fig. 1



Positioning Handle, Transfer Handles, Hand Rest and Handle Arms

(See Fig. 1)

- Use the positioning handle for positioning the *Alenti* lift near a bath or bed.
- Use the transfer handles during transfer.
- The hand rest is for the patient to hold on to with his or her hands. The hand rest is also used as an attachment for the backrest.
- The handle arms can be folded backwards during stationary transfers and during bath.

Central Brakes

The brakes are two cylinders, placed under the chassis, operated from the control panel or the hand control.

The brake action is achieved when the cylinders descend and make contact with the floor.

Backrest

- The backrest can be attached on both hand rests.
- Attach the backrest by pressing it down on the hand rest (**A**). (See Fig. 2)
- Remove the backrest by pulling it upwards (**B**). (See Fig. 2)

Before placing the patient in the *Alenti* lift:

- Choose from which side of the bathtub the *Alenti* lift will be positioned.
- If the *Alenti* lift will be positioned on the left side of the bathtub, place the backrest on the left hand rest.

If the *Alenti* lift will be positioned on the right side of the bathtub, place the backrest on the right hand rest.

Fig. 2

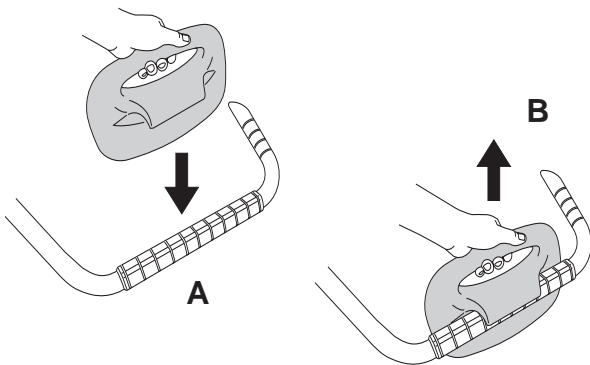
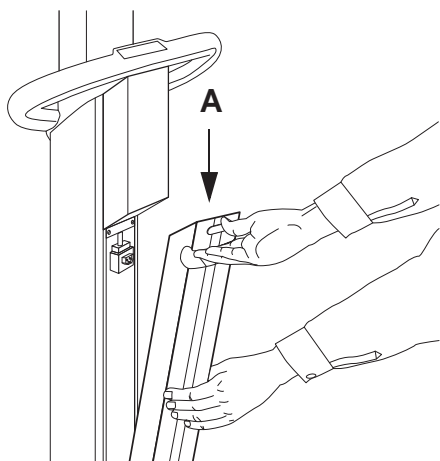

Fig. 1



Emergency Stop

If, for any reason the *Alenti* lift does not respond to the control buttons, you can stop lift movement by pressing the battery release button (A) and pull it out. (See Fig. 1)

Contact your local ArjoHuntleigh representative before using the *Alenti* lift again.

Automatic Safety Stop

To prevent getting pinches between the *Alenti* lift and an object, the *Alenti* lift is equipped with an automatic safety stop feature. The *Alenti* lift automatically stops when lowered on a fixed object.

Fig. 2

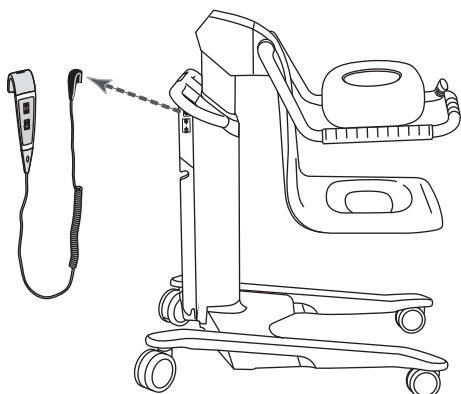

Emergency High/Low (2 steps)

If, for any reason, the *Alenti* lift does not respond to the control buttons, it is possible to raise or lower the *Alenti* lift by using the Emergency High/Low.

- 1 Unplug the hand control. (See Fig. 2)
- 2 Press a blunt, thin object (i.e. a pen) into one of the holes in the panel. (See Fig. 3)
 - Press it into the hole under the “up arrow” in order to raise the *Alenti* lift.
 - Press it into the hole above the “down arrow” in order to lower the *Alenti* lift.

Contact your local ArjoHuntleigh representative before using the *Alenti* lift again.

Fig. 3

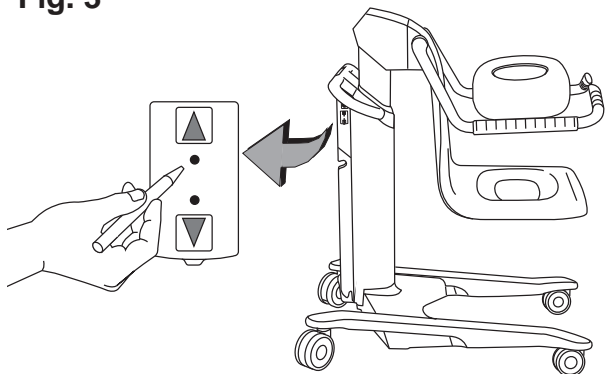

CAUTION

Do not use an object with a sharp tip when pressing into the holes, it can damage the emergency High/Low.

NOTE

The emergency High/Low overrides important safety functions such as the automatic safety stop.

The emergency High/Low shall only be used when both the control panel and hand control are out of order.

NOTE

A continuous beeping sound is heard during the emergency “up” and “down” movement.

Fig. 4

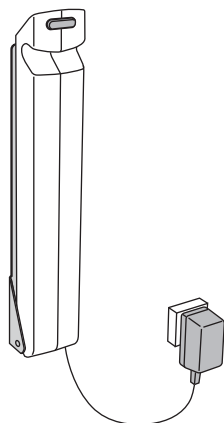

Battery Charger

Attach the battery charger to a suitable wall and connect it to a wall socket. (See Fig. 4)

For charge installation, see the *Battery Charger IFU*.

Accessory Description

Fig. 1

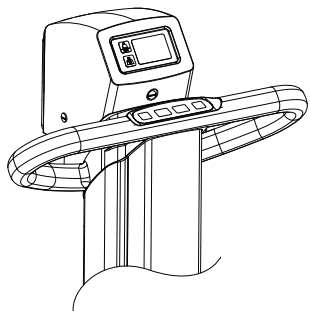

Scale (optional)

The scale is located on the *Alenti* lift pillar. (See Fig. 1)

To use the scale, if available, refer to the *Scale IFU*.

Bedpan and Bedpan Holder (optional) (3 steps)

Fig. 2

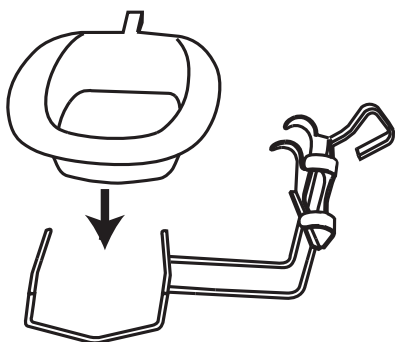

WARNING

To avoid entrapment or pinching of genitals, make sure there is enough clearance during movement over the bathtub edge, toilet, bedpan or other furniture.

- 1 Fit the bedpan into the holder.
(See Fig. 2)
- 2 The bedpan holder fits onto the back of the seat of the *Alenti* lift. (See Fig. 3)
- 3 Fold up the bedpan holder handle in to a locked position.
(See Fig. 4)

Fig. 3

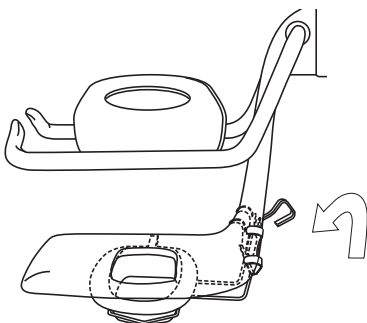

Fig. 4

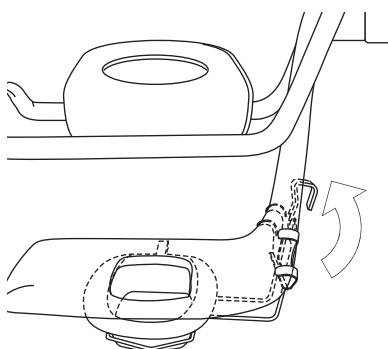

Fig. 1

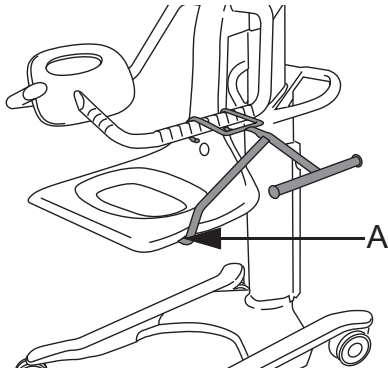

Fig. 2

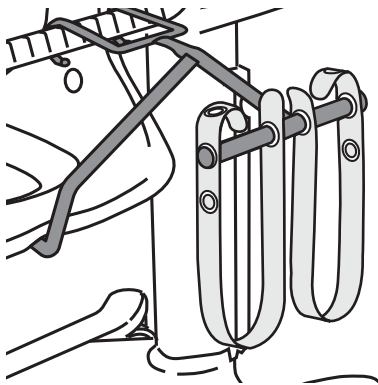
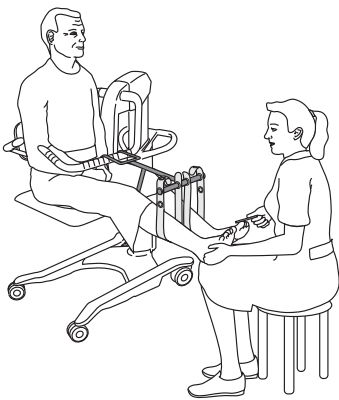

Fig. 3



Leg Support (optional)

The leg support assists caregivers when providing foot care to a patient seated in the *Alenti* lift.

- Attach the leg support to the hand rest and the bar between the patient's legs, against the flat rim under the seat (**A**). (**See Fig. 1**)
- Thread the straps plastic fasteners onto the bar according to the illustration. (**See Fig. 2**)
- All foot care provided to a patient sitting at the *Alenti* lift, must be performed with the *Alenti* lift in a lowered position.
- To avoid back strain, we recommend that the caregiver sits down while performing the foot care. (**See Fig. 3**)
- The height of the legs can be adjusted by using a series of holes in the straps attached to the leg support bar.

When adjusting the straps make sure that:

- the patient's legs are in an ergonomic height for the sitting caregiver and
- the patient is comfortable.

Safety Belt

Safety Belt

(14 steps)

Use the safety belt at all times.

Exceptions can be made while patient is securely positioned in the bathtub and during stationary transfers to and from the *Alenti* lift.

The safety belt helps the patient stay positioned properly on the seat.

Always inspect the safety belt before use, to make sure it is in good condition, without any loose threads, tears or other defects.

Always attach the safety belt before the patient is seated in the *Alenti* lift.

1 Attach the backrest by pressing it down on the hand rest (A). (See Fig. 1)

2 Turn the safety belt stop plate (B) so it gets entirely in contact with the safety belt. (See Fig. 2)

3 Insert the safety belt end through the hole in the seat. (See Fig. 3)

4 The safety belt stop plate (B) will self lock at the back of the seat, preventing the safety belt from coming loose from the seat. (See Fig. 4)

Fig. 1

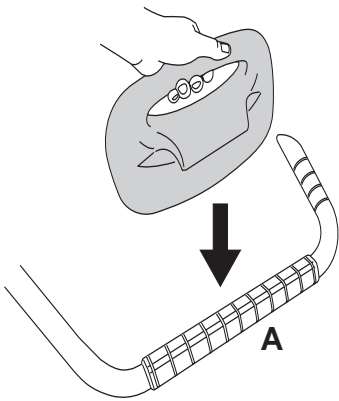

Fig. 2

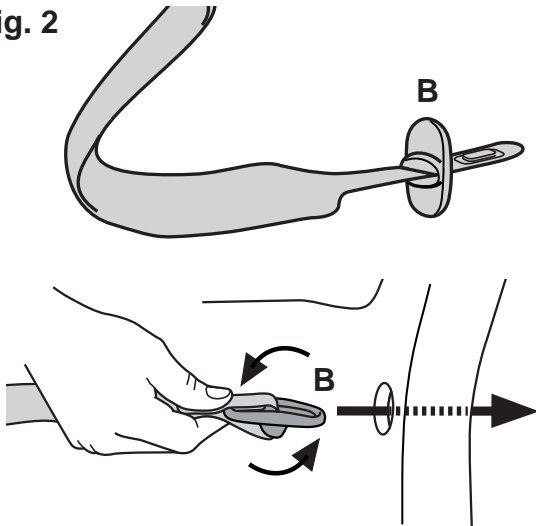

Fig. 3

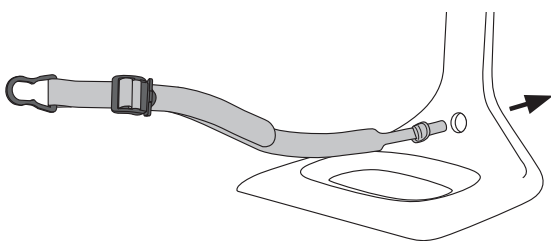
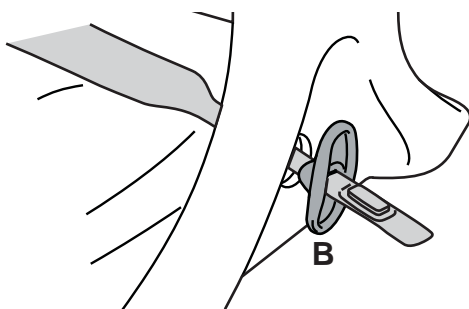
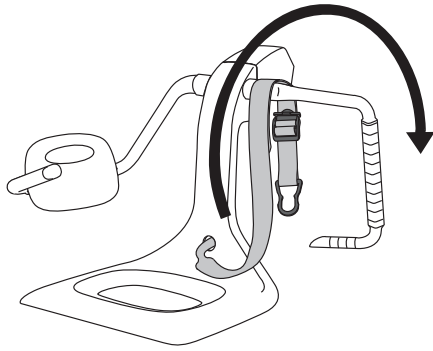

Fig. 4



Continue with the steps on the next page.

Fig. 5



- 5 Fold the hand rest-handle arm backwards. (See Fig. 5)
- 6 Put the belt around the upper part of the hand rest-handle arm. (See Fig. 5)

Fig. 6



- 7 Position the patient on the seat and fold the hand rest-handle arm forward. (See Fig. 6)
- 8 The patient's hands should be placed on the hand rest. (See Fig. 6)
- 9 Place the safety belt around the patient's waist. (See Fig. 6)

Fig. 7

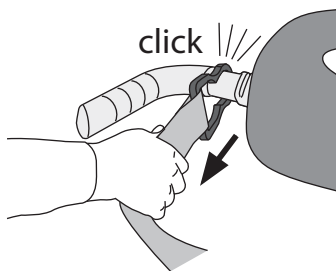

- 10 Fasten the safety belt clip to the backrest-handle arm. (See Fig. 7)

Fig. 8

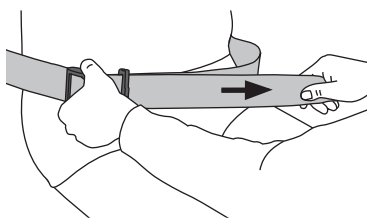

- 11 Tighten the safety belt so that it is close to the patients body. (See Fig. 8)

Fig. 9

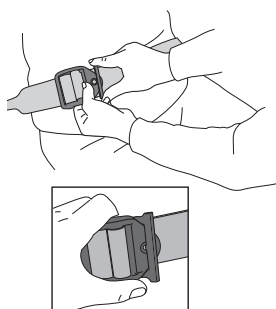

- 12 Lock the safety belt with the lock plate, make sure that the belt strap is tight in the buckle. (See Fig. 9)

Continue with the steps on the next page.

Fig. 10

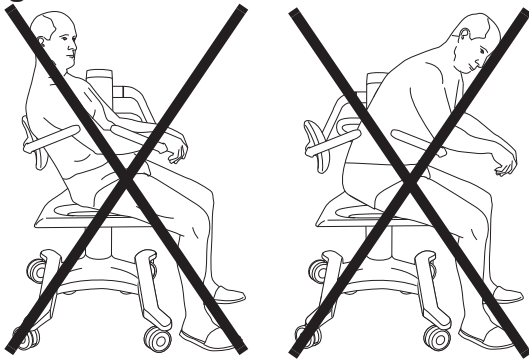

Fig. 11

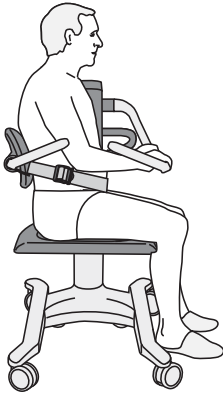

Fig. 12

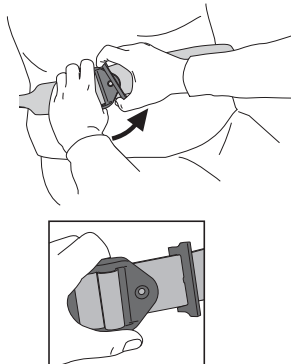
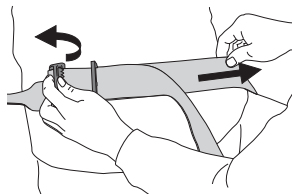

Fig. 13



13 **WARNING**

To avoid falling, make sure that the patient is positioned correctly and that the safety belt is being used, properly fastened and tightened.

WARNING

To avoid the patient from falling out of the device, make sure that the armrest are folded down during transfer.

Make sure the patient is in an upright position in the centre of the seat with his or her:

- buttocks at the back of the seat,
- back against the backrest and
- hands on the hand rest. (See Fig. 10 and 11)

14 When loosen the safety belt, unlock the locking plate and loosen the belt strap. (See Fig. 12 and 13)

NOTE

When the safety belt is not in use, put the safety belts hook end around the top of the hand rest-handle arm.

Make sure that the safety belt do not touch the floor.

Transfer the Patient

WARNING

To avoid entrapment, make sure to keep the patients hair, arms and feet close to the body and use designated grab supports during any movement.

WARNING

To avoid falling, make sure that the patient is positioned correctly and that the safety belt is being used, properly fastened and tightened.

WARNING

To avoid the patient from falling out of the device, make sure that the armrest are folded down during transfer.

Before the patient is transferred to the *Alenti* lift, make sure that:

- the backrest is attached to the correct side of the *Alenti* lift,
- the safety belt is mounted on the *Alenti* lift,
- the patient is undressed and covered.
If using a robe, put it on front to back (opening towards patient's back) and
- the patient is in a correct sitting position.

After each use, disinfect the *Alenti* lift to prevent cross-contamination. See section *Cleaning and Disinfection Instructions* on page 34.

From a Standing Position

(11 steps)

- 1 Activate the brakes on the *Alenti* lift and make sure that they are locked.
- 2 Fold back the hand rest-handle arm.
- 3 Adjust the height of the *Alenti* lift so that the height of the seat is levelled with the back of the patient's knees.
(See Fig. 1)
- 4 Have the patient back up to the *Alenti* lift and feel the chassis gently against his or her hollow of the knees.

Continue with the steps on the next page.

Fig. 1

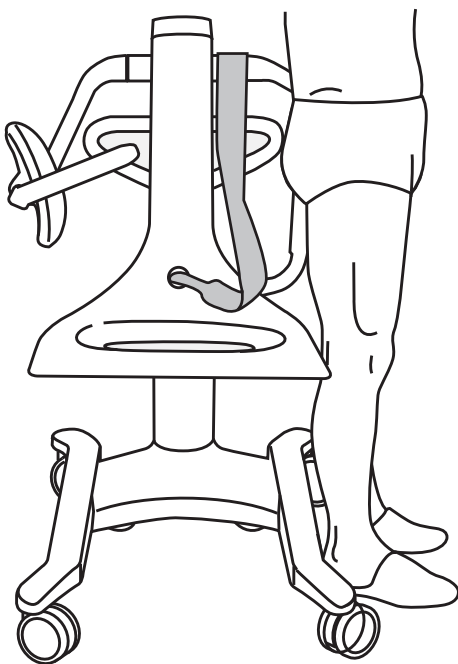
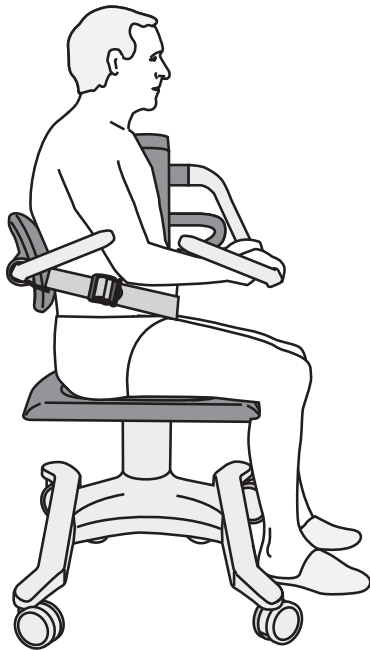

Fig. 2



- 5 Help the patient to sit down.
- 6 Fold forward hand rest-handle arm so that the patient can hold on to it.
- 7 Make sure the patient is in an upright position in the centre of the seat with his or her:
 - buttocks at the back of the seat,
 - back against the backrest and
 - hands on the hand rest. (See Fig. 2)
- 8 Secure the patient with the safety belt. (See Fig. 2)

9

WARNING

To avoid the patient from falling, always make sure that the device is in the lowest possible position before attempting to transfer, dress or undress the patient.

Adjust the *Alenti* lift to an ergonomic height for the caregiver and safe for moving the patient.

- 10 Release the brakes.
- 11 Transfer the patient and the *Alenti* lift to the bathtub using the transfer handles.

To a Standing Position (4 steps)

- 1 Lower the *Alenti* lift until the patient's feet are in contact with the floor.
- 2 Activate the brakes on the *Alenti* lift and make sure that they are locked.
- 3 Fold back the hand rest-handle arm, away from the patient.
- 4 Release the safety belt, put the belt around the upper part of the hand rest-handle arm and help the patient to stand up.

Fig. 3



From a Standing and Raising Aid

(14 steps)

ArjoHuntleigh has compatible standing and raising aids that can be used with the *Alenti* lift. They are *Sara 3000* and *Sara Plus*.

- 1 Fold back the *Alenti* lift hand rest-handle arm.
- 2 Position the standing and raising aid with the patient in front of the *Alenti* lift seat.
- 3 Make sure the *Alenti* lift is as close as possible to the standing and raising aid, with the patient's back towards the *Alenti* lift seat. **(See Fig.3)**
- 4 Activate the brakes on the *Alenti* lift and make sure that they are locked.
- 5 Lower the patient until he or she is sitting on the *Alenti* lift seat. **(See Fig. 3)**
- 6 Unhook the sling.
- 7 Fold forward the *Alenti* lift hand rest-handle arm so that the patient can hold on to it.
- 8 Raise the *Alenti* lift until the patient's feet are free from the standing and raising aid.
- 9 Remove the sling from the patient.

10 **WARNING**

To avoid falling, make sure that the patient is positioned correctly and that the safety belt is being used, properly fastened and tightened.

WARNING

To avoid the patient from falling out of the device, make sure that the armrest are folded down during transfer.

Make sure the patient is in an upright position in the centre of the seat with his or her:

- buttocks at the back of the seat,
- back against the backrest and
- hands on the hand rest.

Continue with the steps on the next page.

Fig. 4

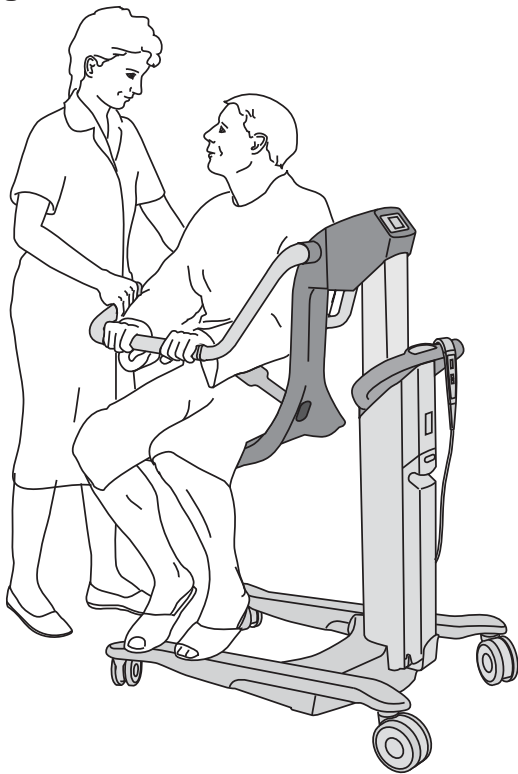

- 11 Secure the patient with the safety belt.
- 12 Remove the standing and raising aid.

13 **WARNING**

To avoid the patient from falling, always make sure that the device is in the lowest possible position before attempting to transfer, dress or undress the patient.

Adjust the *Alenti* lift to an ergonomic height for the caregiver and safe for moving the patient. (See Fig. 4)

- 14 Release the *Alenti* lift brakes.

**To a Standing and Raising Aid
(11 steps)**

- 1 Lower the *Alenti* lift.
- 2 Face patient towards the standing and raising aid.
- 3 Leave the *Alenti* lift brakes unlocked.
- 4 Activate the brakes on the standing and raising aid.
- 5 Fold back the *Alenti* lift hand rest-handle arm, away from the patient.
- 6 Position the patient's feet onto the standing and raising aid foot support.
- 7 Remove the safety belt and put the belt around the upper part of the hand rest-handle arm.
- 8 Put the sling around the patient.
- 9 Attach the sling to the standing and raising aid.
- 10 Gently raise the standing and raising aid.
- 11 Release the brakes of the standing and raising aid and slowly move it and the patient away from the *Alenti* lift.

From Wheelchair

(10 steps)

The *Alenti* lift is compatible with most generic wheelchair models.

For a patient to be able to move from a wheelchair to the *Alenti* lift and vice versa, the patient must be strong enough to move himself or herself sideways and/or be able to stand up.

(See Fig. 5)

WARNING

To avoid falling during transfer, always make sure that the brakes are applied on all equipment being used.

- 1 Apply the brakes on the wheelchair.
- 2 Fold back the *Alenti* lift hand rest-handle arm.
- 3 Position and lower the *Alenti* lift seat so that it is lower than the wheelchair seat. (See Fig. 5)
- 4 Activate the brakes on the *Alenti* lift and make sure that they are locked.
- 5 The patient can now move himself or herself from the wheelchair to the *Alenti* lift.
- 6 Fold forward the *Alenti* lift hand rest-handle arm so that the patient can hold on to it.

7 WARNING

To avoid falling, make sure that the patient is positioned correctly and that the safety belt is being used, properly fastened and tightened.

WARNING

To avoid the patient from falling out of the device, make sure that the armrest are folded down during transfer.

Make sure the patient is in an upright position in the centre of the seat with his or her:

- buttocks at the back of the seat,
- back against the backrest and
- hands on the hand rest. (See Fig. 6)

Continue with the steps on the next page.

Fig. 5

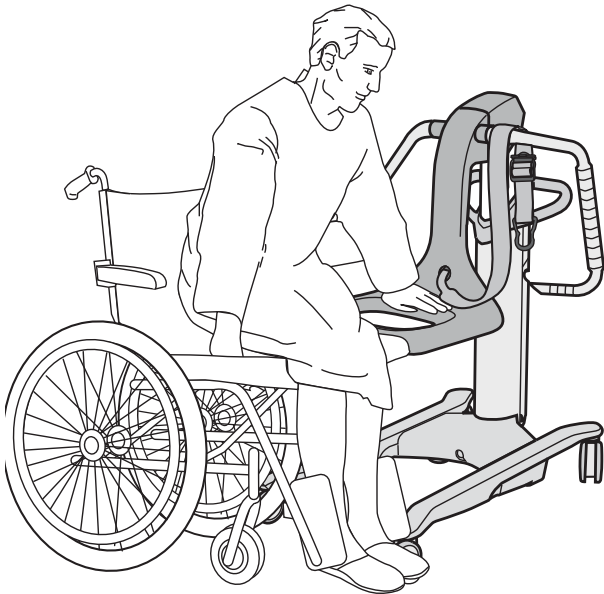
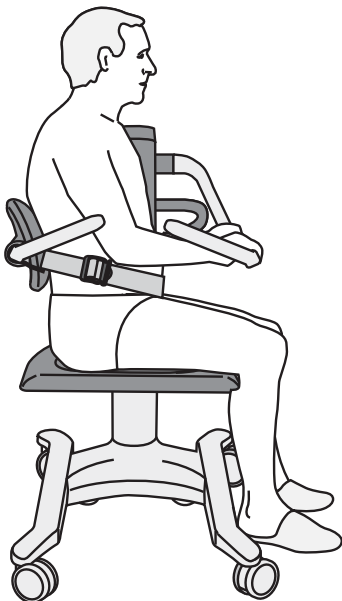

Fig. 6



8 **WARNING**

To avoid the patient from falling, always make sure that the device is in the lowest possible position before attempting to transfer, dress or undress the patient.

Secure the patient with the safety belt.

- 9 Adjust the *Alenti* lift to an ergonomic height for the caregiver and safe for moving the patient.
- 10 Release the *Alenti* lift's brakes.

**To Wheelchair
(6 steps)**

- 1 Position the *Alenti* lift's front towards the side of the wheelchair. (See Fig. 7)
- 2 Adjust the *Alenti* lift to an appropriate height for the transfer. In some cases, it's easier to transfer if the *Alenti* lift seat is higher than the wheelchair seat.
- 3 Activate the brakes on both the *Alenti* lift and the wheelchair.
- 4 Take of the safety belt and put the belt around the upper part of the hand rest-handle arm.
- 5 Fold back the hand rest-handle arm, away from the patient.
- 6 The patient can now transfer seats from the *Alenti* lift to the wheelchair. (See Fig. 7)

Fig. 7



To the Toilet (3 steps)

WARNING

To avoid entrapment or pinching of genitals, make sure there is enough clearance during movement over the bathtub edge, toilet, bedpan or other furniture.

The *Alenti* lift can be used regardless of whether the toilet is attached to the wall or to the floor. (See Fig. 8)

- 1 Position the *Alenti* lift's front directly over the toilet bowl. (See Fig. 9)
- 2 Lower the *Alenti* lift seat and activate the brakes.
- 3 Make sure to disinfect the *Alenti* lift after each use to prevent cross-contamination. (See Fig. 10)
See section *Care and Preventative Maintenance* on page 38.

From Bed - Sitting (11 steps)

The *Alenti* lift is compatible with most generic hospital beds with a clearance of 150 mm (5 7/8").

For the patient to be able to move directly from the bed to the *Alenti* lift and vice versa, the patient must be strong enough to move himself or herself sideways and/or be able to stand up.

WARNING

To avoid falling during transfer, always make sure that the brakes are applied on all equipment being used.

- 1 Make sure that the wheel brakes on the bed are locked.
- 2 Let the patient sit upright on the side of the bed.
- 3 Fold back the *Alenti* lift hand rest-handle arm, away from the patient.

Continue with the steps on the next page.

Fig. 8



Fig. 9



Fig. 10



Fig. 11

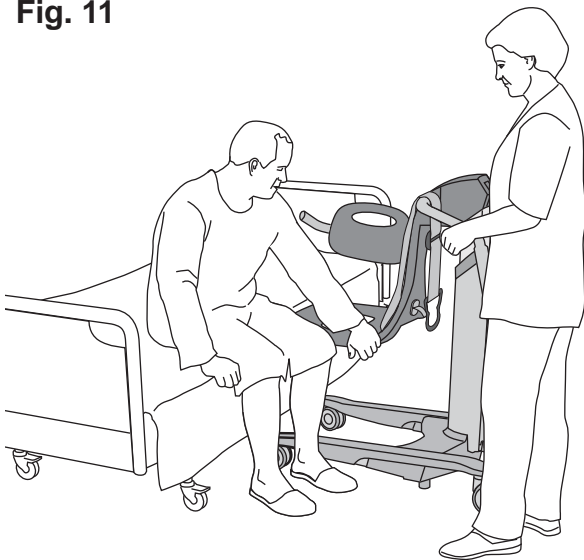

- 4 Position the *Alenti* lift front towards the side of the bed and with the *Alenti* lift seat lower than the bed. (See Fig. 11)
- 5 Activate the brakes on the *Alenti* lift and make sure that they are locked.
- 6 Let the patient move himself or herself from bed to the *Alenti* lift. (See Fig. 12)
- 7 Fold forward the hand rest-handle arm so that the patient can hold on to it.

8 **WARNING**

To avoid falling, make sure that the patient is positioned correctly and that the safety belt is being used, properly fastened and tightened.

Fig. 12

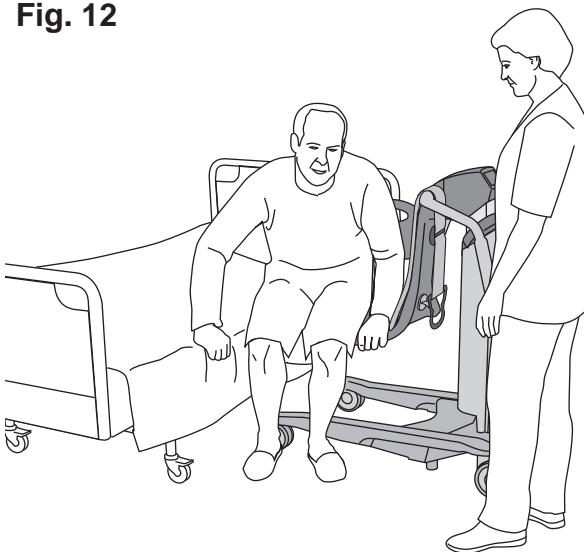

WARNING

To avoid the patient from falling out of the device, make sure that the armrest are folded down during transfer.

Make sure the patient is in an upright position in the centre of the seat with his or her:

- buttocks at the back of the seat,
- back against the backrest and
- hands on the hand rest.

- 9 Secure the patient with the safety belt.
- 10 Release the *Alenti* lift's brakes and move the *Alenti* lift away from the bed.

11 **WARNING**

To avoid the patient from falling, always make sure that the device is in the lowest possible position before attempting to transfer, dress or undress the patient.

Adjust the *Alenti* lift to an ergonomic height for the caregiver and safe for moving the patient.

Fig. 13

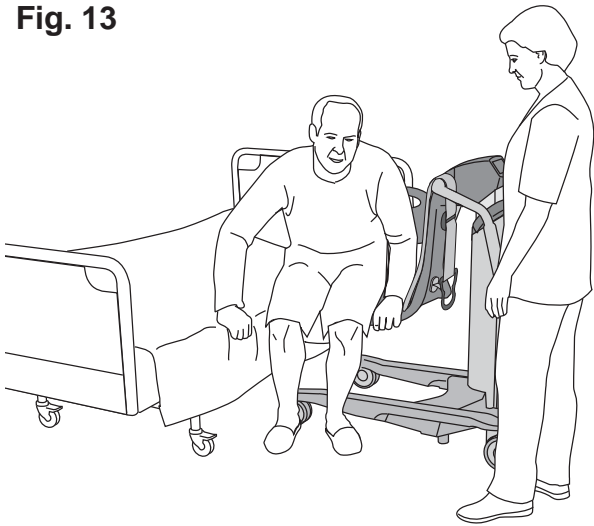

To Bed - Sitting

(8 steps)

- 1 Adjust the *Alenti* lift to an appropriate height for the transfer. In some cases, it's easier to transfer if the *Alenti* lift seat is a little bit higher than the bed.
- 2 Position the *Alenti* lift so that its front is facing the side of the bed. (See Fig. 13)
- 3 Active the brakes on the *Alenti* lift and make sure that they are locked.
- 4 Apply the wheel brakes on the bed.
- 5 Take of the safety belt and put the belt around the upper part of the hand rest-handle arm.
- 6 Fold back the hand rest-handle arm, away from the patient.
- 7 Let the patient move himself or herself to bed from the *Alenti* lift. (See Fig. 14)
- 8 Make sure the patient sits upright at the side of the bed before the *Alenti* lift is pulled away.

Fig. 14

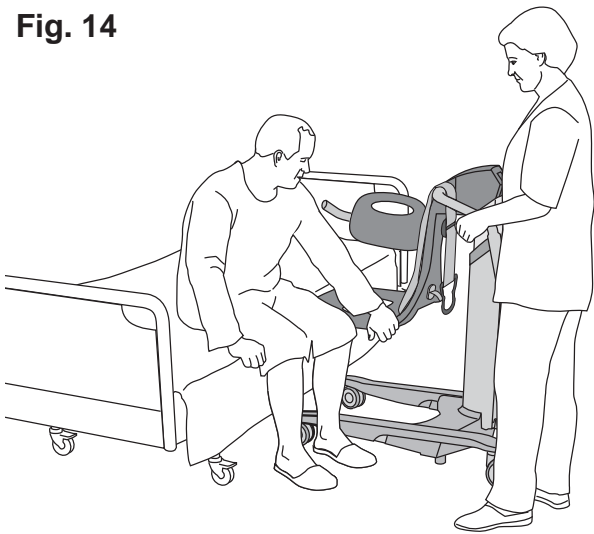

Fig. 15



From Bed - Laying Down

(19 steps)

The *Alenti* lift is compatible with most generic hospital beds with a clearance of 150 mm (5 7/8").

WARNING

To avoid falling during transfer, always make sure that the brakes are applied on all equipment being used.

- 1 Apply the wheel brakes on the bed.
- 2 Drop the bed rail and turn the patient onto his or her side away from the *Alenti* lift. (See Fig. 15)
- 3 Fold back both handle arms to clear the area above the *Alenti* lift's seat
- 4 Position the *Alenti* lift's front over the bed, so the *Alenti* lift seat is on top of the bed, as close to the patient as possible. (See Fig. 15)

Continue with the steps on the next page.

Fig. 16

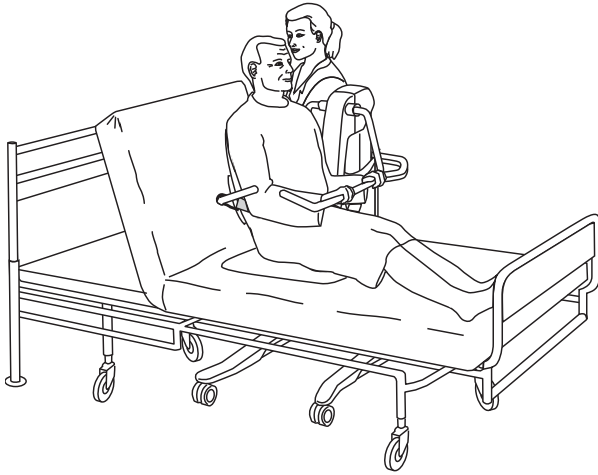

- 5 Lower the seat so that it presses firmly against the bed.
- 6 Activate the brakes on the *Alenti* lift and make sure that they are locked.
- 7 Turn the patient onto his or her back and make sure that he or she is positioned correctly on the seat.
- 8 Fold forward the hand rest-handle arm so that the patient can hold on to it.
- 9 Help the patient to sit upright, either manually or by raising the head end of the bed. (See Fig. 16)
- 10 Lean the patient forward.
- 11 Fold forward the backrest-handle arm and make sure it is behind the patient's back for support.

12 **WARNING**

To avoid falling, make sure that the patient is positioned correctly and that the safety belt is being used, properly fastened and tightened.

WARNING

To avoid the patient from falling out of the device, make sure that the armrest are folded down during transfer.

Make sure the patient is in an upright position in the centre of the seat with his or her:

- buttocks at the back of the seat,
- back against the backrest and
- hands on the hand rest.

Continue with the steps on the next page.

Fig. 17

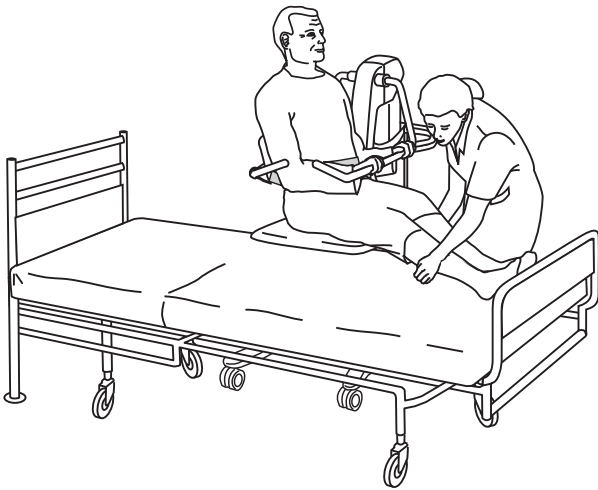

- 13 Secure the patient with the safety belt.
- 14 Raise the *Alenti* lift's seat to a height enough to move the *Alenti* lift away from the bed.
- 15 Release the *Alenti* lift's brakes.
- 16 Pull the *Alenti* lift away from the bed while supporting the patient's legs. (**See Fig. 17**)
- 17 Make sure the *Alenti* lift is completely clear from the bed and other devices.
- 18 Adjust the *Alenti* lift to an ergonomic height for the caregiver and safe for moving the patient.

19 **WARNING**

To avoid the patient from falling, always make sure that the device is in the lowest possible position before attempting to transfer, dress or undress the patient.

The patient should keep his or her hands on the hand rest.

Fig. 18

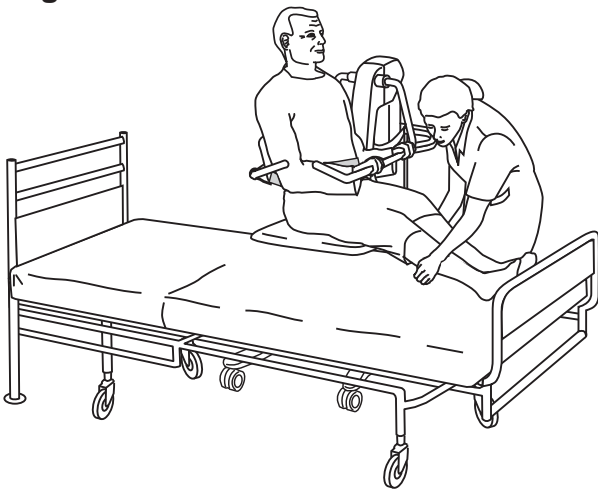

To Bed - Laying Down
(19 steps)

WARNING

To avoid falling during transfer, always make sure that the brakes are applied on all equipment being used.

- 1 Drop the bed rail and apply the wheel brakes on the bed.
- 2 Place a towel on the bed to avoid making the bed wet from the *Alenti* lift seat, if coming from a bath.
- 3 Adjust the *Alenti* lift height to where the seat and genitals clears the bed.
- 4 Move the front of the *Alenti* lift over the bed and grab the patient's legs and lift them onto the bed. (**See Fig. 18**)
- 5 Active the *Alenti* lift's brakes and make sure that they are locked.

Continue with the steps on the next page.

Fig. 19

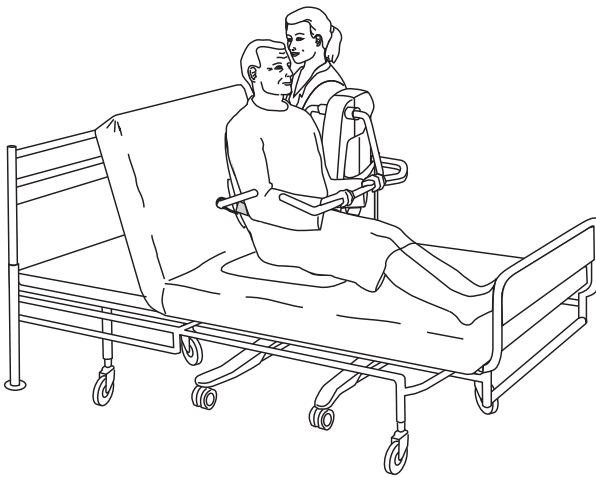

Fig. 20



6 **WARNING**

To avoid entrapment or pinching of genitals, make sure there is enough clearance during movement over the bathtub edge, toilet, bedpan or other furniture.

Lower the *Alenti* lift so that the seat gets pressed firmly on the bed. **Make sure no body parts get pinched between the seat and bed.**

- 7 If needed, raise the head end of the bed to support the patient's back. (See Fig. 19)
- 8 Take off the safety belt and put the belt around the upper part of the hand rest-handle arm.
- 9 Lean the patient forward and place the patient's hands on the hand rest.
- 10 Fold back the backrest-handle arm, away from the patient.
- 11 Assist the patient to lean back against the bed.
- 12 Fold back the hand rest-handle arm.
- 13 If the head end of the bed has been raised, lower it back down.
- 14 Make sure the patient lays down flat on the bed before turning him or her to their side away from the *Alenti* lift and its seat. (See Fig. 20)
- 15 Raise the *Alenti* lift seat to separate it from the bed.
- 16 Release the *Alenti* lift's brakes.
- 17 Move the *Alenti* lift away from bed.
- 18 Roll the patient from the side to his or her back.
- 19 Pull the bed rail up.

Bathe the Patient

Fig. 1

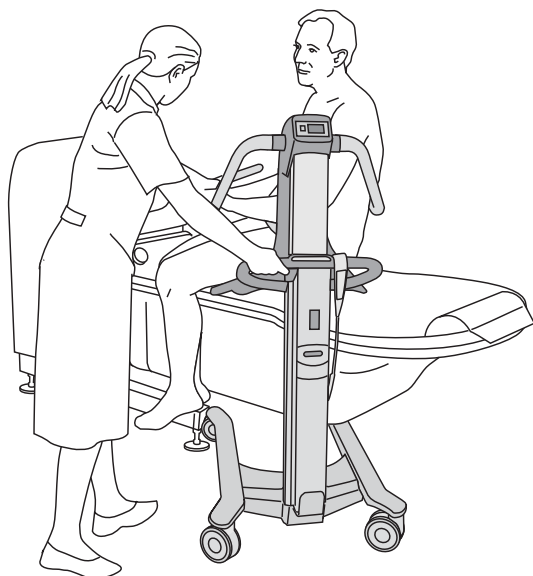

To Bath (14 steps)

WARNING

To avoid entrapment, make sure to keep the patients hair, arms and feet close to the body and use designated grab supports during any movement.

WARNING

To avoid the device in use from tipping, do not raise or lower other equipment close to it and be aware of stationary object when lowering.

The *Alenti* lift is compatible with the ArjoHuntleigh *System 2000* bath range and *Century* baths from year 2004 and up.

- 1 Lower the bathtub to its lowest position.
- 2 Adjust the *Alenti* lift's height to where the seat and genitals clears the bathtub rim.
When adjusting the *Alenti* lift height make sure there is sufficient sideways clearance between the *Alenti* lift and the bathtub.
- 3 Position the *Alenti* lift diagonally to the head end of the bathtub. (See Fig. 1)

4 **WARNING**

To avoid entrapment or pinching of genitals, make sure there is enough clearance during movement over the bathtub edge, toilet, bedpan or other furniture.

Help the patient to move his or her legs over the bathtub rim while rotating the *Alenti* lift in position. (See Fig. 2)

- 5 Let the patient feel the water with his or her feet. Adjust the temperature, if needed.

Fig. 2

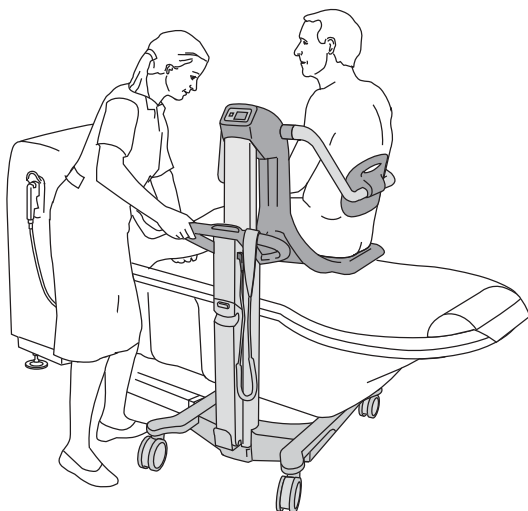

Continue with the steps on the next page.

Fig. 3

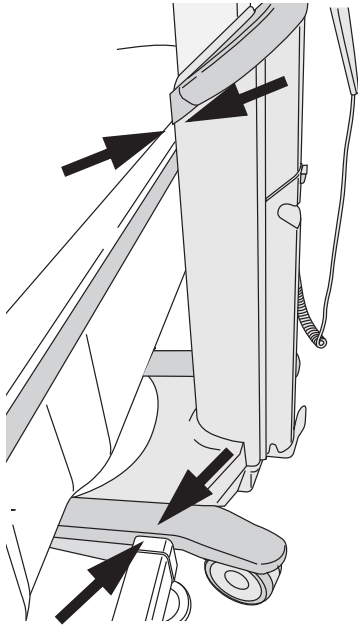

Fig. 4



- 6 Centre the *Alenti* lift over the bathtub until it reaches a stop against the bathtub. Make sure the *Alenti* lift is docked against the bathtub leg and the bathtub rim. (See Fig. 3)
- 7 Adjust the *Alenti* lift to an ergonomic working height.

8 **WARNING**

To avoid entrapment or pinching of genitals, make sure there is enough clearance during movement over the bathtub edge, toilet, bedpan or other furniture.

Raise the bathtub, but make sure no body parts get pinched between the bottom of the bathtub and the seat.

- 9 If the patient desires and is capable, there is the option of folding away both the handles (hand and back), see step 10-13. Otherwise continue to step 14.
- 10 Release the safety belt from the backrest handle and put the belt around the upper part of the hand rest-handle arm.
- 11 Lean the patient forward and place his or her hands on the hand rest.
- 12 Fold back the backrest-handle arm, away from the patient, thus allowing the patient to lean back against the bathtub and the bath pillow. (See Fig. 4)
- 13 Fold back the hand rest handle arm away from the patient.
- 14 Bathe the patient.

Fig. 1

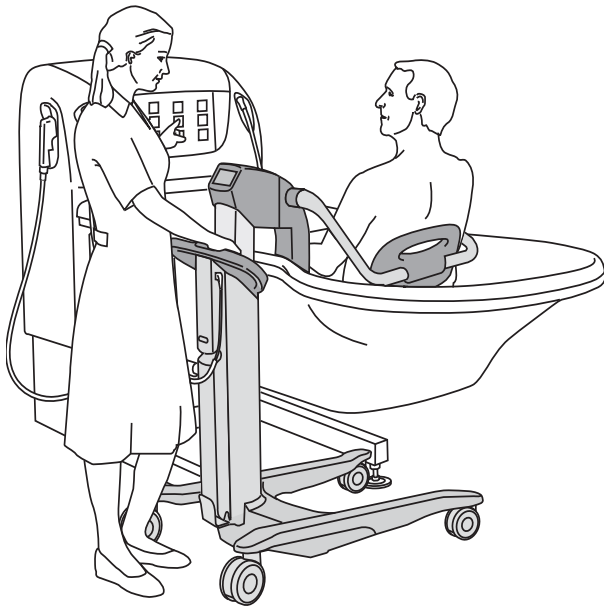

From Bath

(16 steps)

- 1 After bathing, open the drain.
- 2 If the hand rest handle has been folded away, fold it back in front of patient.

3 **WARNING**

To avoid falling, make sure that the patient is positioned correctly and that the safety belt is being used, properly fastened and tightened.

WARNING

To avoid the patient from falling out of the device, make sure that the armrest are folded down during transfer.

Make sure the patient is in an upright position in the centre of the seat with his or her:

- buttocks at the back of the seat,
- back against the backrest and
- hands on the hand rest.

- 4 Lean the patient forward and fold the backrest-handle arm behind the patient. **(See Fig. 1)**
- 5 Secure the safety belt.
- 6 To separate the *Alenti* lift seat from the bottom of the bathtub, lower the bathtub to its lowest position.
- 7 Start the shower and allow the patient to feel the water temperature by hand before directing it on the patient.
- 8 Shower the patient. **(See Fig. 2)**
- 9 Dry the patient and place towels to keep him or her warm and comfortable.

Fig. 2

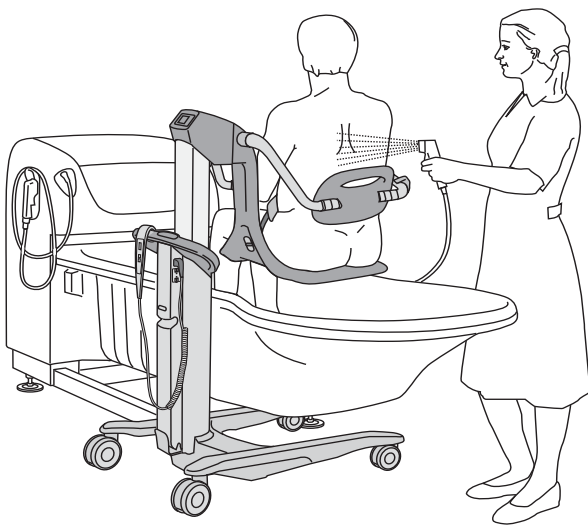

Continue with the steps on the next page.

Fig. 3



Fig. 4



- 10 Make sure that the patient is in an upright position in the centre of the seat.
- 11 Raise the *Alenti* lift to a position where the seat clears the edge of the bathtub rim.

12 **WARNING**

To avoid the patient from falling, always make sure that the device is in the lowest possible position before attempting to transfer, dress or undress the patient.

Shower the patient's feet and dry them. Also dry the underside of the seat, to prevent water from dripping on the floor when moving the *Alenti* lift away from the bathtub.

13 **WARNING**

To avoid entrapment or pinching of genitals, make sure there is enough clearance during movement over the bathtub edge, toilet, bedpan or other furniture.

Help the patient to move his or her legs over the bathtub rim while rotating the *Alenti* lift away from the bathtub. (See Fig. 3)

14 **WARNING**

To avoid the device in use from tipping, do not raise or lower other equipment close to it and be aware of stationary object when lowering.

Make sure the *Alenti* lift is completely clear from the bathtub and other devices to avoid undesired contact between these.

- 15 Lower the *Alenti* lift until the patient's feet are in contact with the chassis.
- 16 Make sure to disinfect the *Alenti* lift after each use to prevent cross-contamination. (See Fig.4) See section *Cleaning and Disinfection Instructions on page 34.*

Cleaning and Disinfection Instructions

For the best results, only use ArjoHuntleigh branded disinfectant.

If you have any questions regarding disinfecting the equipment or wish to order disinfectant (see *Parts and Accessories on page 52*), contact your local ArjoHuntleigh representative.

The following procedure should be carried out after every use and at the end of the day.

WARNING

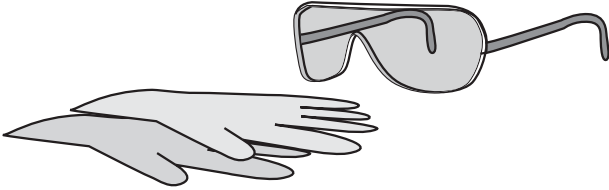

To avoid eye and skin damage, always use protective glasses and gloves. If contact occurs rinse with plenty of water. If eyes or skin becomes irritated, contact a physician. Always read the IFU and the Material Safety Data Sheet (MSDS) of the disinfectant.

WARNING

To prevent cross-contamination, always follow the disinfection instructions in this IFU.

WARNING

To avoid eye or skin irritation, never disinfect in the presence of a patient.

CAUTION

To avoid damage on the equipment only use ArjoHuntleigh branded disinfectants.

Accessories for Disinfecting the Alenti Lift

- Protective gloves
- Protective glasses
- Spray bottle with disinfectant
- Spray bottle with water
- Cloth wet and dry
- Disposable towels
- Soft bristled brush
- Long handled soft bristled brush

Always Follow these 17 Steps for Cleaning and Disinfection

Fig. 1

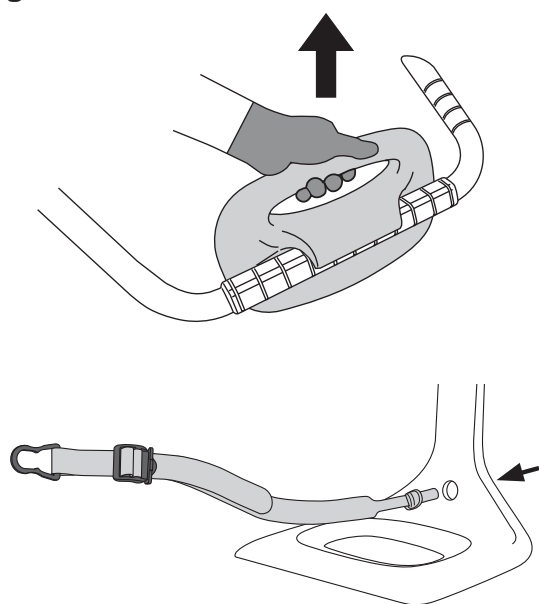

Removing visual residue (step 1-3 of 17)

- 1 Remove the backrest and safety belt and place them at the bottom of the bathtub. (See Fig. 1)
- 2 Position the *Alenti* lift over the bathtub and lower it down.
- 3 Clean:
 - the upper part of the *Alenti* lift (start from top and move downwards)
 - all removed partsfrom visible residue with a cloth soaked in water. Alternatively shower with water using a brush and/or wipe with a cloth.

Cleaning (step 4-11 of 17)

- 4 Put on protective gloves and glasses.
- 5 Most ArjoHuntleigh baths are equipped with a spray handle for disinfecting purposes. Read the bath instructions on how to use the disinfectant. Check the level of the disinfectant.
- 6 If you do not have the integrated disinfection equipment, you can use a spray bottle containing disinfectant mixed according to the printed instructions on the disinfectant bottle.
- 7 Spray disinfectant on (See Fig. 2):
 - the upper part of the *Alenti* lift
 - all removed partsUse a brush soaked in disinfectant and scrub thoroughly, especially on handles and hand control.
- 8 Shower with water (approx. 25 °C (77 °F)) or spray with plenty of water and wipe off with a clean cloth to remove all disinfectant.
- 9 Soak a cloth in disinfectant and wipe all other areas of the *Alenti* lift, such as chassis.
- 10 Wet a new cloth with water and remove all traces of disinfectant from all other areas of the *Alenti* lift. The cloth should occasionally be rinsed in running water when removing disinfectant.
- 11 If all disinfectant cannot be removed, spray water on the affected part and wipe off with disposable towels. Repeat until all disinfectant has been removed.

Fig. 2

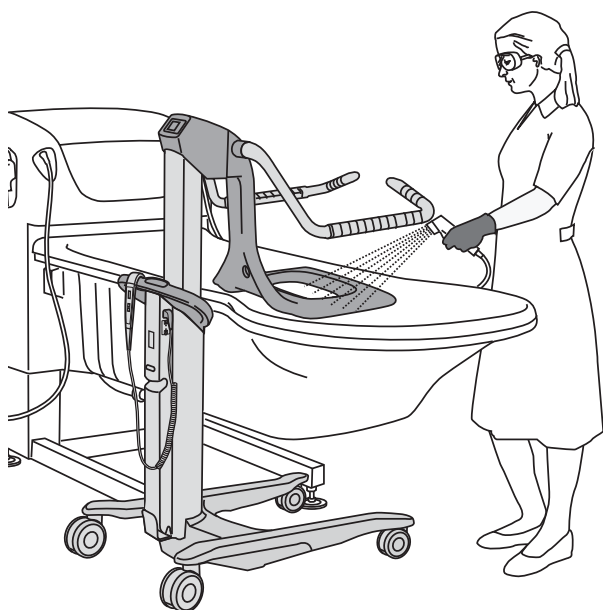

Continue with the steps on the next page.

Disinfection (step 12-17 of 17)

12 Spray disinfectant on:

- the upper part of the *Alenti* lift
- all removed parts

13 Soak a cloth in disinfectant and wipe all other areas of the *Alenti* lift, such as chassis.

14 Allow a disinfection time according to the instructions on the disinfectant bottle label.

15 Spray or shower water (approx. 25 °C (77 °F)) and wipe with a clean cloth to remove all traces of the disinfectant on:

- the upper part of the *Alenti* lift
- all removed parts
- all other areas of the *Alenti* lift, such as chassis

The cloth should occasionally be rinsed in running water during removal of disinfectant. (See Fig. 3)

16 If all disinfectant cannot be removed, spray water on the affected part and wipe off with disposable towels. Repeat until all disinfectant has been removed.

17 Let all parts dry.

Fig. 3

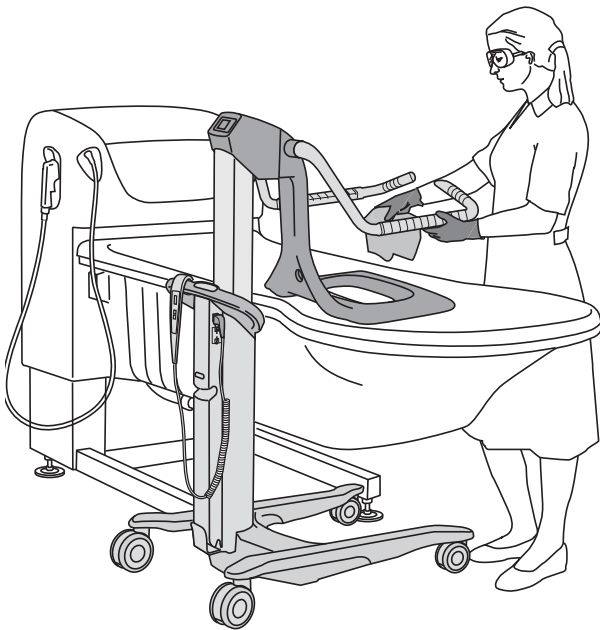

Battery Instructions

WARNING

To avoid bodily injury, do NOT crush, puncture, open, dismantle or otherwise mechanically interfere with the battery.

- **Should the battery casing crack and cause contents to come in contact with skin or clothing, rinse immediately with plenty of water.**
- **If contents come in contact with the eyes, rinse immediately with plenty of water and seek medical attention.**
- **Inhalation of the contents can cause respiratory irritation. Provide fresh air and medical attention.**

- Be careful not to drop the battery.
- Contact the appropriate local authority for advice when disposing of batteries.
- Check label on the battery.

Low Charge Warning

A buzzer sound will go off when the battery reaches a low charge. The battery should then be recharged as soon as possible.

Storage of Battery

- The battery is delivered charged but we recommend you to recharge the battery when received due to a slow self discharge.
- The battery will slowly self discharge when not used.
- A battery in storage and transport and should be in a temperature range of -0 °C to +30 °C (32 °F to 86 °F), cooler temperatures will extend its service life.
- For maximum battery performance do not store the battery above 50 °C (122 °F).

Installation of charger:

See *NDA-X200, Battery Charger IFU*.

How to change the battery:

See *NDA-X200 Battery Charger IFU*.

Care and Preventative Maintenance

The *Alenti* lift is subject to wear and tear, and the following actions must be performed when specified to make sure that the product remains within its original manufacturing specification.

WARNING

To avoid malfunction resulting in injury, make sure to conduct regular inspections and follow the recommended maintenance schedule. In some cases due to heavy use of the product and exposure to aggressive environment more frequent inspections should be carried out. Local regulations and standards may be more stringent than this recommended maintenance schedule.

NOTE

Product cannot be maintained and serviced while in use with the patient

PREVENTIVE MAINTENANCE SCHEDULE

CAREGIVER OBLIGATIONS Action/Check	Every DAY	Every WEEK	Every 2nd YEAR
Disinfect	X		
Check of mechanical attachments		X	
Visually check the safety belt/leg strap		X	
Check hand control and cable		X	
Check and clean castors		X	
Check brake function and brake pads		X	
Visually check battery charger and battery		X	
Visually check all exposed parts		X	
Check for corrosion and damage		X	
Perform functionality test		X	
Replace safety belt			X

WARNING

To avoid injury to both the patient and the caregiver, never modify the equipment or use incompatible parts.

Fig. 1



Caregiver Obligations

Caregiver obligations shall be carried out by personnel with sufficient *Alenti* lift knowledge following the instructions in this *IFU*.

Every Day

- **Disinfect.** The *Alenti* lift has to be disinfected immediately after every use. ArjoHuntleigh disinfectants should be used in recommended concentrations. See section *Cleaning and Disinfection Instructions* on page 34.

Every Week

- **Check the mechanical attachments** by placing a foot on the chassis and pull the seat upwards with both hands. (See Fig. 1)
No gaps between the chassis and seat are allowed.

Fig. 2

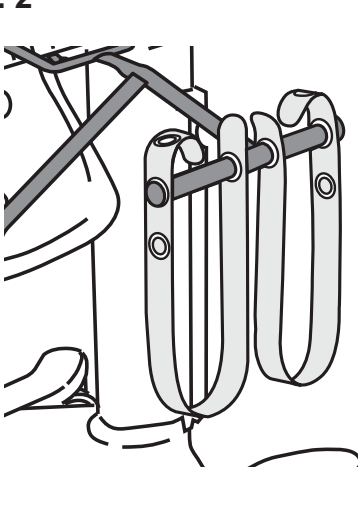

- **Visually check the safety belt and leg straps.** Check the complete length for fraying, cuts, cracks, tears, that no inner fabric is showing and that no other damage is visible. (See Fig. 2)

If the safety belt is damaged in any way, replace it.

- **Check hand control and cable:** Visually check the condition of the hand control and its cable. If it is cut or damaged, replace it. (See Fig. 3)

Fig. 3

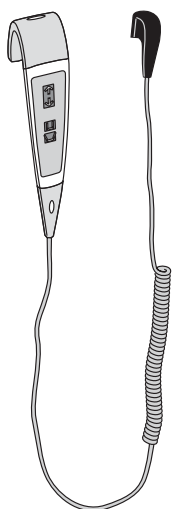

Fig. 4

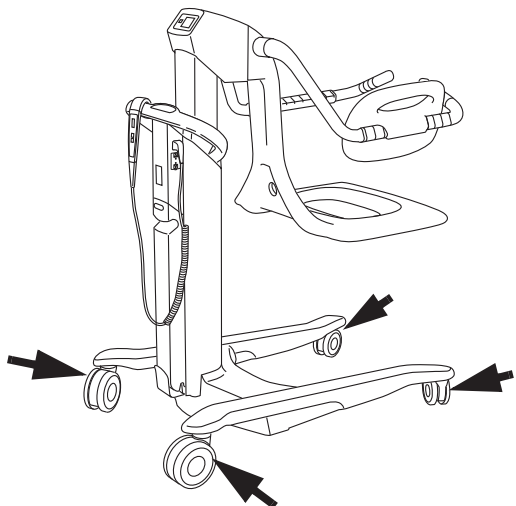

Fig. 5

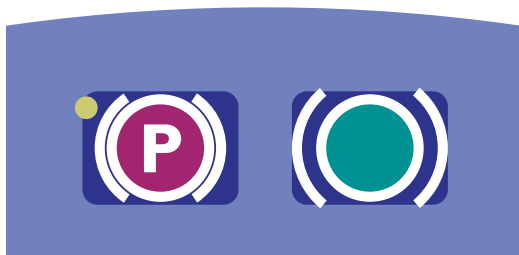
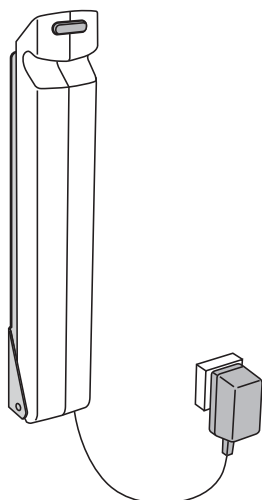

Fig. 6



- **Check that the castors are properly fixed** and are rolling and swivelling freely. (See Fig. 4)
Clean with water (the function can be affected by soap, hair, dust and chemicals from floor cleaning).
- **Check the central brake function and brake pads** by activating the brakes and try to move the *Alenti* lift. Make sure the *Alenti* lift does not move back and forward once the brakes are applied. (See Fig. 5)
- **Visually check the condition of the battery charger**, its cable and the battery. (See Fig. 6)
Withdraw and replace immediately if damaged.
- **Visually check all exposed parts**, especially where personal contact is made by either the patient or caregiver. Make sure no cracks or sharp edges have developed that could cause the patient or caregiver injury or that has become unhygienic. Replace damaged parts.
- **Check for corrosion and damage:** if there is any visible corrosion or damage on parts, contact your local ArjoHuntleigh representative for support.
- **Perform a functionality test:**
Test up and down motion by pressing the up and down button on the hand control and control panel. Also test the Emergency High/Low and brakes.

Yearly

- The *Alenti* lift has to be serviced according to the Preventive Maintenance Schedule (Qualified Personnel Action/Check).

WARNING

To avoid injury and/or unsafe product, the maintenance activities must be carried out at the correct frequency by qualified personnel using correct tools, parts and knowledge of procedure. Qualified personnel must have documented training in maintenance of this device.

QUALIFIED PERSONNEL Action/Check	Every YEAR	Every 2nd YEAR
Replace brake pads	X	
Perform a safe working load test (local requirements)	X	
Lubricate inner profile	X	
Check battery and battery charger	X	
Check scale calibration (if attached and not verified)	X	
Check all vital parts for corrosion/damage	X	
Perform full feature functionality test	X	
Check mechanical attachments	X	
Check that the latest upgrades have been implemented	X	
Check the safety stop function	X	
Check the emergency High/Low function	X	
Inspect castors	X	
Replace guide pieces, lower bushing and outer profile seal		X
Replace the plastic cross on the actuator		X

NOTE

All checkpoints in table *CAREGIVER OBLIGATIONS Action/Check on page 38* are to be checked when performing the checkpoints in table *QUALIFIED PERSONNEL Action/Check on page 41*.

Troubleshooting

PROBLEM	ACTION
The <i>Alenti</i> lift raises or lowers after the hand control button or the control panel button is released.	<ol style="list-style-type: none"> 1 Pull the battery out and remove the patient from the <i>Alenti</i> lift. 2 Remove the hand control and put the battery back. If the failure is gone, replace the hand control. 3 If the failure still occurs, contact qualified personnel.
The <i>Alenti</i> lift does not raise or lower when the hand control button or the control panel button is pressed.	<ol style="list-style-type: none"> 1 Make sure the battery is connected correctly to the <i>Alenti</i> lift. 2 Make sure the battery has sufficient charge, the battery charger lamp located on the <i>Alenti</i> lift turns green when the battery is fully charged. 3 Make sure the <i>Alenti</i> lift has not been lowered onto a fixed object. If this occurs the automatic safety stop function will turn on. 4 Use the Emergency High/Low to remove patient from the <i>Alenti</i> lift. Contact qualified personnel.
The <i>Alenti</i> lift functions only operate with the use of the control panel, not the hand control.	<ol style="list-style-type: none"> 1 Make sure that the hand control connection is properly connected to the socket. 2 If the problem persists, replace the hand control.
The <i>Alenti</i> lift raises and stops by itself.	Make sure that the safe working load of 182 kg (400 lbs) is not exceeded. The lowering function will still operate during this scenario.
The <i>Alenti</i> lift is hard to manoeuvre.	<ol style="list-style-type: none"> 1 Make sure that the brakes are released. 2 Make sure that the castors roll and swivel freely. If not, remove the patient from the <i>Alenti</i> lift and contact qualified personnel.
If the brakes are not functioning.	<ol style="list-style-type: none"> 1 Make sure that the <i>Alenti</i> lift is flat on a levelled surface (floor surface must not exceed a slope ratio of 1:50). 2 If the brake alarm sounds, try moving the <i>Alenti</i> lift to a flat levelled surface and re-apply brakes. If the alarm continues, contact qualified personnel.
If the optional integrated scale is not operating.	<ol style="list-style-type: none"> 1 Make sure the battery is connected correctly to the <i>Alenti</i> lift. 2 Make sure the battery has sufficient charge. The battery charger lamp located on the <i>Alenti</i> lift turns green when the battery is fully charged. 3 If the problem persists, contact qualified personnel.
The scale is showing TILT.	<ol style="list-style-type: none"> 1 Make sure the <i>Alenti</i> lift is on a flat levelled surface. 2 If the problem persists, contact qualified personnel.
The scale is showing no other error codes than TILT.	Contact qualified personnel.
It is only possible to lower the lift.	The lifting device of this equipment is equipped with a safety nut. If the safety nut will be activated it will only be possible to lower the equipment into a safe position. In case of this scenario stop using the equipment and contact authorized service personnel for repair of the equipment.

Alarms

ALARM	ACTION
The <i>Alenti</i> lift has three different alarm signals which indicate different faults.	
1 Low battery signal	If the raise button (up arrow) is pressed the alarm will sound for up to 10 s at rate of one beep per second. Recharge the battery. If the alarm continues contact your local ArjoHuntleigh service technician.
2 Brake fault	If any of the buttons are pressed the alarm will sound for up to 10 s at a rate of 4 beeps per second. The LED on the control panel and the hand control will also light up. This alarm indicates a brake failure. Try moving the <i>Alenti</i> lift to a flat levelled surface and re-apply brakes. If the alarm continues contact your local ArjoHuntleigh service technician.
3 Circuit board fault	This alarm will continue to sound up to 5 s at a rate of 4 beeps per second, followed by a 30 s pause. The alarm can only be stopped by removing the battery. This alarm indicates a fault in the circuit board. If the alarm starts while the patient is using the <i>Alenti</i> lift, complete the immediate task such as bathing or transfer. Then contact your local ArjoHuntleigh service technician.

NOTE

If the problem can not be solved with the written troubleshooting actions, please contact an ArjoHuntleigh authorized service technician.

Technical Specifications

Alenti lift hygiene chair Model CDB 81XX	
Safe Working Load (SWL) (Max patient weight)	182 kg (400 lbs.)
Weight of lift	67 kg (148 lbs.)
Maximum weight of lift (lift, power drive and scale)	72 kg (159 lbs)
Colour	Grey/ bordeaux-red/blue
Medical equipment	Type 
Sound level	< 65 dB A
Mode of operation	ED maximum 10%; Maximum 2 minutes ON; Minimum 18 minutes OFF
Operating forces of controls	2.7 N
Battery No. NDA0100-XX	Sealed lead-acid battery 24 V, 4 Ah
Battery charger	NDA 1200-EU, NDA 2200-GB, NDA 4200-US, NDA 6200-AU and NDA8200-INT
Protection class	IP X4
Insulation class	Class II
Degree of fire protection	In accordance with standard EN/ISO 60601-1
Pollution degree	2

Operation, transport and storage	
Ambient temperature range	Operation +10 °C to +40 °C (+ 50 °F to 104 °F) Transport and Storage -10 °C to +50 °C (+14 °F to +122 °F)
Relative humidity range	30% - 75% Operation 10% - 80% Transport and Storage
Atmospheric pressure range	700 - 1060 hPa Operation 500 - 1060 hPa Transport and Storage

Allowed combinations	
The <i>Alenti</i> lift integrates with the following products:	ArjoHuntleigh equipment: Sara 3000, Sara Plus, System 2000, Malibu 1600 and Malibu 1700
	Generic Wheel Chair: Most models
	Generic Hospital Beds: Most models with min bed to floor clearance 150 mm
No other combinations are allowed.	

Recycling

The device should be recycled according to national regulations

Package	Wood, corrugated cardboard and plastic are recyclable
The Lift and charger	Electric, steel and plastic parts shall be separated and recycled according to (WEEE).

Disposal of the Alenti lift

Lift	The device is marked with the WEEE symbol to indicate that it is electronic equipment covered by the Directive 2002/96/EC on waste electrical and electronic equipment. In European countries the crossed out wheeled-bin WEEE symbol reminds you that all the electrical and electronic products, batteries and accumulators must be taken to separate collection at end of their working life. This requirement applies in the European Union. Do not dispose these products as unsorted municipal waste. You can return your device and accessories to ArjoHuntleigh or you can contact your local authorities for advice on disposal.
------	---

NOTE

All material used in the *Alenti* lift complies with established biocompatibility standards and have been tested accordingly (ISO 10993-5).

The body supporting material in the seat and backrest is PUR (polyurethane).

Dimensions

mm (inches)

Stroke: 590 mm (23 1/4")

Minor measurement deviations might occur between products.

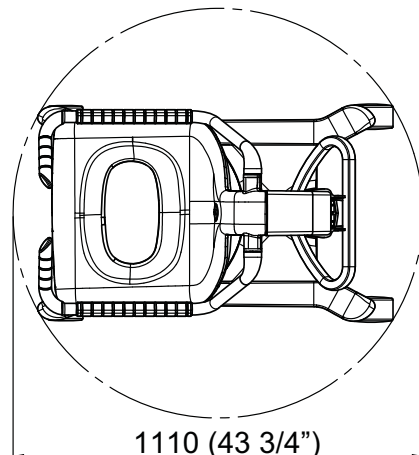
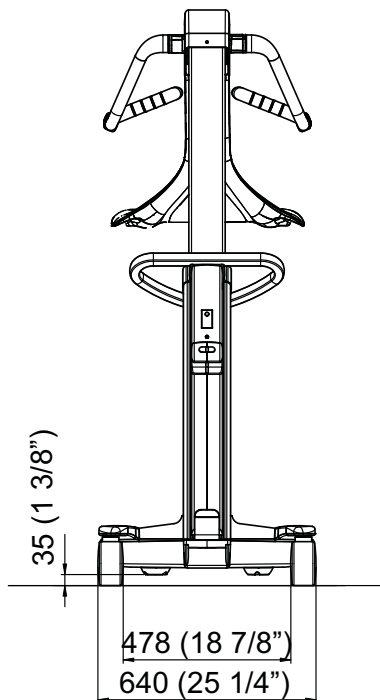
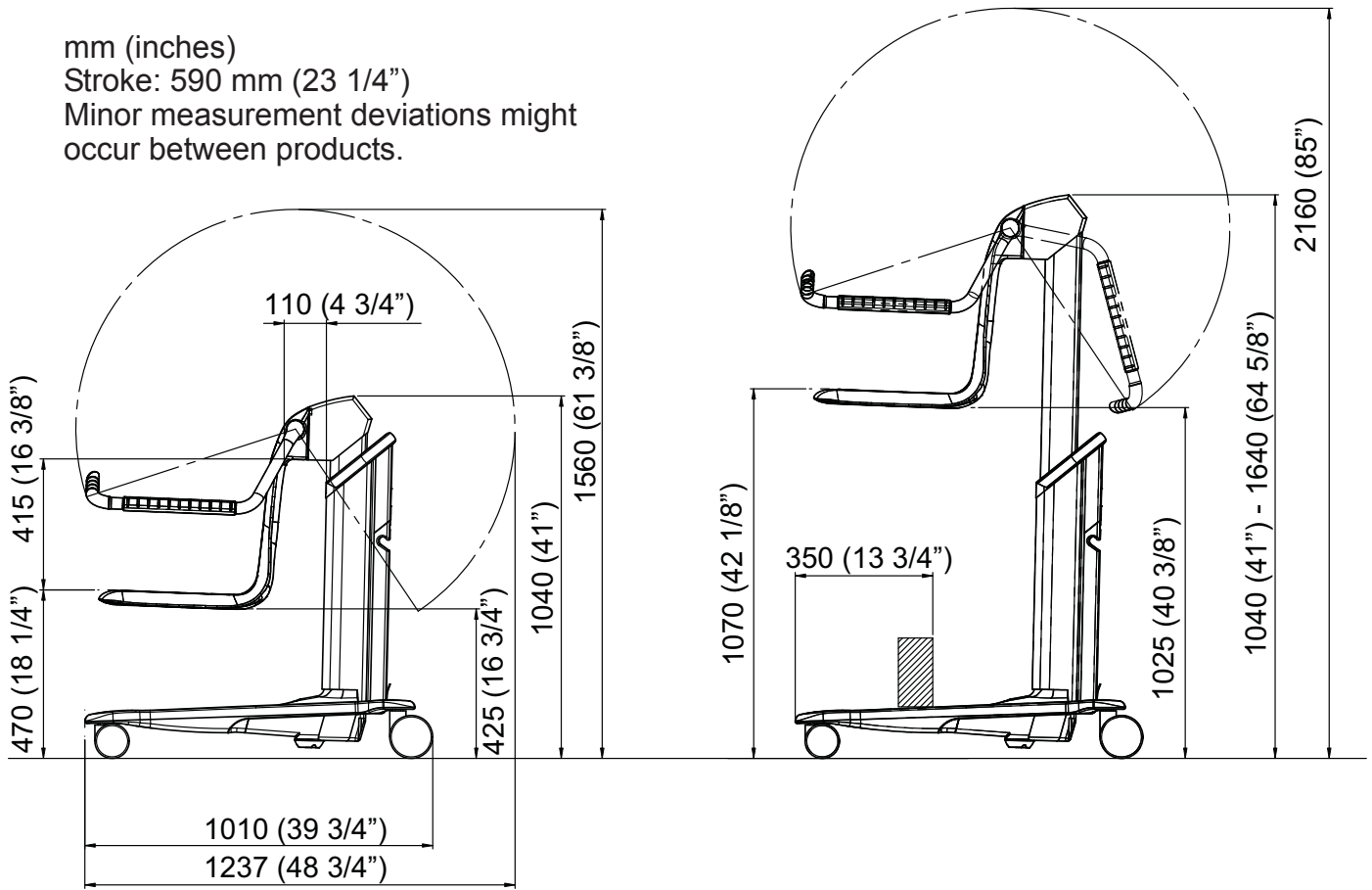

List of Standards and Certificates







STANDARD/CERTIFICATE	DESCRIPTION
EN/IEC 60601-1:2005 AMD1:2012	Medical Electrical Equipment - Part 1: General Requirements for Basic Safety and Essential Performance
ANSI/AAMI ES60601-1 (2005) AMD 1 (2012)	Medical Electrical Equipment - Part 1: General Requirements for Basic Safety and Essential Performance
CAN/CSA-C22.2 No. 60601-1:14	Medical Electrical Equipment - Part 1: General Requirements for Basic Safety and Essential Performance
ISO 10535:2006	Hoists for the transfer of disabled persons -- Requirements and test methods



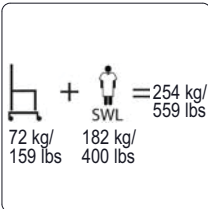

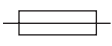





Labels on the Alenti Lift

Label explanation

Battery Label	States safety and environmental information for the battery.
Data Label	States technical performance and requirements, e.g. Input Power, Input Voltage and maximum Patient Weight etc.
Identification Label	States the product identification, serial number and year and month of manufacturing.

Symbol explanation

SWL	Safe Working Load
	Total mass of equipment including its safe working load.
	Lifting stroke 590 mm (23 1/4")
24V DC	Supply voltage
MAX: 200 VA	Maximum power
	Fuse F1 - F10AL 250 V Fuse F2 - T2.5AL 250 V
IP X4	Degree of Protection (i.e. the product is protected against splashing water)
	Type B Applied part: protection against electrical shock in accordance with IEC 60601-1
ED MAX 10%	Mode of operation for Hi/Lo function: ED maximum 10%; Maximum 2 minutes ON; Minimum 18 minutes OFF
NDA0100-XX	Product number of the battery
	CE marking in accordance with Medical Devices Directive 93/42/EEC.
	A battery is the power source of this equipment.

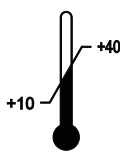
	Read the <i>IFU</i> before use
	Separate electrical and electronic components for recycling in accordance with the European Directive 2012/19/EU (WEEE)
	Classified by Underwriters Laboratories Inc. with respect to electrical shock, fire, mechanical, hazards and other specified hazards only in accordance with the Approvals and List of Standards.
	Environmental danger - contains lead. Not for disposal
	Recyclable
	Name and address of the manufacturer
	Manufacturing date
Max	Maximum capacity of the weighing instrument
Min	Minimum capacity of the weighing instrument
e	Verification scale interval
	Metrology mark, indicating compliance with Directive 2014/31/EU (NAWI) yy = year (For Class III scales only)
	Model number
	Serial number
	Indicates min / max temp for use of weigh scales

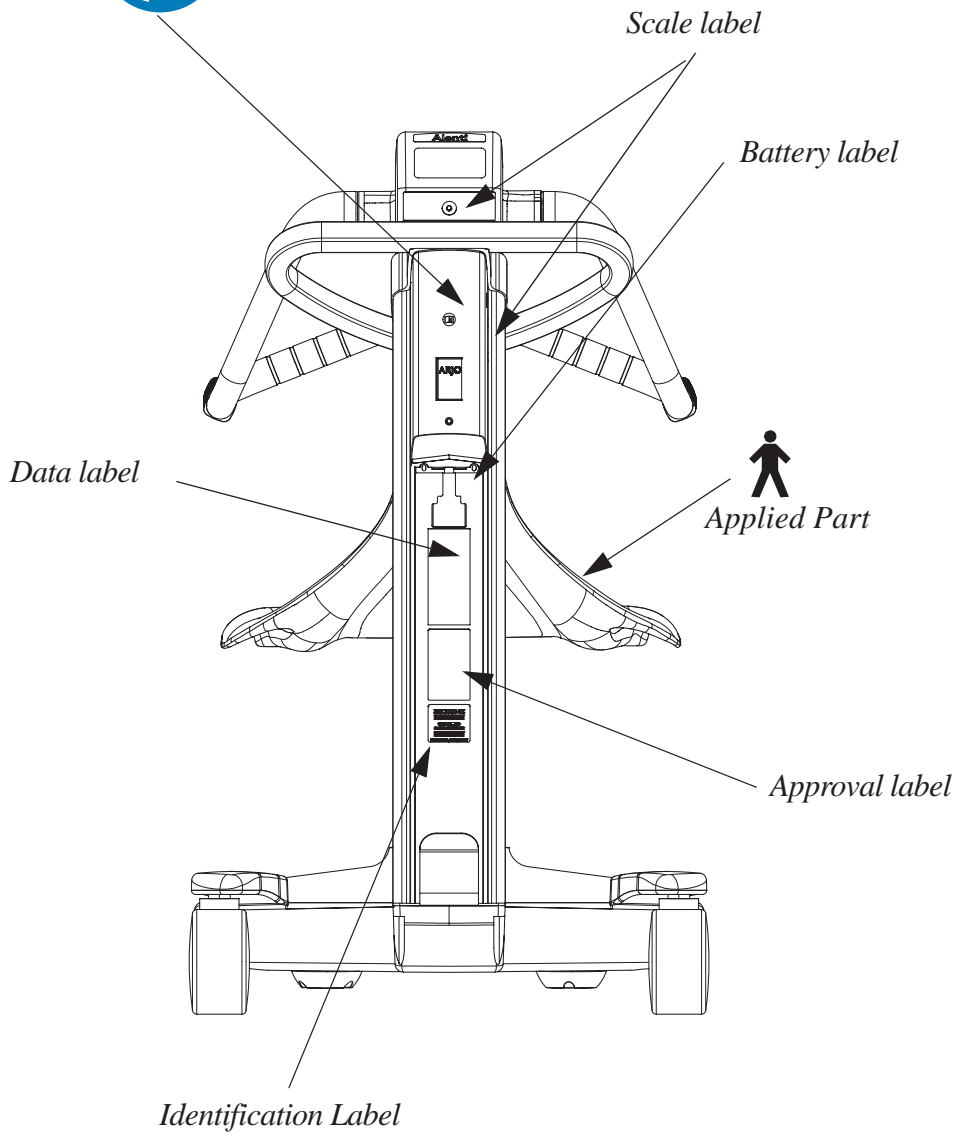

Electromagnetic Compatibility

Medical electrical equipment needs special precautions regarding EMC (Electromagnetic compatibility) and needs to be used according to the EMC information below.

The *Alenti* lift is intended for use in the electromagnetic environment specified below. The customer or the user of the *Alenti* lift should assure that it is used in such an environment.

WARNING

Stacking or placing other electrical equipment next to this device is not recommended, it can interfere with the equipment's operation and safety. Portable and mobile radio-frequency (RF) communications equipment can interfere with this equipment operation and safety.

WARNING

The equipment may cause radio interference or may disrupt the operation of nearby equipment. It may be necessary to take action, such as reorienting, relocating the equipment or shielding the location.

Guidance and manufacturer's declaration - electromagnetic emissions

Emissions test	Compliance	Electromagnetic environment - guidance
RF emissions CISPR 11	Group 1	The <i>Alenti</i> lift uses RF energy only for its internal function. Therefore, its RF emissions are very low and are not likely to cause any interference in nearby electronic equipment.
RF emissions CISPR 11	Class B	The <i>Alenti</i> lift is suitable for use in all establishments, those directly connected to the public low-voltage power supply network that supplies buildings used for domestic purposes.
EN 61000-4-8	3A/m at 50/60 Hz	Magnetic Immunity: If functional disturbance occurs on the <i>Alenti</i> lift it may be necessary to move the <i>Alenti</i> lift further from the source of power frequency magnetic field. The power frequency magnetic field should be measured in the intended use locations to assure that it is sufficiently low.

Guidance and manufacturer's declaration - electromagnetic immunity			
Immunity test	IEC 60601-1-2 test level	Compliance	Electromagnetic environment - guidance
Electrostatic discharge (ESD) IEC 61000-4-2	6 kV contact 8 kV air	6 kV contact 8 kV air	Floors should be wood, concrete or ceramic tile. If floors are covered with synthetic material, the relative humidity should be at least 30%.
Radiated RF IEC 61000-4-3	3 Vrms 80 MHz to 2.5 GHz	10 Vrms 80 MHz to 2.5 GHz	Portable and mobile RF communications equipment should be used no closer to any part of the <i>Alenti</i> lift, including cables, than 1 meter if the transmitters output power rating exceeds 1 W. Field strengths from fixed RF transmitters, as determined by an electromagnetic site survey, ^a should be less than the compliance level in each frequency range. ^b Interference may occur in the vicinity of equipment marked with the following symbol: ((())) 
EN ISO 10535:2006	10 v/m	10 v/m	
<p>a) Field strengths from fixed transmitters, such as base stations for radio (cellular/cordless) telephones and land mobile radios, amateur radio, AM and FM radio broadcast and TV broadcast cannot be predicted theoretically with accuracy. To assess the electromagnetic environment due to fixed RF transmitters, an electromagnetic site survey should be considered. If the measured field strength in the location in which the <i>Alenti</i> lift is used exceeds the applicable RF compliance level above, the <i>Alenti</i> lift should be observed to verify normal operation. If abnormal performance is observed, additional measures may be necessary.</p> <p>b) Over the frequency range 150 kHz to 80 MHz, field strengths should be less than 1 V/m.</p>			

Recommended separation distances between portable and mobile RF communications equipment and the *Alenti* lift. The *Alenti* lift is intended for use in an electromagnetic environment in which radiated RF disturbances are controlled. The customer or the user of the *Alenti* lift can help prevent electromagnetic interference by maintaining a minimum distance between portable and mobile RF communications equipment (transmitters) and the *Alenti* lift by maintaining a distance of not less than 1 meter to any part of the *Alenti* lift, including cables, if the transmitters output power rating exceeds 1 W.

Parts and Accessories

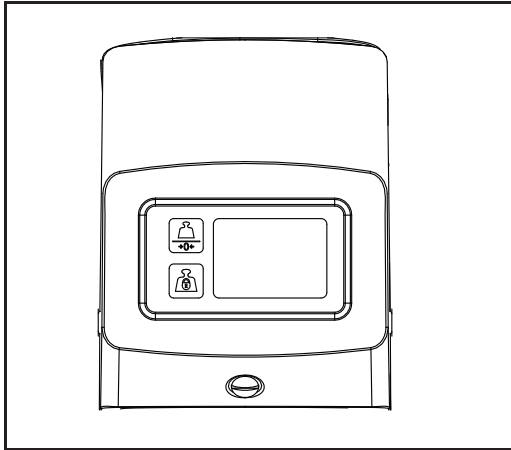

CDA2100-01
Electronic Scale

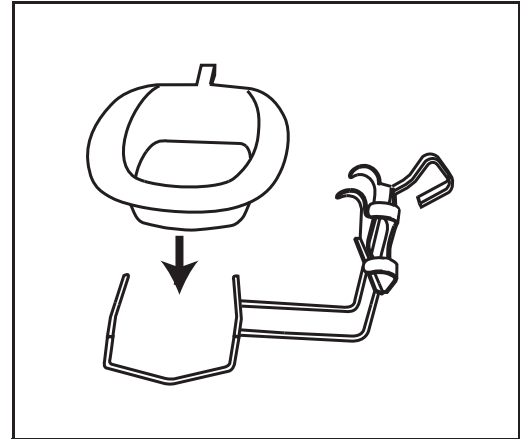

CDA1500-7 Bedpan
CDA1104-90 Bedpan holder

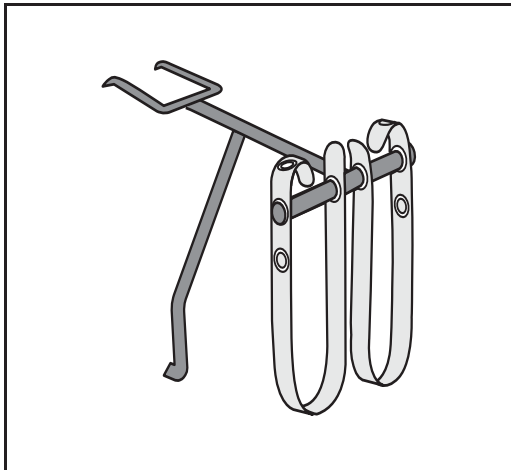

CDA1300-04
Leg support and leg straps

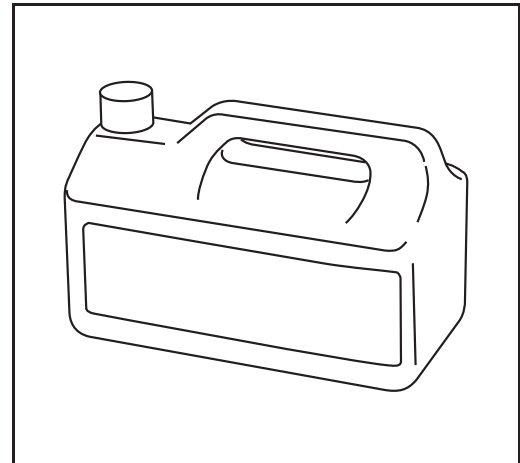

For disinfectant contact the
ArjoHuntleigh local representative

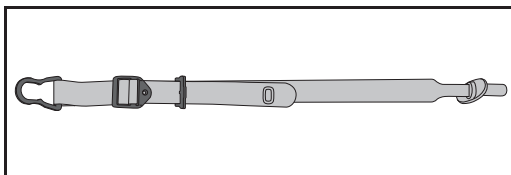

CDA1450-035
Safety belt

Intentionally left blank

Intentionally left blank