

# SQUARE GLOW



User Manual

Powered by 

# CONGRATULATIONS ON YOUR PURCHASE!

This user manual will help you assemble and operate your new SquareGlow alarm. Be sure to read **ALL OF THE INFORMATION** in this manual before using SquareGlow.

## Main Features



7 Led Colors



52 Ring Tones

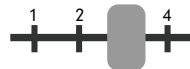

Volume Control

- IP 44 waterproof transmitter
- Operates up to 600 feet away
- Easy to add additional transmitters
- Low power consumption



# Unpack

You should find each of these items in your SquareGlow box:

1. Doorbell
2. Phone Signaler
3. 2 Receiver(Flasher)
4. 4 Screws
5. RJ11 Wire
6. 12v 23a battery

①



②



③



④



⑤



⑥



Remove all packing material, then inspect each item for any accidental damage that may have occurred during shipping.



## **What you should know before installation**

1. Doorbell's signal can be affected by metal, walls, concrete and interference from other electronics.
2. Determine the operating Range you want before installation.
3. Flasher only supports DC 5V 2A adapter or 3 AA batteries.

# Installation Methods

You can put it on the desk ,or hang it up as following method:

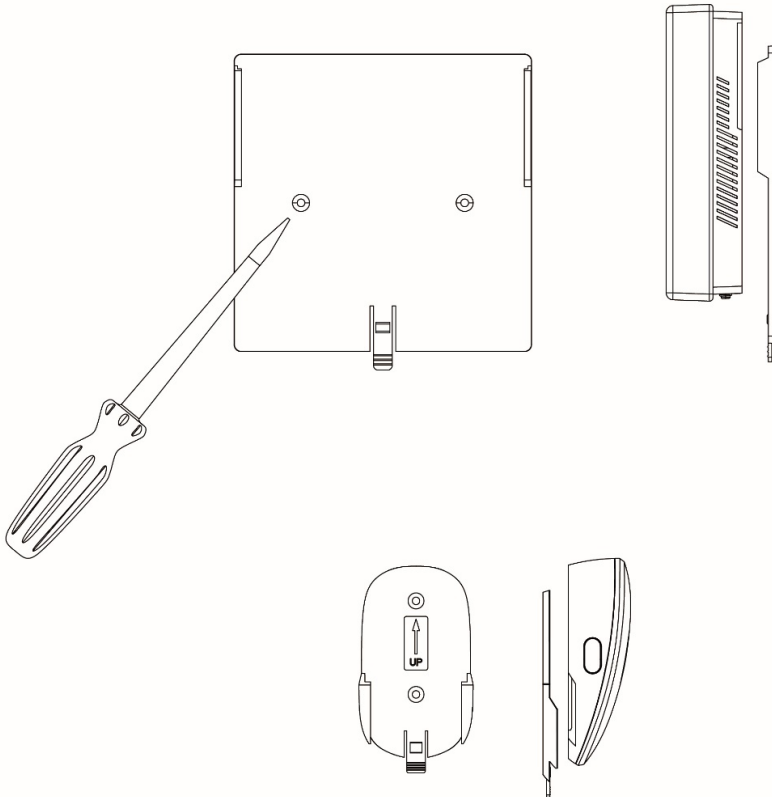

# Operating Instructions

Please read the following diagram of button functions before operation:

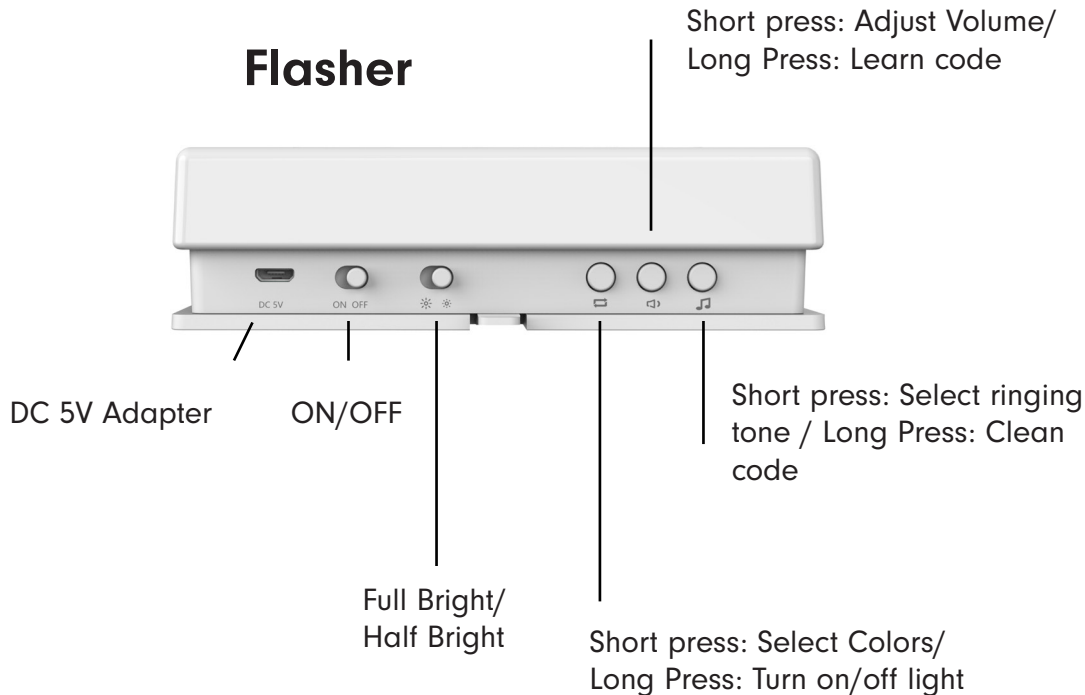

## Doorbell

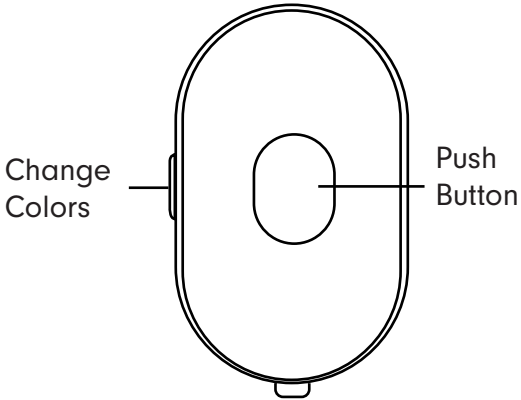

## Phone Signaler

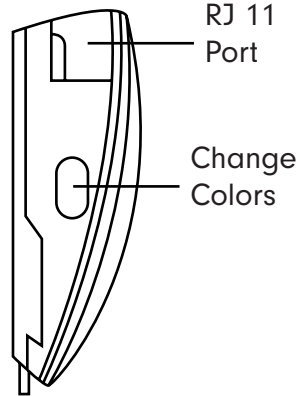

## Attention before operating

**Pull** out the insulating strips from the phone signaler.

**Insert** the RJ 11 wire for phone signaler.



**Equip** flashers with batteries or DC 5V adapter.

**Don't** use other adapters on flasher.





## Pairing Transmitters with Flashers

### Pairing LED colors:

1. Turn on flasher.
  2. Please ensure that the light on flasher is turned off after you turned off the power.
  3. Short press...  to select the LED color you want.
  4. Long press...  to launch pairing signal until flasher is flashing.
  5. Press the doorbell or phone signaler button quickly.
  6. Congratulations on your success.
- if it is not working, please try again.



## **Pairing ringing tones:**

1. Turn on the flasher.
  2. Please ensure that the light on flasher is turned off after you turn on the power.
  3. Short press...  to select the ring tone you want.
  4. Long press...  to launch pairing signal until the flasher is flashing.
  5. Press the doorbell or phone signaler button quickly.
  6. Congratulations on your success.
- if it is not working, please try again.

## **Attention after pairing:**

1. One flasher can pair with unlimited signalers.
2. One signaler can pair with countless flashers.
3. User can long press  to wipe all records, then begin pairing again.

# Warranty

For further information on warranty and claims, please visit **[www.squareglow.com](http://www.squareglow.com)**. For returns or repairs, please send your products in its original box to ensure a smooth return transition.



**SQUARE GLOW**