

USER'S MANUAL
AC POWERED
CARBON MONOXIDE ALARM
 120VAC ~, 60Hz, 0.09A

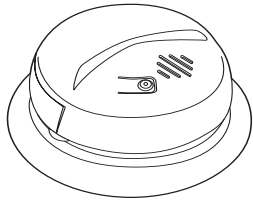

WITH BATTERY BACK-UP
Model CO5120BN

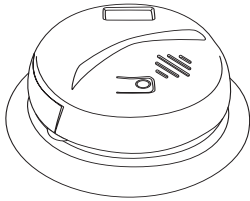

**WITH BATTERY BACK-UP
 AND DIGITAL DISPLAY**
Model CO5120PDBN

IMPORTANT! PLEASE READ CAREFULLY AND SAVE.

This user's manual contains important information about your CO Alarm's operation. If you are installing this CO Alarm for use by others, you must leave this manual—or a copy of it—with the end user.

M08-0002-003 Q 04/08 Printed in Mexico

LISTED TO
UL 2034
STANDARD

TABLE OF CONTENTS

Introduction1-2
 Basic Safety Information1
 How Your CO Alarm Works1-2
 Understanding the Light and Horn Patterns2
 Additional Features for Model CO512PDBN with Digital Display2
Installation2-3
 Where to Install CO Alarms2
 Where CO Alarms Should NOT Be Installed2
 Before You Begin Installation3
 How to Install Your CO Alarm3
Using the Locking Features4
 The Battery Compartment Lock4
 The Mounting Bracket Lock4
If Your CO Alarm Sounds5
 If the Alarm Sounds5
 Using the Silence Features5
 Latching Features5
Weekly Testing5
Regular Maintenance5
 Replacing the Battery5
What You Need To Know About CO5-6
 What is CO?5
 Symptoms of CO Poisoning6
 Finding the Source of CO After an Alarm6
 Potential Sources of CO in the Home6
 How Can I Protect My Family?6
Underwriters Laboratories, Inc. UL20346
General Limitations of CO Alarms7
Troubleshooting Guide7
Limited Warranty7

© 2008 BRK Brands, Inc., a Jarden Corporation company (NYSE: JAH)
 3901 Liberty Street Road, Aurora, IL 60504-8122
 All rights reserved.
 Consumer Affairs: (800) 323-9005 • www.firstalert.com

INTRODUCTION

Thank you for choosing BRK Brands, Inc. for your Carbon Monoxide Alarm needs. You have purchased a state-of-the-art Carbon Monoxide Alarm designed to provide you with early warning of carbon monoxide.

Key features include:

Most Accurate Carbon Monoxide Sensor*

Advanced electrochemical CO sensor technology.

Intelligent Sensing Technology is designed to help reduce unwanted or nuisance alarms.

Two Silence Features. Temporarily silence low battery chirp for up to eight hours before replacing low battery or silence an unwanted alarm for several minutes.

Two Latching Features. Alarm Latch: Easily identifies initiating alarm even after alarm condition has subsided. Low Battery Latch: Identifies which unit is in low battery condition.

Smart Interconnect interconnects with most First Alert® and BRK branded smoke, CO and heat alarms. When interconnected with alarming smoke alarms, unit will sound smoke horn pattern.

Dust Cover is included to keep the alarm clean during construction.

Easy Installation/Maintenance features include a large opening in the mounting bracket for easy access to wiring. A battery pull tab keeps the battery fresh until the home is occupied. A Side Load Battery Drawer allows for easy battery replacement without removing the alarm from the ceiling or wall.

BASIC SAFETY INFORMATION

IMPORTANT!

- Dangers, Warnings, and Cautions alert you to important operating instructions or to potentially hazardous situations. Pay special attention to these items.
- **THIS IS NOT A SMOKE ALARM!** This CO Alarm is designed to detect carbon monoxide from ANY source of combustion. It is NOT designed to detect smoke, fire, or any other gas.
- This CO Alarm is approved for use in single-family residences. It is NOT designed for marine or RV use.

⚠CAUTION!

- This CO Alarm will only indicate the presence of carbon monoxide gas at the sensor. Carbon monoxide gas may be present in other areas.

⚠WARNING!

- This unit does not work without power. If the AC power fails, the battery back-up will power the alarm for at least 7 days provided the 9V battery is fresh and correctly installed.
- The Silence Feature is for your convenience only and will not correct a CO problem. Always check your home for a potential problem after any alarm. Failure to do so can result in injury or death.
- This CO Alarm should receive continuous 120VAC, 60 Hz, pure sine wave electrical power. (The battery is meant for emergency back-up only). Do not use in an extension cord or outlet controlled by a dimmer or switch.
- NEVER ignore any alarm. See "If Your CO Alarm Sounds" for more information on how to respond to an alarm. Failure to respond can result in injury or death.
- Test this Carbon Monoxide Alarm once a week. If it ever fails to test correctly, have it replaced immediately! If the CO Alarm is not working properly, it cannot alert you to a problem.
- This product is intended for use in ordinary indoor locations of family living units. It is not designed to measure CO levels in compliance with Occupational Safety and Health Administration (OSHA) commercial or industrial standards. Individuals with medical conditions that may make them more sensitive to carbon monoxide may consider using warning devices which provide audible and visual signals for carbon monoxide concentrations under 30 ppm. For additional information on carbon monoxide and your medical condition contact your physician.

HOW YOUR CO ALARM WORKS

The Cover Of Your CO Alarm

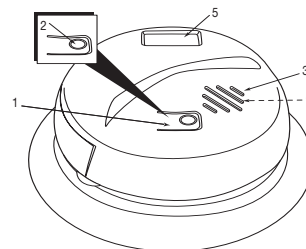

1. Test/Silence Button or Test/Silence/Scroll Button (CO5120PDBN only)
2. POWER/ALARM Light (RED)
3. Air Vents
4. (Behind the Cover) Alarm Horn: 85 dB audible alarm for test, alarm, and unit malfunction warning.
5. Digital Display (CO5120PDBN only)

UNDERSTANDING THE LIGHT AND HORN PATTERNS

Condition	LED (Red Light)	Horn
POWER UP	On continuously with AC Flash a minute with battery	Silent
DURING TESTING	LED flashes approximating the horn pattern.	Horn pattern: 4 beeps, pause, 4 beeps, pause
LOW OR MISSING BATTERY	Low battery Latch Pattern	Horn "chirps" once a minute
WARNING: When the AC power is Off, if the battery is dead or missing, the CO Alarm cannot work.		
ALARM CONDITION (Single CO Alarm (Stand alone Alarm))	LED flashes approximating the horn pattern.	Horn pattern: 4 beeps, pause, 4 beeps, pause, repeating
ALARM CONDITION (Interconnected Series of CO Alarms)	LED flashes rapidly on the unit(s) that triggered the alarm. LEDs on the other Alarms in the series will not flash	Horn pattern: 4 beeps, pause, repeating on all CO Alarms
ALARM SILENCE	LED flashes approximating the horn pattern.	Horn stays quiet for 4 minutes
LOW BATTERY SILENCE	LED flashing approximately every minute.	Horn is Silent for up to 8 hours.
ALARM LATCH	Audio Off and LED flashing 2 seconds On, 2 seconds Off after local alarm unless reset by Test/Silence button.	Horn is Silent
LOW BATTERY LATCH	LED flashing 4 seconds On, 2 seconds Off.	Horn is Silent
NOTE: Latching features are not active during battery backup mode operation.		
MALFUNCTION	LED flashes 3 times synchronized with 3 rapid chirps	Horn sounds 3 rapid chirps (chirp-chirp-chirp) every minute

ADDITIONAL FEATURES FOR MODEL CO5120PDBN WITH DIGITAL DISPLAY

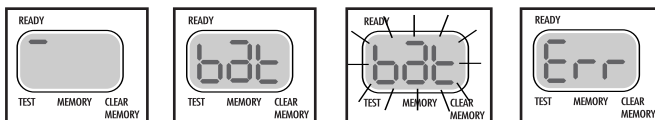

Alarm operating on AC power

Alarm operating on emergency battery back-up

Low / missing battery warning

"Err" Alarm is not operating properly

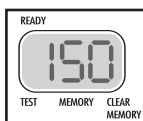

Levels of CO shown in ppm if present.

During Testing, the display flashes "30, 70, 150, 400" briefly. During initial power up display flashes "888" briefly.

USING THE PEAK CO MEMORY

The CO Memory Feature lets you check the highest level of CO recorded during an alarm.

To check CO Memory:

- Press and release the Test/Silence/Scroll button until the dash scrolls to "MEMORY".
- Press and hold Test/Silence/Scroll button to display Memory CO level.

To clear CO Memory:

- Press and release the Test/Silence/Scroll button until the dash scrolls to "CLEAR MEMORY."
- Press and hold the Test/Silence/Scroll button until the display shows "CLr."

NOTE: The highest CO level will be saved, even after a power interruption, until you clear it. DO NOT clear the CO Memory reading if you plan to call someone to investigate a CO problem! Clear the CO Memory reading only after the investigator has checked your home.

SMART INTERCONNECT FEATURE

This CO Alarm includes "Smart Interconnect" which enables the Alarm to be interconnected with other BRK Smoke and CO Alarms. When interconnected to Smoke Alarms that go into alarm, this CO Alarm will sound the smoke horn pattern.

INSTALLATION

WHERE TO INSTALL CO ALARMS

The National Fire Protection Association (NFPA) recommends that a CO Alarm should be centrally located outside of each separate sleeping area in the immediate vicinity of the bedrooms. For added protection, install additional CO Alarms in each separate bedroom, and on every level of your home.

If your bedroom hallway is longer than 40 feet (12 meters), install a CO Alarm at BOTH ends of the hallway.

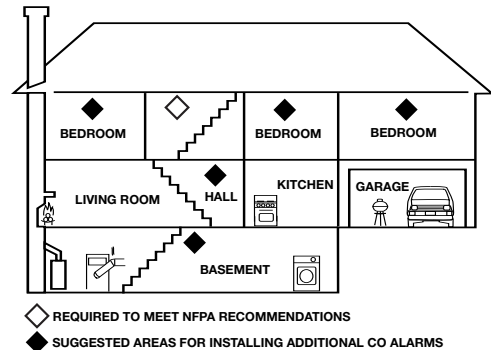

In a Single-level Home:

- Install at least one CO Alarm near or within each separate sleeping area.
- For added protection, install an additional CO Alarm at least 20 feet (6 meters), away from the furnace or fuel burning heat source.

In a Multi-level Home—(same as above plus):

- Install at least one CO Alarm near or within each separate sleeping area.
- For added protection, install at least one CO Alarm on each level of the home. If you have a basement, install that CO Alarm at the top of the basement stairs.
- For added protection, install an additional CO Alarm at least 20 feet (6 meters) away from the furnace or fuel burning heat source.

WHERE CO ALARMS SHOULD NOT BE INSTALLED

DO NOT locate this CO Alarm:

- In garages, kitchens, furnace rooms, or in any extremely dusty, dirty or greasy areas.
- Where combustion particles are produced. Combustion particles form when something burns. Areas to avoid include poorly ventilated kitchens, garages, and furnace rooms. Keep units at least 20 feet (6 meters) from the sources of combustion particles (stove, furnace, water heater, space heater) if possible. In areas where a 20-foot (6 meter) distance is not possible — in modular, mobile, or smaller homes, for example — it is recommended the CO Alarm be placed as far from these fuel-burning sources as possible. The placement recommendations are intended to keep these Alarms at a reasonable distance from a fuel-burning source, and thus reduce "unwanted" alarms. Unwanted alarms can occur if a CO Alarm is placed directly next to a fuel-burning source. Ventilate these areas as much as possible.
- Within 5 feet (1.5 meter) of any cooking appliance.
- In extremely humid areas. This Alarm should be at least 10 feet (3 meter) from a bath or shower, sauna, humidifier, vaporizer, dishwasher, laundry room, utility room or other source of high humidity.
- In areas where temperature is colder than 40° F (4° C) or hotter than 100° F (38° C). These areas include non-airconditioned crawl spaces, unfinished attics, uninsulated or poorly insulated ceilings, porches, and garages.
- In turbulent air, like near ceiling fans, heat vents, air conditioners, fresh air returns, or open windows. Blowing air may prevent CO from reaching the sensors.
- In direct sunlight.

⚠WARNING!

- This CO Alarm is designed for use inside a single-family home or apartment. It is not meant to be used in common lobbies, hallways, or basements of multi-family buildings unless working CO Alarms are also installed in each family living unit. CO Alarms in common areas may not be heard from inside individual family living units.
- This CO Alarm alone is not a suitable substitute for complete detection systems in places which house many people, like hotels or dormitories, unless a CO Alarm is also placed in each unit.
- DO NOT use this CO Alarm in warehouses, industrial or commercial buildings, special-purpose non-residential buildings, RVs, boats, or airplanes. This CO Alarm is specifically designed for residential use, and may not provide adequate protection in non-residential applications.

INSTALLATION, continued

BEFORE YOU BEGIN INSTALLATION

This unit is designed to be mounted on any standard wiring junction box up to a 4-inch (10 cm) size, on either the ceiling or wall. Read "Where to Install CO Alarms" and "Where Not To Install CO Alarms" before you begin installation.

⚠WARNING!

- This Alarm must have AC or battery power to operate. If the AC power fails, the battery back-up will power the Alarm for a short time if the 9V battery is fresh and correctly installed. If AC power fails, and the battery is dead or missing, the Alarm cannot operate.
- Make sure the alarm is not receiving excessive noisy power. Examples of noisy power could be major appliances on the same circuit, power from a generator or solar power, light dimmer on the same circuit or mounted near fluorescent lighting. Excessive noisy power may cause damage to your Alarm.

Find the pair of self-adhesive labels included with this CO Alarm.

- On each label write in the phone number of your emergency responder (like 911) and a qualified appliance technician.
- Place one label near the CO Alarm, and the other label in the "fresh air" location you plan to go if the alarm sounds.

NOTE: A qualified appliance technician is defined as "a person, firm, corporation, or company that either in person or through a representative, is engaged in and responsible for the installation, testing, servicing, or replacement of heating, ventilation, air conditioning (HVAC) equipment, combustion appliances and equipment, and/or gas fireplaces or other decorative combustion equipment."

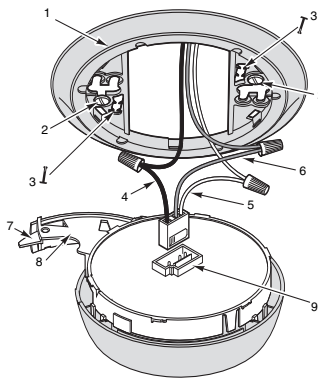

PARTS OF THIS CO ALARM

- | | |
|---|-------------------------------------|
| 1 | Mounting Bracket |
| 2 | Mounting Slot and Screw* |
| 3 | Locking Pins (break out of bracket) |
| 4 | Hot (Black) AC Wire |
| 5 | Neutral (White) AC Wire |
| 6 | Interconnect Wire (Orange) |
| 7 | Lever to Open Battery Compartment |
| 8 | Swing-Out Battery Compartment |
| 9 | Quick-Connect Power |

*Not Included

HOW TO INSTALL YOUR CO ALARM

Tools you will need: Standard Flathead screwdriver.

⚠DANGER!

ELECTRICAL SHOCK HAZARD. Turn off power to the area where you will install this unit at the circuit breaker or fuse box before beginning installation. Failure to turn off the power before installation may result in serious electrical shock, injury or death.

To install this unit:

1. Remove the mounting bracket from the base. Position the screw slots on the mounting bracket over the screws in the junction box. Tighten the screws.
2. Using wire nuts, connect the power connector to the AC power.

⚠WARNING!

Improper wiring of the power connector or the wiring leading to the power connector will cause damage to the Alarm and may lead to a non-functioning Alarm.

STAND ALONE ALARM ONLY:

- Connect the white wire on the power connector to the neutral wire in the junction box.
- Connect the black wire on the power connector to the hot wire in the junction box.
- Tuck the orange wire inside the junction box. **It is used for interconnect only.**

INTERCONNECTED ALARMS ONLY:

Strip off about 1/2" of the plastic coating on the orange interconnect wire on the power connector.

- Connect the white wire on the power connector to the neutral wire (usually white) in the junction box.
- Connect the black wire on the power connector to the hot wire (usually black) in the junction box.
- Connect the orange wire on the power connector to the interconnect wire in the junction box. Repeat for each unit you are interconnecting. Never connect the hot or neutral wires in the junction box to the orange interconnect wire.

3. Plug the power connector into the back of the CO Alarm.
4. Position the base of the Alarm over the mounting bracket and turn. The Alarm can be positioned over the bracket every 60°. Turn the unit clockwise (right) until the unit is in place.
5. Check all connections.

STAND ALONE ALARM ONLY:

- If you are only installing one unit, restore power to the junction box.

INTERCONNECTED ALARMS ONLY:

- If you are interconnecting multiple Alarms, repeat Step 1-5 for each Alarm in the series. When you are finished, restore power to the junction box.

⚠DANGER!

ELECTRICAL SHOCK HAZARD. Do not restore power until all Alarms are completely installed. Restoring power before installation is complete may result in serious electrical shock, injury or death.

6. Make sure the CO Alarm is receiving AC power. Under normal operation, the red indicator light will shine continuously. If the red power indicator light does not light, TURN OFF POWER TO THE JUNCTION BOX and recheck all connections. If all connections are correct and the red power indicator still does not light when you restore the power, the unit should be replaced immediately.

7. ACTIVATING THE BATTERY BACK-UP

IMPORTANT!

Activate the battery back-up by removing the "Pull to Activate Battery Back-Up" tab. You do not need to open the battery compartment and reposition the battery during installation. **DO NOT remove the battery activation tab until AC power is turned on to conserve battery power.**

8. **Test the CO Alarm.** Press and hold the test button on the cover until the alarm sounds: 4 beeps, pause, 4 beeps, pause. In a series of interconnected Alarms, you must test each Alarm separately by pressing and holding the test button. Make sure all units alarm when each one is tested.

IMPORTANT!

If any unit in the series does not alarm during testing, TURN OFF POWER and recheck connections. If it does not alarm when you restore power, replace it immediately.

SPECIAL REQUIREMENTS FOR INTERCONNECTED CO ALARMS

⚠WARNING!

- Failure to meet any of the above requirements could damage the units and cause them to malfunction, removing your protection.
- AC and AC/DC CO Alarms can be interconnected. Under AC power, all units will alarm when one senses CO. When power is interrupted, only the AC/DC units in the series will continue to send and receive signals. AC powered CO Alarms will not operate.

Interconnected units can provide earlier warning of a CO problem than stand-alone units, especially if the problem starts in a remote area of the dwelling. If any unit in the series senses CO, all CO and Smart Interconnect units will alarm. To determine which CO Alarm initiated an alarm, refer to the table.

On Initiating CO Alarm	Red LED Flashes the alarm pattern
On All Other CO Alarms	Red LED Does Not Flash the alarm pattern

IMPORTANT!

Interconnect units within a single family residence only. Otherwise all households will experience unwanted alarms when you test any unit in the series. Interconnected units will only work if they are wired to compatible units and all requirements are met. This unit is designed to be compatible with:

BRK Electronics® and **First Alert®** Models 7010, 7010B, 7020B, SC7010B, SA520B, 9120, 9120B, SC9120B, 100S, SL177, SC7010BV, CO5120BN, CO5120PDBN, HD6135F, HD6135FB.

Interconnected units must meet ALL of the following requirements:

- A maximum of 18 compatible Smoke, Heat or CO Alarms may be interconnected. No more than 12 of the 18 can be Smoke Alarms per NFPA 72.
- The same fuse or circuit breaker must power all interconnected units.
- The total length of wire interconnecting the units should be less than 1000 feet. This type of wire is commonly available at Hardware and Electrical Supply stores.
- All wiring must conform to all local electrical codes and Articles 210 and 300.3 (B) of the National Electrical Code. Refer to your local building code for further connection requirements.

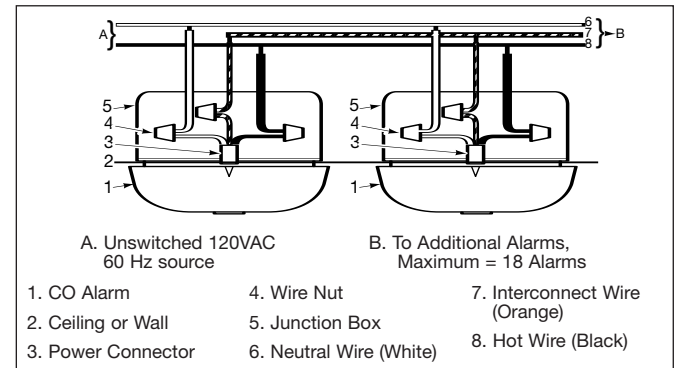

USING THE LOCKING FEATURES

The optional locking features are designed to prevent unauthorized removal of the battery or alarm. It is not necessary to activate the locks in single-family households where unauthorized battery or alarm removal is not a concern.

These CO Alarms have two separate locking features: one locks the battery compartment, and the other locks the CO Alarm to the mounting bracket. You can choose to use either feature independently, or use them both.

Tools you will need: • Needle-nose pliers • Standard Flathead screwdriver.

Both locking features use locking pins, molded into the mounting bracket. Using needle nose pliers remove one or both pins, depending on which locking features you use.

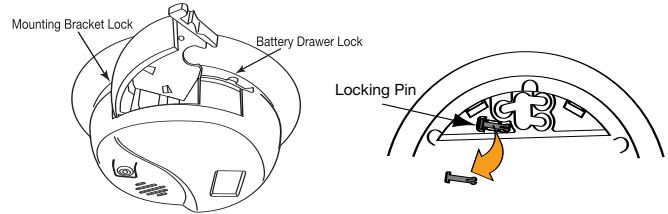

THE BATTERY COMPARTMENT LOCK TO LOCK THE BATTERY COMPARTMENT:

IMPORTANT!

Do not lock the battery compartment until you have activated the battery and tested the battery back-up.

1. Activate the battery back-up by removing the "Pull to Activate Battery Back-Up" tab. Push and hold the test button on the CO Alarm's cover until you hear an acknowledge chirp and the alarm sounds: 4 beeps, pause, 4 beeps, pause.

If the unit does not alarm during testing, DO NOT lock the battery compartment! Install a new battery and test again. If it still does not alarm, replace the CO Alarm immediately.

2. Using needle-nose pliers, detach one locking pin from the mounting bracket.
3. Push the locking pin through the black dot on the label on the back of the CO Alarm.

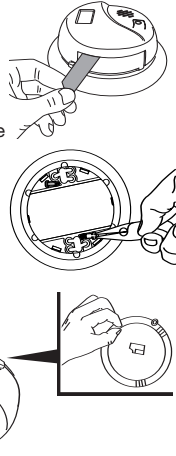

TO UNLOCK THE BATTERY COMPARTMENT:

IMPORTANT!

Once the CO Alarm is installed, you must disconnect it from the AC power before unlocking the battery compartment.

⚠ DANGER!

ELECTRICAL SHOCK HAZARD. Turn off the power to the area where the CO Alarm is installed before removing it from the mounting bracket. Failure to turn off the power first may result in serious electrical shock, injury or death.

1. Remove the CO Alarm from the mounting bracket. If the unit is locked to the bracket, see the section "To Deactivate the Locking Feature."
2. Disconnect the power connector by gently prying it away from the back of the CO Alarm.
3. Insert a flathead screwdriver under the head of the locking pin, and gently pry it out of the battery compartment lock. (If you plan to relock the battery compartment, save the locking pin.)
4. To relock the battery compartment, close the battery door and reinsert the locking pin in the lock.
5. Reconnect the power connector to the back of the CO Alarm, reattach the CO Alarm to the mounting bracket, and restore the power.

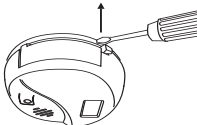

IMPORTANT!

When replacing the battery, always test the CO Alarm before relocking the battery compartment.

THE MOUNTING BRACKET LOCK

Tools you will need:

- Needle-nose pliers
- Standard Flathead screwdriver

TO ACTIVATE THE BRACKET LOCK:

1. Using needle-nose pliers, detach one locking pin from the mounting bracket.
2. Insert the locking pin into the lock located on the pivoting hinge of the battery door.
3. When you attach the CO Alarm to the mounting bracket, the locking pin's head will fit into a notch on the bracket.

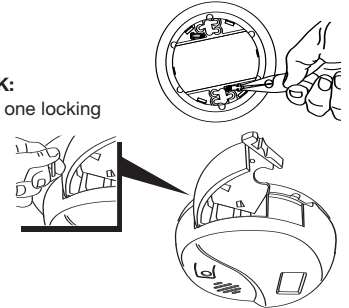

TO DEACTIVATE THE BRACKET LOCK:

⚠ DANGER!

ELECTRICAL SHOCK HAZARD. Turn off the power to the area where the CO Alarm is installed before removing it from the mounting bracket. Failure to turn off the power first may result in serious electrical shock, injury or death.

⚠ WARNING!

Always discharge the branch circuit before servicing an AC or AC/DC CO Alarm. First, turn off the AC power at the circuit breaker or fuse box. Next, remove the battery from Alarms with battery back-up. Finally, press and hold the test button.

1. Insert a flathead screwdriver between the mounting bracket pin and the mounting bracket.
2. Pry the CO Alarm away from the bracket by turning both the screwdriver and the CO Alarm counterclockwise (left) at the same time.

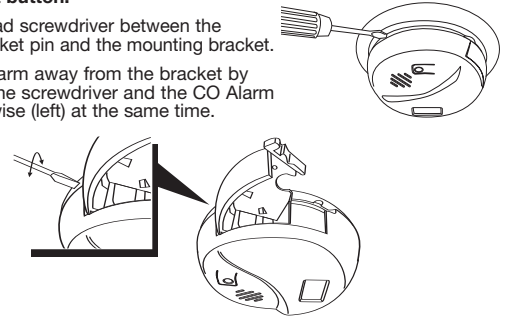

TO PERMANENTLY REMOVE THE BRACKET LOCK:

Insert the flathead screwdriver between the locking pin and the lock, and pry the pin out of the lock.

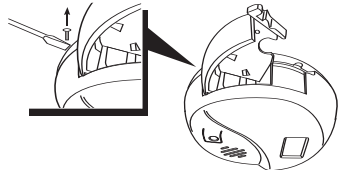

IF YOUR CO ALARM SOUNDS

⚠WARNING!

Actuation of your CO Alarm indicates the presence of carbon monoxide (CO) which can kill you. When your CO Alarm sounds, you must not ignore it!

IF THE ALARM SOUNDS:

1. Operate the Test/Silence button to silence the alarm.
2. Call your emergency services, fire department or 911. Write down the number of your local emergency service here:
3. Immediately move to fresh air—outdoors or by an open door or window. Do a head count to check that all persons are accounted for. Do not re-enter the premises, or move away from the open door or window until the emergency services responder has arrived, the premises have been aired out, and your CO Alarm remains in its normal condition.
4. After following steps 1-3, if your CO Alarm reactivates within a 24-hour period, repeat steps 1-3 and call a qualified appliance technician to investigate for sources of CO from fuel-burning equipment and appliances, and inspect for proper operation of this equipment. If problems are identified during this inspection have the equipment serviced immediately. Note any combustion equipment not inspected by the technician, and consult the manufacturers' instructions, or contact the manufacturers directly, for more information about CO safety and this equipment. Make sure that motor vehicles are not, and have not, been operating in an attached garage or adjacent to the residence. Write down the number of a qualified appliance technician here:

⚠WARNING!

Alarms have various limitations. See "General Limitations of CO Alarms" for details.

USING THE SILENCE FEATURES

⚠WARNING!

NEVER disconnect the power to your CO Alarm to silence the horn—use the silence feature. Disconnecting the CO Alarm removes your protection! See previous page for details on responding to an alarm.

The Silence Feature is intended to temporarily silence your CO Alarm's alarm horn while you correct the problem—it will not correct a CO problem. While the Alarm is silenced, it will continue to monitor the air for CO. When CO reaches alarm level, the unit will sound—repeating horn pattern: 4 beeps, a pause, 4 beeps, etc. Press and hold the Test/Silence button until the horn is silent. The Silence cycle will last approximately 4 minutes.

To silence an interconnected series of Alarms, you must press the Test/Silence button on the initiating alarm (the unit with the flashing red light). If you press the Test/Silence on any other Alarm, it will only silence that unit, not the whole interconnected series.

NOTE: After the 4-minute silence cycle, the CO Alarm re-evaluates present CO levels and responds accordingly. If CO levels remain potentially dangerous—or start rising higher—the horn will start sounding again.

While the CO Alarm is silenced:

If the CO Alarm...is silent for only 4 minutes, then starts sounding loudly—4 beeps, then a pause, 4 beeps, then a pause. Red light (LED) continues flashing... This means...CO levels are still potentially dangerous.

If the CO Alarm...remains silent...

This means...unit has returned to normal operation.

SILENCING THE LOW BATTERY WARNING

This silence feature can temporarily quiet the low battery warning "chirp" for up to 8 hours if AC power is present. Press the Test/Silence button on the alarm cover. Once the low battery warning "chirp" silence feature is activated, the unit continues to flash the red light once a minute for 8 hours. After 8 hours, the low battery "chirp" will resume. **Replace the battery as soon as possible**, to maintain protection in the event of a power outage.

LATCHING FEATURES

Alarm Latch is activated after an Alarm is exposed to alarm levels of carbon monoxide. This feature will only work with AC power. After CO levels drop below alarm levels, the Red LED will begin to flash On for 2 seconds and Off for 2 seconds. It will continue to flash or "latch" until you clear it by testing the Alarm.

This feature helps emergency responders, investigators, or service technicians identify which unit(s) in your home were exposed to alarm levels of carbon monoxide. This can help investigators pinpoint the source of CO.

Interconnected Alarms. Latching Alarm Indicator shows which Alarm(s) in the series were exposed to alarm levels of carbon monoxide.

The Latching Alarm Indicator stays ON until you clear it, so it can alert you to a CO Alarm that occurred while you were away from home, even though CO present in the air has dropped below alarm levels.

Low Battery Latch is activated when the Alarm is in the "low battery condition". When this occurs, the red LED flashes 4 seconds On/2 seconds Off. This feature is designed to help you identify which Alarm needs to have the battery replaced. Although, the Alarm will sound the low battery chirp approximately once every minute, sometimes during the initial stages of "low battery", the Alarm will chirp in greater intervals than one minute, sometimes up to several hours, until the battery reaches a steady low battery level. This innovative feature eliminates the frustration of waiting for and/or identifying which unit is chirping.

WEEKLY TESTING

Push and hold the Test/Silence button until you hear an acknowledge chirp and a loud alarm sounds — 4 beeps, pause, 4 beeps. This sequence should last for 10 seconds. If the Alarm ever fails to test properly, replace it immediately. If the Alarm is not working properly, refer to "Limited Warranty".

⚠WARNING!

- **If the Alarm ever fails to test properly, replace it immediately. Products under warranty may be returned to the manufacturer for replacement. See "Limited Warranty" at the end of this manual.**
- **DO NOT stand close to the Alarm when the horn is sounding. Exposure at close range may be harmful to your hearing. When testing, step away when horn starts sounding.**
- **NEVER use vehicle exhaust! Exhaust may cause permanent damage and voids your warranty.**

REGULAR MAINTENANCE

To keep the CO Alarm working properly:

- Test it every week as described in "Weekly Testing."
- Vacuum the CO Alarm cover at least once a month, using the soft brush attachment. Never use water, cleaners, or solvents, since they may damage the unit. Test the Alarm again after vacuuming.
- Replace the battery immediately when you see/hear the "Low Battery Warning".

The Low (or Missing) Battery Warning (CO5120PDBN):

The horn will "chirp" once a minute and the word "bat" will flash on and off on the display.

REPLACING THE BATTERY

Choosing a replacement battery: This unit requires one standard 9V alkaline battery. The following alkaline batteries are acceptable as replacements: Duracell #MN1604 or MX1604; Eveready "Energizer" 522. These replacement batteries are commonly available at local retail stores.

IMPORTANT!

Use only the alkaline or lithium replacement batteries listed. The unit may not operate properly with other batteries. Never use rechargeable batteries since they may not provide a constant charge.

⚠CAUTION!

DO NOT spray cleaning chemicals or insect sprays directly on or near the CO Alarm. DO NOT paint over the CO Alarm. Doing so may cause permanent damage.

IMPORTANT!

- Household cleaners, aerosol chemicals and other contaminants can affect the sensor. When using any of these materials near the CO Alarm, make sure the room is well ventilated.
- If your home is being fumigated, unplug the unit temporarily and put it where it will not be exposed to chemicals or fumes. When fumigation is complete and all traces of fumes clear, plug the unit back in and retest it.

WHAT YOU NEED TO KNOW ABOUT CO

WHAT IS CO?

CO is an invisible, odorless, tasteless gas produced when fossil fuels do not burn completely, or are exposed to heat (usually fire). Electrical appliances typically do not produce CO.

These fuels include: Wood, coal, charcoal, oil, natural gas, gasoline, kerosene, and propane.

Common appliances are often sources of CO. If they are not properly maintained, are improperly ventilated, or malfunction, CO levels can rise quickly. CO is a real danger now that homes are more energy efficient. "Air-tight" homes with added insulation, sealed windows, and other weatherproofing can "trap" CO inside.

SYMPTOMS OF CO POISONING

These symptoms are related to CO POISONING and should be discussed with ALL household members.

Mild Exposure: Slight headache, nausea, vomiting, fatigue ("flu-like" symptoms).

Medium Exposure: Throbbing headache, drowsiness, confusion, fast heart rate.

Extreme Exposure: Convulsions, unconsciousness, heart and lung failure. Exposure to Carbon Monoxide can cause brain damage, death.

IMPORTANT!

This CO Alarm measures exposure to CO over time. It alarms if CO levels are extremely high in a short period of time, or if CO levels reach a certain minimum over a long period of time. The CO Alarm generally sounds an alarm before the onset of symptoms in average, healthy adults.

Why is this important? Because you need to be warned of a potential CO problem while you can still react in time. In many reported cases of CO exposure, victims may be aware that they are not feeling well, but become disoriented and can no longer react well enough to exit the building or get help. Also, young children and pets may be the first affected. The average healthy adult might not feel any symptoms when the CO Alarm sounds. However, people with cardiac or respiratory problems, infants, unborn babies, pregnant mothers, or elderly people can be more quickly and severely affected by CO. If you experience even mild symptoms of CO poisoning, consult your doctor immediately!

FINDING THE SOURCE OF CO AFTER AN ALARM

Carbon monoxide is an odorless, invisible gas, which often makes it difficult to locate the source of CO after an alarm. These are a few of the factors that can make it difficult to locate sources of CO:

- House well ventilated before the investigator arrives.
- Problem caused by "backdrafting."
- Transient CO problem caused by special circumstances.

Because CO may dissipate by the time an investigator arrives, it may be difficult to locate the source of CO. **BRK Brands, Inc. shall not be obligated to pay for any carbon monoxide investigation or service call.**

POTENTIAL SOURCES OF CO IN THE HOME

Fuel-burning appliances like: portable heater, gas or wood burning fireplace, gas kitchen range or cooktop, gas clothes dryer.

Damaged or insufficient venting: corroded or disconnected water heater vent pipe, leaking chimney pipe or flue, or cracked heat exchanger, blocked or clogged chimney opening.

Improper use of appliance/device: operating a barbecue grill or vehicle in an enclosed area (like a garage or screened porch).

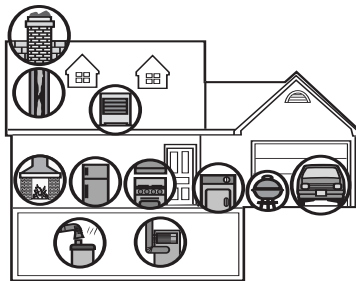

Transient CO Problems: "transient" or on-again-off-again CO problems can be caused by outdoor conditions and other special circumstances.

The following conditions can result in transient CO situations:

1. Excessive spillage or reverse venting of fuel appliances caused by outdoor conditions such as:
 - Wind direction and/or velocity, including high, gusty winds. Heavy air in the vent pipes (cold/humid air with extended periods between cycles).
 - Negative pressure differential resulting from the use of exhaust fans.
 - Several appliances running at the same time competing for limited fresh air.
 - Vent pipe connections vibrating loose from clothes dryers, furnaces, or water heaters.
 - Obstructions in or unconventional vent pipe designs which can amplify the above situations.
2. Extended operation of unvented fuel burning devices (range, oven, fireplace).
3. Temperature inversions, which can trap exhaust close to the ground.
4. Car idling in an open or closed attached garage, or near a home.

These conditions are dangerous because they can trap exhaust in your home. Since these conditions can come and go, they are also hard to recreate during a CO investigation.

HOW CAN I PROTECT MY FAMILY?

A CO Alarm is an excellent means of protection. It monitors the air and sounds a loud alarm before carbon monoxide levels become threatening for average, healthy adults.

A CO Alarm is not a substitute for proper maintenance of home appliances.

To help prevent CO problems and reduce the risk of CO poisoning:

- Clean chimneys and flues yearly. Keep them free of debris, leaves, and nests for proper air flow. Also, have a professional check for rust and corrosion, cracks, or separations. These conditions can prevent proper air movement and cause backdrafting. Never "cap" or cover a chimney in any way that would block air flow.
- Test and maintain all fuel-burning equipment annually. Many local gas or oil companies and HVAC companies offer appliance inspections for a nominal fee.
- Make regular visual inspections of all fuel-burning appliances. Check appliances for excessive rust and scaling. Also check the flame on the burner and pilot lights. The flame should be blue. A yellow flame means fuel is not being burned completely and CO may be present. Keep the blower door on the furnace closed. Use vents or fans when they are available on all fuel-burning appliances. Make sure appliances are vented to the outside. Do not use grills or barbecue indoors, or in garages or on screen porches.
- Check for exhaust backflow from CO sources. Check the draft hood on an operating furnace for a backdraft. Look for cracks on furnace heat exchangers.
- Check the house or garage on the other side of shared wall.
- Keep windows and doors open slightly. If you suspect that CO is escaping into your home, open a window or a door. Opening windows and doors can significantly decrease CO levels.

UNDERWRITERS LABORATORIES INC. UL2034

WHAT LEVELS OF CO CAUSE AN ALARM?

Underwriters Laboratories Inc. Standard UL2034 requires residential CO Alarms to sound when exposed to levels of CO and exposure times as described below. They are measured in parts per million (ppm) of CO over time (in minutes).

UL2034 Required Alarm Points*:

- If the Alarm is exposed to 400 ppm of CO, IT MUST ALARM BETWEEN 4 and 15 MINUTES
- If the Alarm is exposed to 150 ppm of CO, IT MUST ALARM BETWEEN 10 and 50 MINUTES.
- If the Alarm is exposed to 70 ppm of CO, IT MUST ALARM BETWEEN 60 and 240 MINUTES.

* Approximately 10% COHb exposure at levels of 10% to 95% Relative Humidity (RH).

The unit is designed not to alarm when exposed to a constant level of 30 ppm for 30 days.

IMPORTANT!

CO Alarms are designed to alarm before there is an immediate life threat. Since you cannot see or smell CO, never assume it's not present.

- An exposure to 100 ppm of CO for 20 minutes may not affect average, healthy adults, but after 4 hours the same level may cause headaches.
- An exposure to 400 ppm of CO may cause headaches in average, healthy adults after 35 minutes, but can cause death after 2 hours.

Standards: Underwriters Laboratories Inc. Single and Multiple Station carbon monoxide alarms UL2034.

According to Underwriters Laboratories Inc. UL2034, Section 1-1.2: "Carbon monoxide alarms covered by these requirements are intended to respond to the presence of carbon monoxide from sources such as, but not limited to, exhaust from internal-combustion engines, abnormal operation of fuel-fired appliances, and fireplaces. CO Alarms are intended to alarm at carbon monoxide levels below those that could cause a loss of ability to react to the dangers of Carbon Monoxide exposure." This CO Alarm monitors the air at the Alarm, and is designed to alarm before CO levels become life threatening. This allows you precious time to leave the house and correct the problem. This is only possible if Alarms are located, installed, and maintained as described in this manual.

Gas Detection at Typical Temperature and Humidity Ranges: The CO Alarm is not formulated to detect CO levels below 30 ppm typically. UL tested for false alarm resistance to Methane (500 ppm), Butane (300 ppm), Heptane (500 ppm), Ethyl Acetate (200 ppm), Isopropyl Alcohol (200 ppm) and Carbon Dioxide (5000 ppm). Values measure gas and vapor concentrations in parts per million.

Audible Alarm: 85 dB minimum at 10 feet (3 meters).

GENERAL LIMITATIONS OF CO ALARMS

This CO Alarm is intended for residential use. It is not intended for use in industrial applications where Occupational Safety and Health Administration (OSHA) requirements for carbon monoxide detectors must be met.

CO alarms may not waken all individuals. If children or others do not readily waken to the sound of the CO alarm, or if there are infants or family members with mobility limitations, make sure that someone is assigned to assist them in the event of an emergency.

CO Alarms will not work without power. This CO Alarm requires a continuous supply of AC power, and a fresh, correctly installed 9V battery to power the battery back-up. The battery back-up is for emergency use only!

CO Alarms for Solar or Wind Energy users and battery backup power systems: AC powered CO Alarms should only be operated with true or pure sine wave inverters. Operating this CO Alarm with most battery-powered UPS (uninterruptible power supply) products or square wave or "quasi sine wave" inverters **will damage the Alarm.** If you are not sure about your inverter or UPS type, please consult with the manufacturer to verify.

This CO Alarm will not sense carbon monoxide that does not reach the sensor. This CO Alarm will only sense CO at the sensor. CO may be present in other areas. Doors or other obstructions may affect the rate at which CO reaches the CO Alarm. For this reason, if bedroom doors are usually closed at night, we recommend you install a CO Alarm in each bedroom and in the hallway between them.

CO Alarms may not sense CO on another level of the home. For example, a CO Alarm on the second level, near the bedrooms, may not sense CO in the basement. For this reason, one CO Alarm may not give adequate warning. Complete coverage is recommended. Place CO Alarms on each level of the home.

CO Alarms may not be heard. The Alarm horn loudness meets or exceeds current UL standards of 85 dB at 10 feet (3 meters). However, if the CO Alarm is installed outside the bedroom, it may not wake up a sound sleeper or one who has recently used drugs or has been drinking alcoholic beverages. This is especially true if the door is closed or only partly open. Even persons who are awake may not hear the alarm horn if the sound is blocked by distance or closed doors. Noise from traffic, stereo, radio, television, air conditioner, or other appliances may also prevent alert persons from hearing the alarm horn. This CO Alarm is not intended for people who are hearing impaired.

CO Alarms are not a substitute for a smoke alarm. Although fire is a source of carbon monoxide, this CO Alarm does not sense smoke or fire. This CO Alarm senses CO that may be escaping unnoticed from malfunctioning furnaces, appliances, or other sources. Early warning of fire requires the installation of smoke alarms.

CO Alarms are not a substitute for life insurance. Though these CO Alarms warn against increasing CO levels, BRK Brands, Inc. does not warrant or imply in any way that they will protect lives from CO poisoning. Homeowners and renters must still insure their lives.

CO Alarms have a limited life. Although the CO Alarm and all of its parts have passed many stringent tests and are designed to be as reliable as possible, any of these parts could fail at any time. Therefore, you must test your CO Alarm weekly.

CO Alarms are not foolproof. Like all other electronic devices, CO Alarms have limitations. They can only detect CO that reaches their sensors. They may not give early warning to rising CO levels if the CO is coming from a remote part of the home, away from the CO Alarm.

TROUBLESHOOTING GUIDE

▲ DANGER!

ELECTRICAL SHOCK HAZARD. Turn off the power to the area where the CO Alarm is installed **BEFORE** removing it from the mounting bracket or checking any electrical connections! Failure to turn off the power first may result in serious electrical shock, injury or death.

The following guide can help you identify a potential problem with the installation or operation of your CO Alarm. **NOTE: It is not meant to be an all-inclusive list of all CO Alarm conditions.** If you are experiencing a condition not covered in the next several pages, please contact Consumer Affairs.

Problem...	If the Alarm..	You should...
Red light is OFF. Unit will not alarm when you press the Test/Silence button.	Unit may not be receiving any power.	Check the AC power supply. Make sure the power connector is securely attached to the Alarm. Make sure a fresh 9V battery is installed to power the battery back-up.
Red light flashes once a minute (horn is silent). (CO5120PDBN display reads "bat").	Alarm is not receiving AC power.	Unit is operating on DC battery back-up. Check the AC power supply.
The red light flashes and the horn "chirps" once a minute. (CO5120PDBN display flashes "bat").	Low battery warning.	Replace the 9V battery in the battery back-up. Disconnect AC power before changing the battery.
Once a minute, the alarm sounds 3 quick "chirps", and the red light flashes quickly three times. (CO5120PDBN display reads "Err").	MALFUNCTION SIGNAL. Based on its Self Test diagnostics, the unit has detected a malfunction. The unit needs to be replaced.	Make sure a fresh 9V battery is installed. If unit still isn't functioning— REPLACE IT. Units under warranty should be returned to manufacturer for replacement. See "Limited Warranty" for details.
CO Alarm goes back into alarm 4 minutes after you press the Test/Silence button.	CO levels are still potentially dangerous.	Refer to "If Your CO Alarm Sounds" for details on how to respond to an alarm. If anyone is feeling ill, EVACUATE your home immediately and call 911.
CO Alarm sounds frequently even though no high levels of CO are revealed in an investigation.	The CO Alarm may be improperly located. Refer to "Where to Install CO Alarms."	Relocate your Alarm. If frequent alarms continue, have home rechecked for potential CO problems. You may be experiencing an intermittent CO problem.

LIMITED WARRANTY

BRK Brands, Inc., ("BRK") the maker of First Alert® brand products warrants that for a period of five years from the date of purchase, this product will be free from defects in material and workmanship. BRK, at its option, will repair or replace this product or any component of the product found to be defective during the warranty period. Replacement will be made with a new or remanufactured product or component. If the product is no longer available, replacement may be made with a similar product of equal or greater value. This is your exclusive warranty. This warranty is valid for the original retail purchaser from the date of initial retail purchase and is not transferable. Keep the original sales receipt. Proof of purchase is required to obtain warranty performance. BRK dealers, service centers, or retail stores selling BRK products do not have the right to alter, modify or any way change the terms and conditions of this warranty.

This warranty does not cover normal wear of parts or damage resulting from any of the following: negligent use or misuse of the product, use on improper voltage or current, use contrary to the operating instructions, disassembly, repair or alteration by anyone other than BRK or an authorized service center. Further, the warranty does not cover Acts of God, such as fire, flood, hurricanes and tornadoes or any batteries that are included with this unit.

BRK shall not be liable for any incidental or consequential damages caused by the breach of any express or implied warranty. Except to the extent prohibited by applicable law, any implied warranty of merchantability or fitness for a particular purpose is limited in duration to the duration of the above warranty. Some states, provinces or jurisdictions do not allow the exclusion or limitation of incidental or consequential damages or limitations on how long an implied warranty lasts, so the above limitations or exclusion may not apply to you. This warranty gives you specific legal rights, and you may also have other rights that vary from state to state or province to province.

How to Obtain Warranty Service

Service: If service is required, do not return the product to your retailer. In order to obtain warranty service, contact the Consumer Affairs Division at 1-800-323-9005, 7:30 AM - 5:00 PM Central Standard Time, Monday through Friday. To assist us in serving you, please have the model number and date of purchase available when calling. **For Warranty Service return to:** BRK Brands, Inc., 25 Spur Drive, El Paso, TX 79906

Battery: BRK Brands, Inc. make no warranty, express or implied, written or oral, including that of merchantability or fitness for any particular purpose with respect to battery.

For your records, please record:

Date Purchased: _____ Where Purchased: _____

Date Installed: _____ / _____ Month/Year

Replacement date is five years after installation:

_____ / _____ Month/Year

NOTE: End of Life Signal — Once the unit reaches the end of its lifecycle, the MALFUNCTION SIGNAL will sound once a minute to indicate the need to immediately replace the Alarm.