

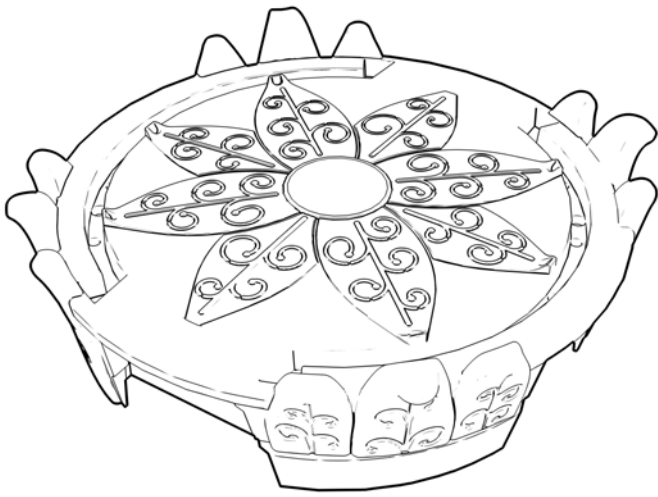

Happy Hollow

Inventory List and Install Guide



HH01
Quantity: 1

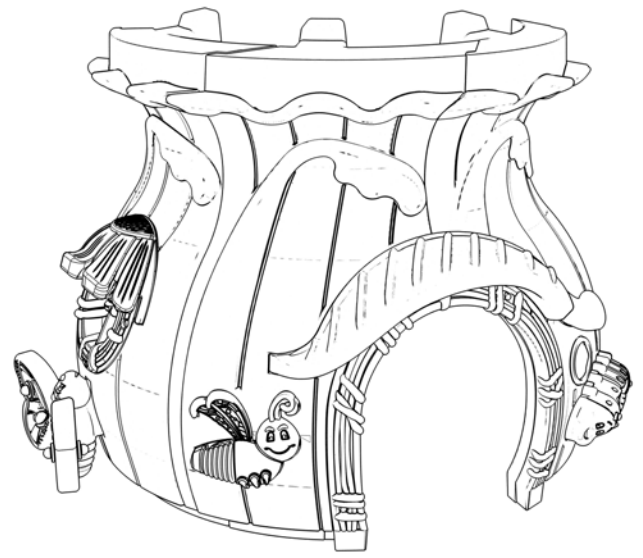

HH02
Quantity: 1

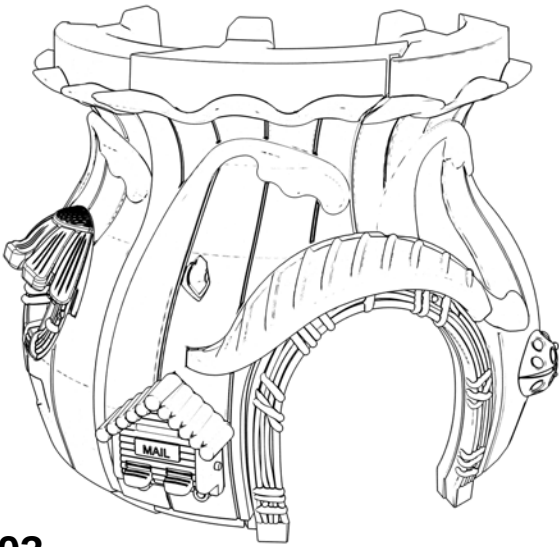

HH03
Quantity: 1

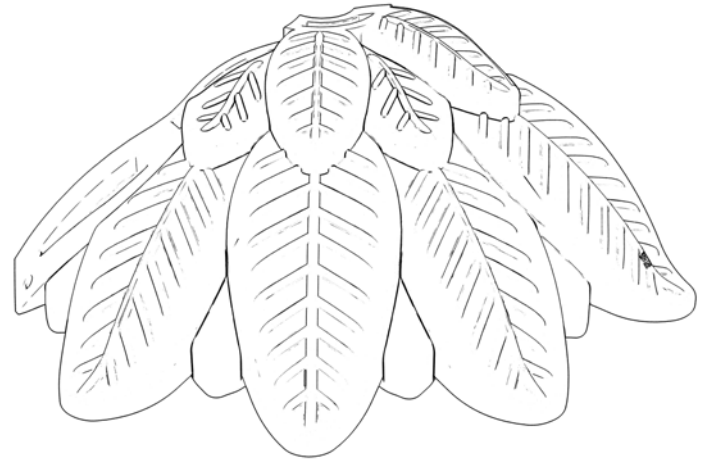

HH04
Quantity: 3

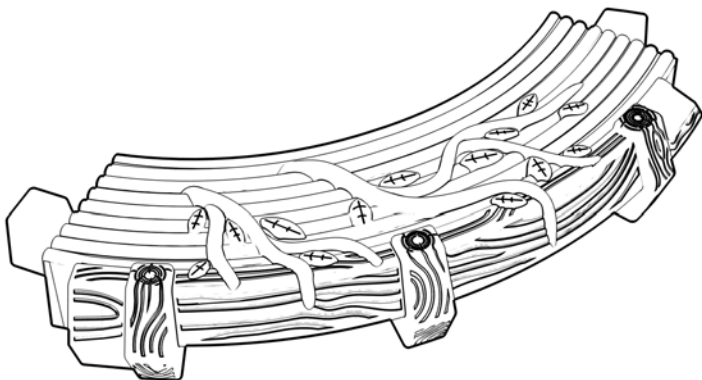

HH05
Quantity: 1



HH06
Quantity: 1

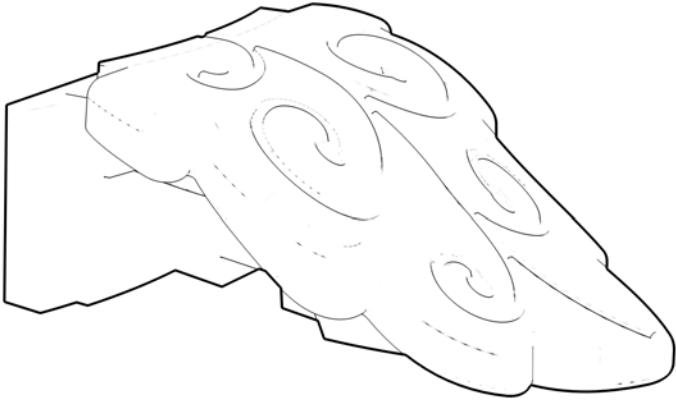

HH07
Quantity: 1

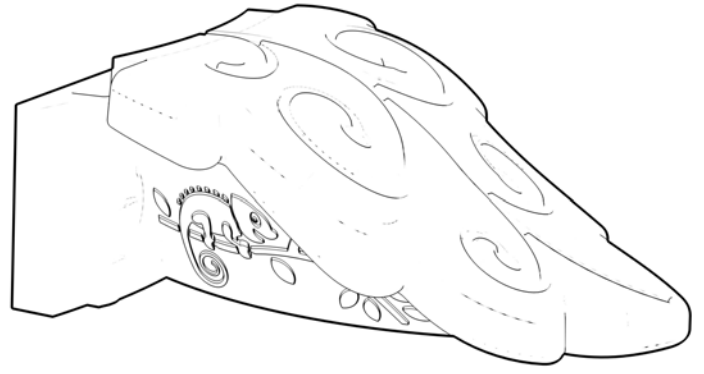

HH08
Quantity: 1

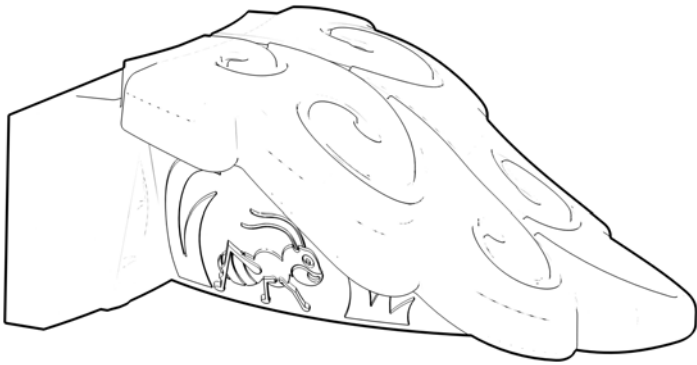

HH09
Quantity: 1

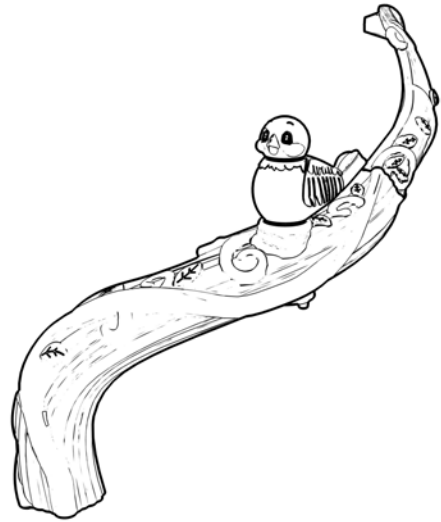

HH10
Quantity: 1

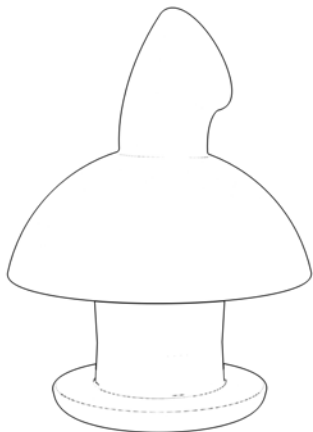

HH11
Quantity: 1

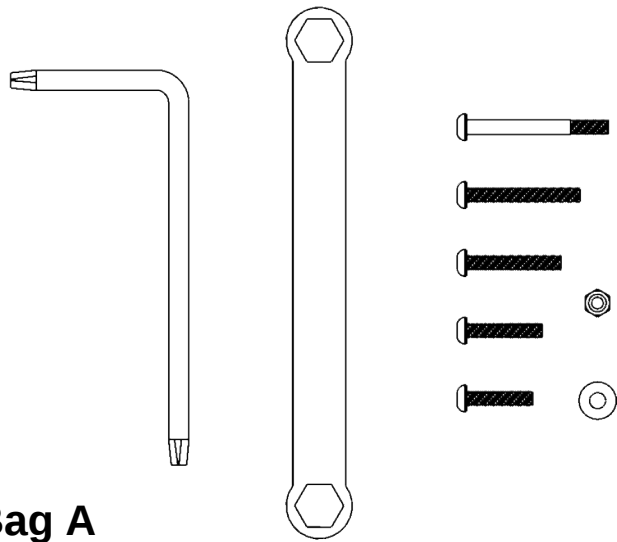

Bag A
Tools and Extra Hardware

* We recommend that you DO NOT use power tools during the assembly of the Happy Hollow

Shown to-scale

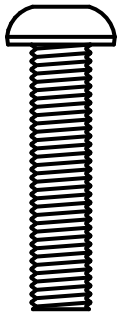

Bag B
Size: M8*35mm
Quantity: 17

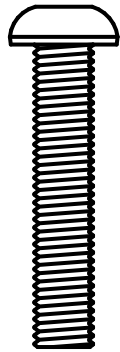

Bag C
Size: M8*40mm
Quantity: 13

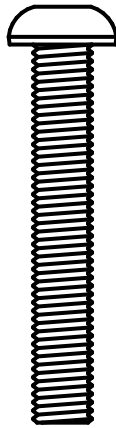

Bag D
Size: M8*50mm
Quantity: 7

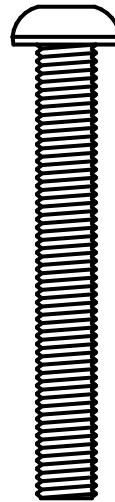

Bag E
Size: M8*60mm
Quantity: 2

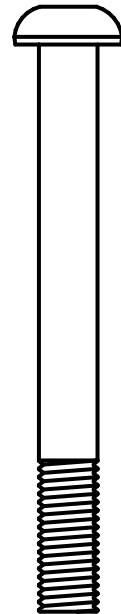

Bag F
Size: M8*75mm
Quantity: 3

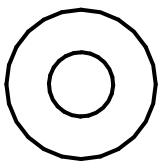

Bag G
Size: M8
Quantity: 44



Bag H
Size: M8
Quantity: 2



Bag I
Self Tapping Screw
Quantity: 2

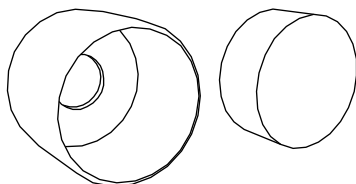

Bag J
Color: Light Blue
Quantity: 10

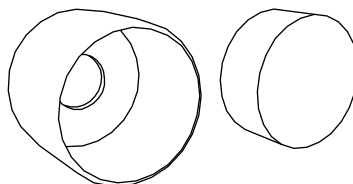

Bag K
Color: Light Green
Quantity: 12

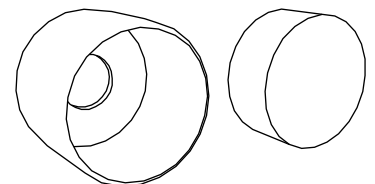

Bag L
Color: Dark Green
Quantity: 8

Optional Mounting Packages

Sold Separately

In-Ground Mounting Package

In-Ground Mounting Stakes

Qty: 4

Recommended Tools:

Hammer

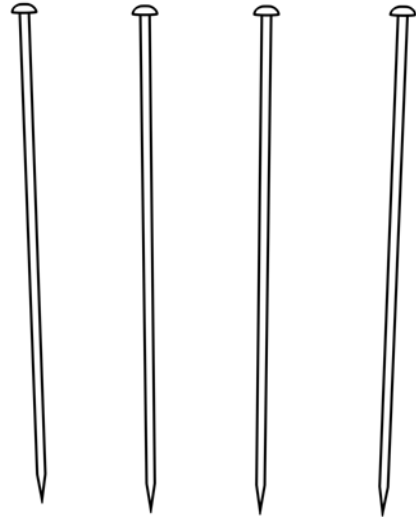

Surface Mounting Package

Surface Mounting Plates

Qty: 4

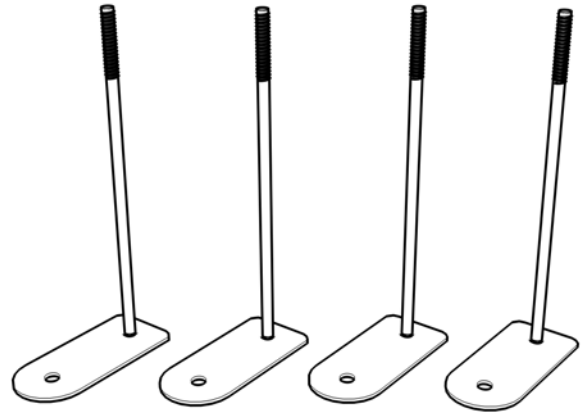

M10 Washer

Qty: 4



M10 Locking Nut

Qty: 4



Recommended Tools:

Socket Wrench

17mm Deep Well Socket

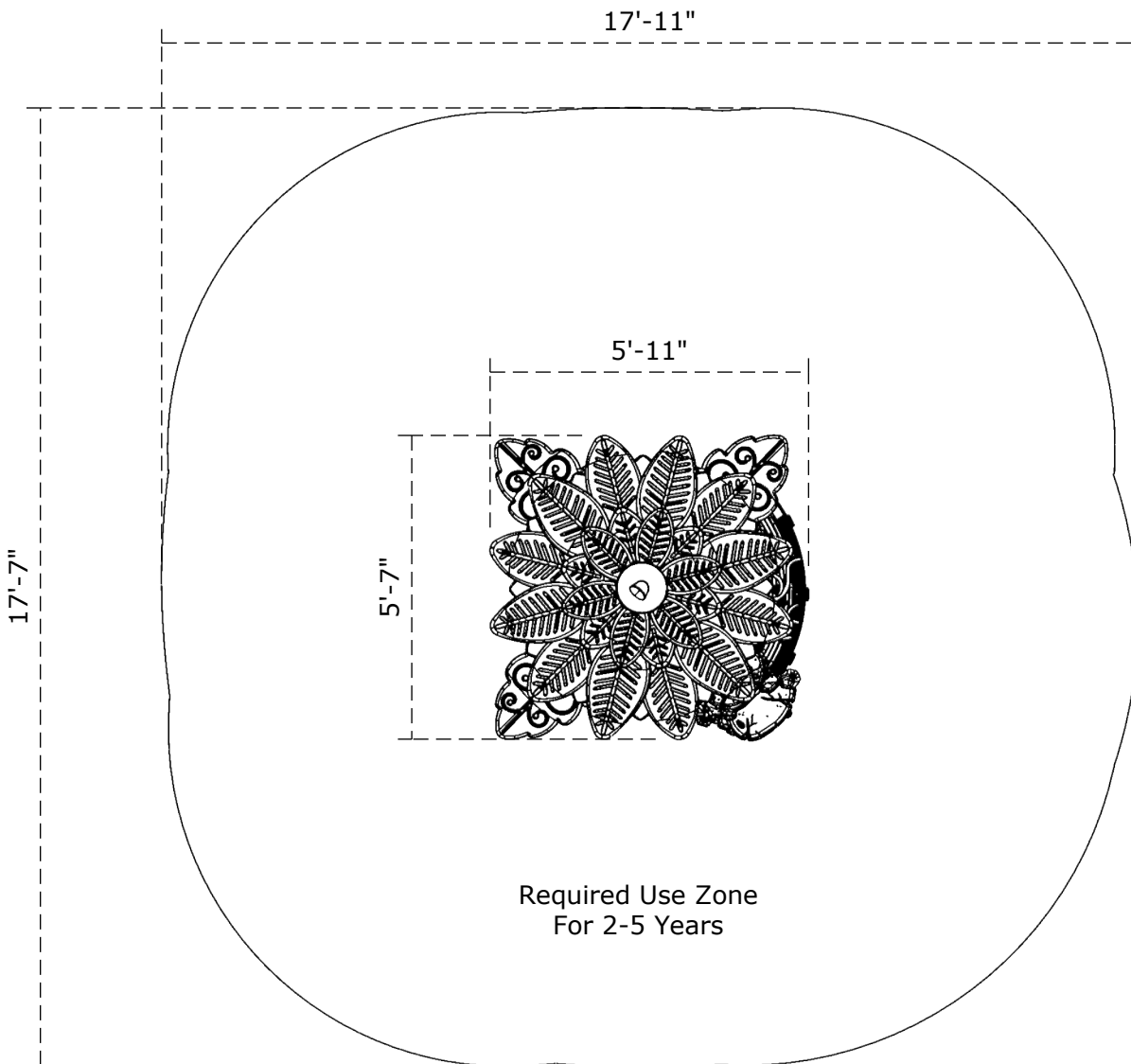
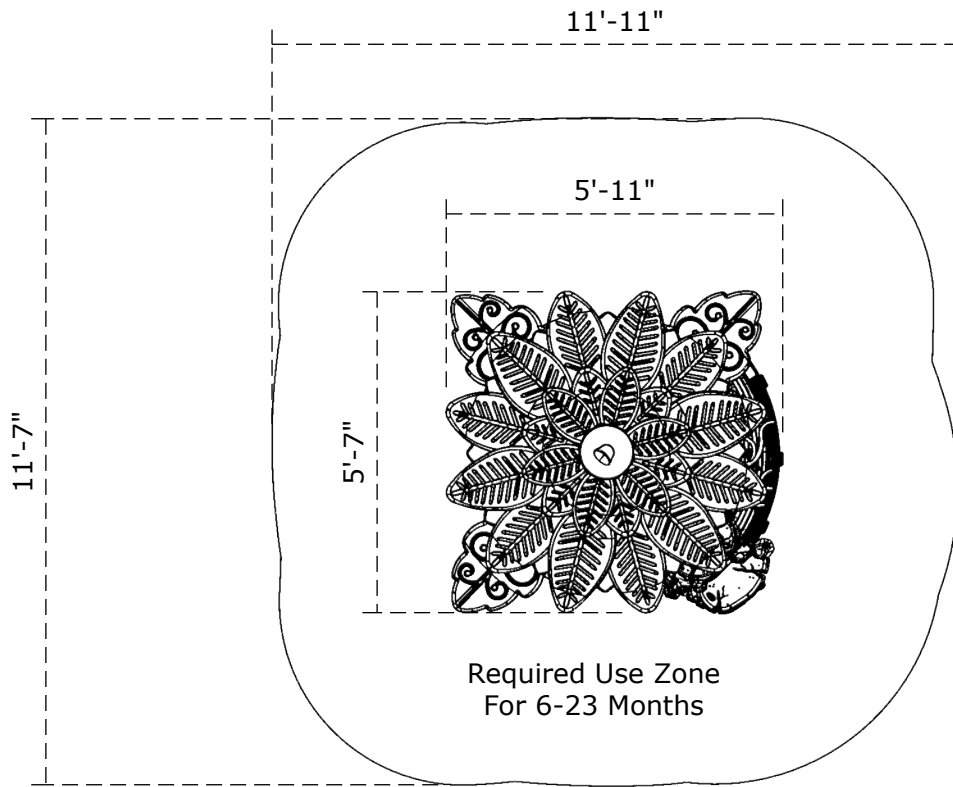

1

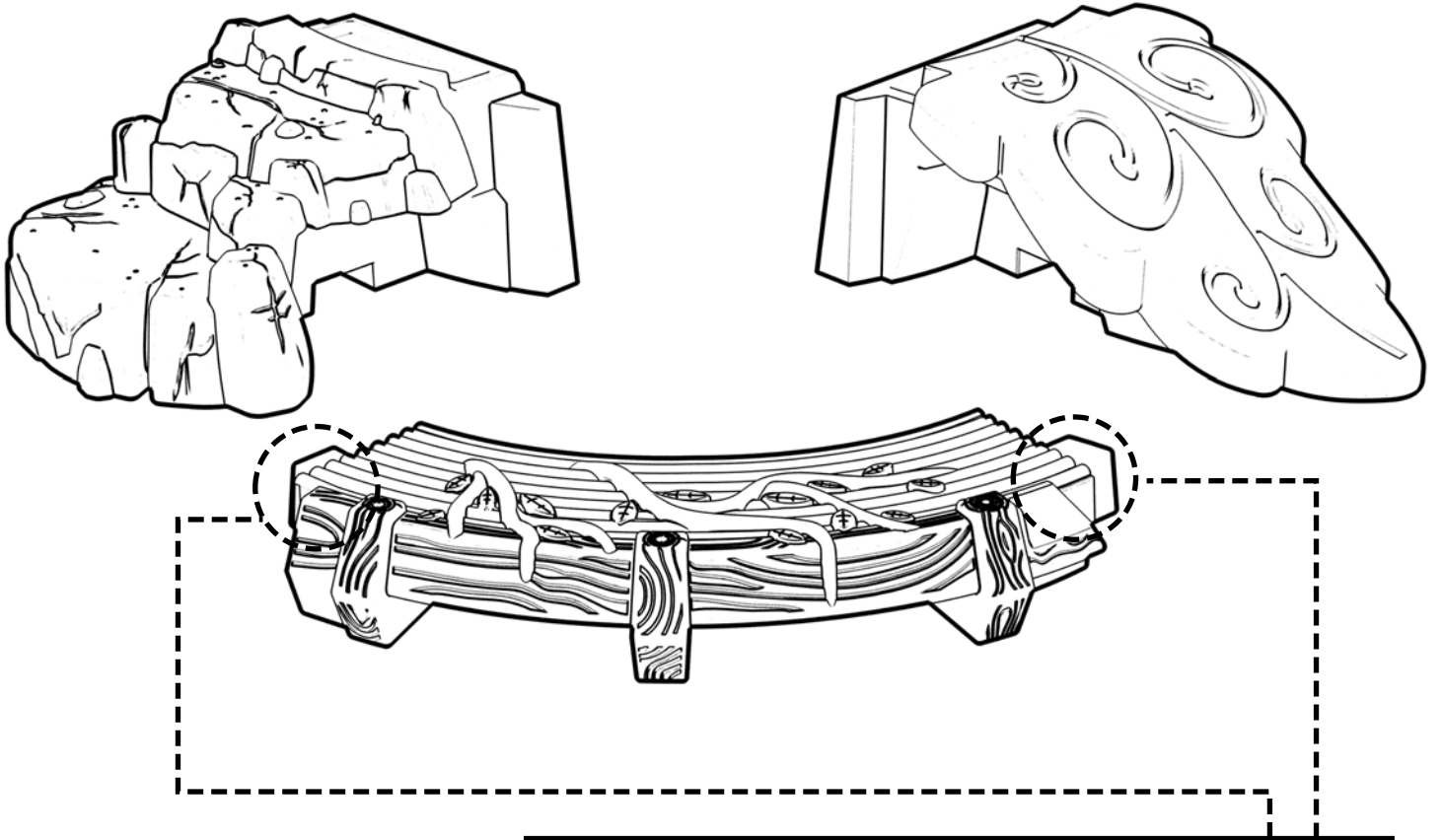

Hardware Needed:

B x2

G x2

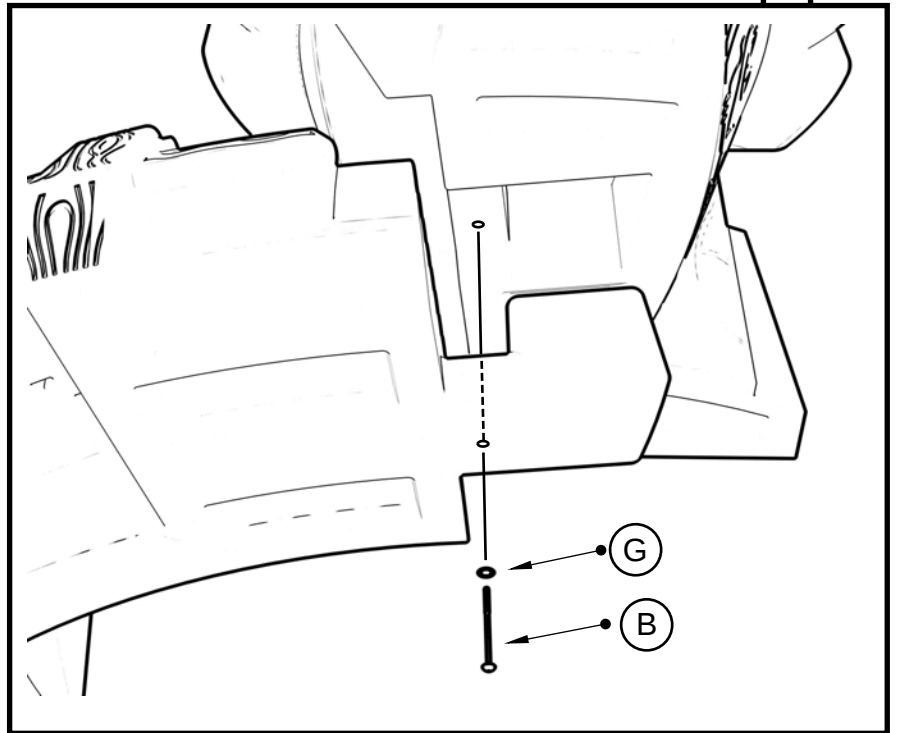

2

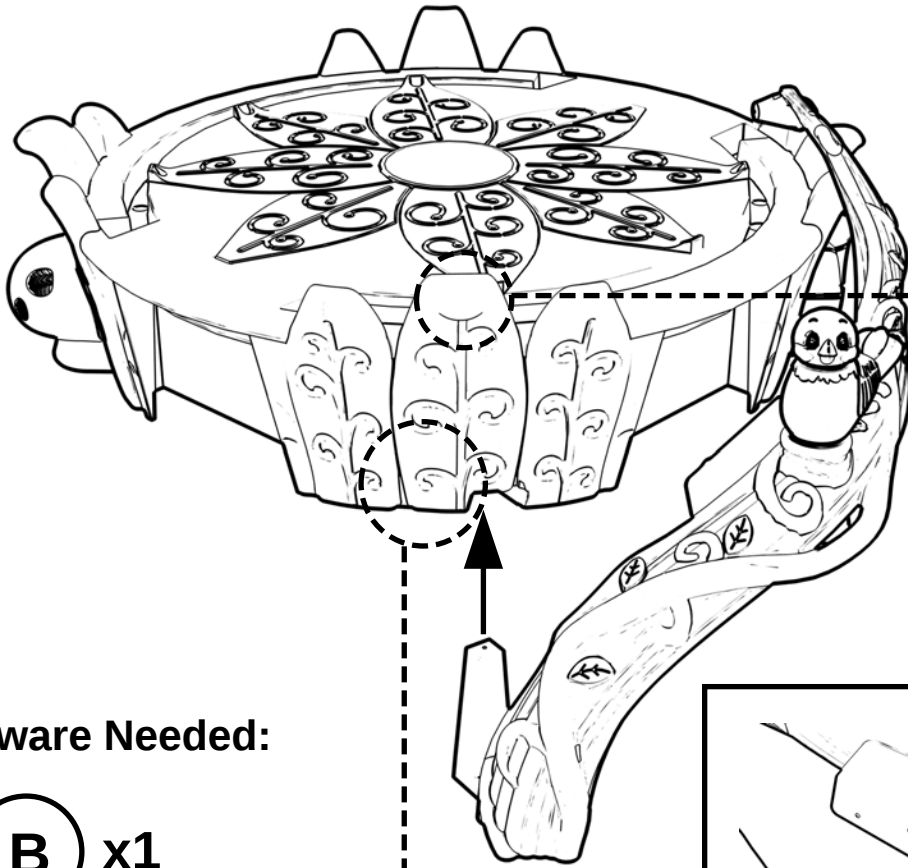

Hardware Needed:

- (B)** x1
- (D)** x1
- (G)** x2

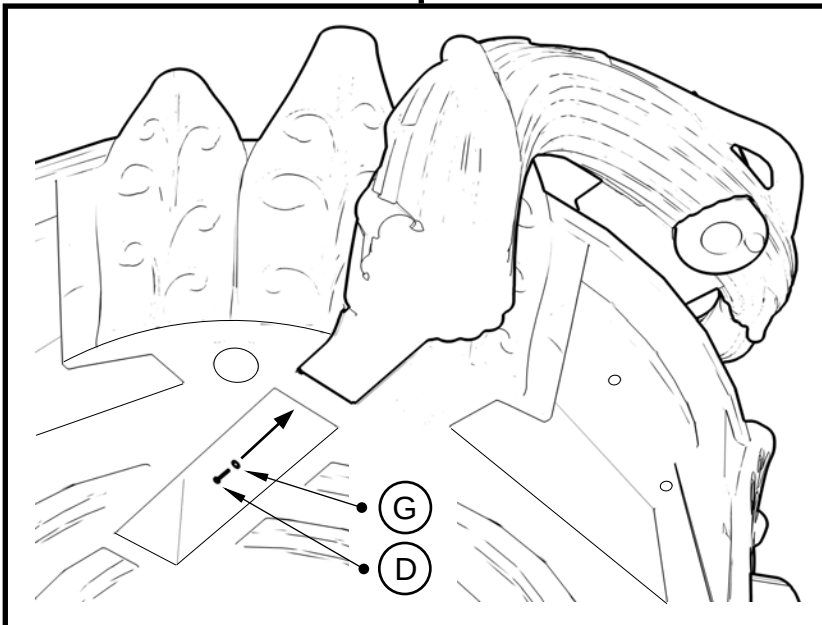
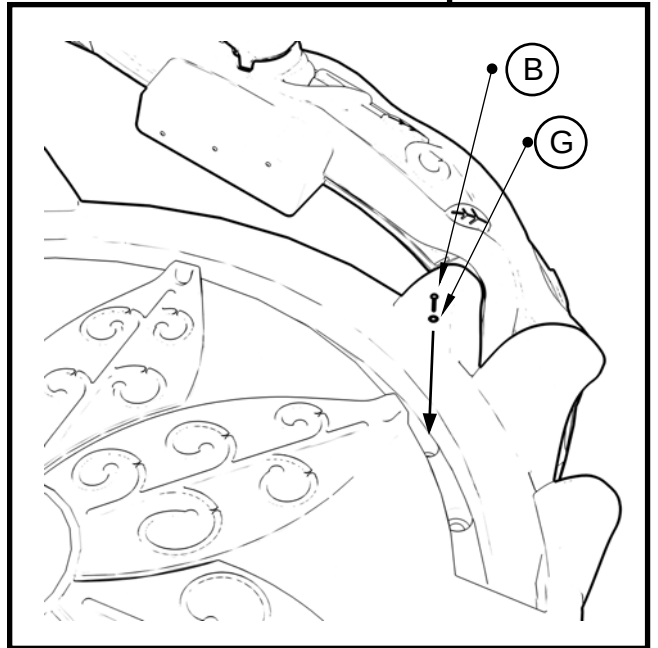

3a

Hardware Needed:

(B) x4

(G) x4

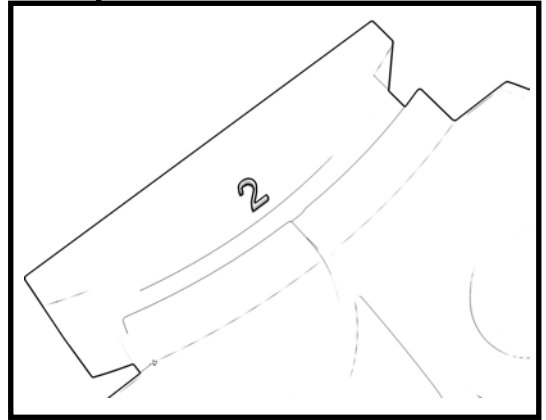
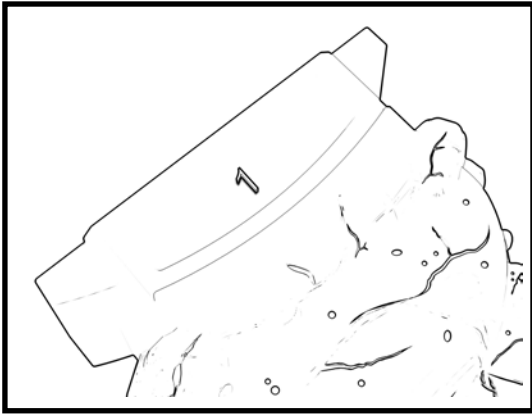
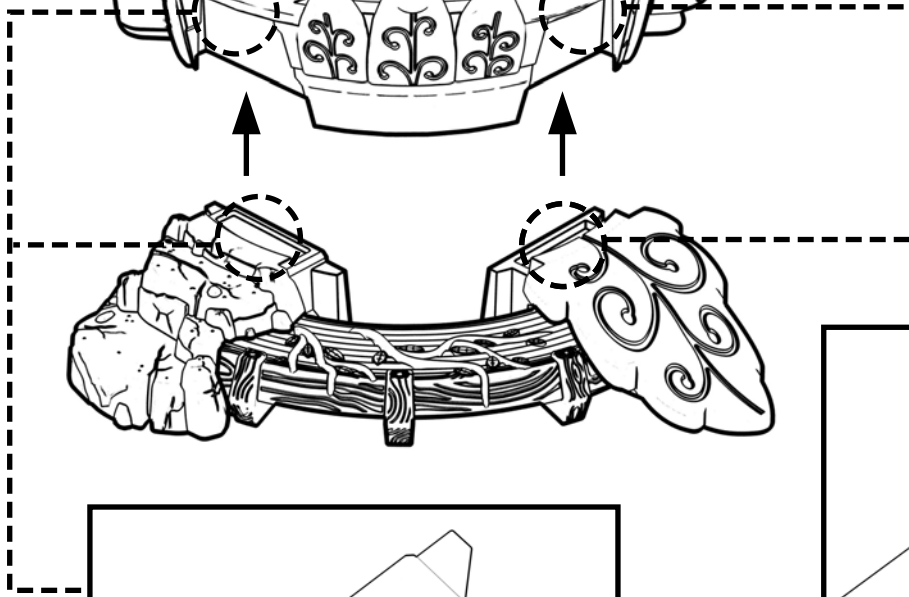

3b

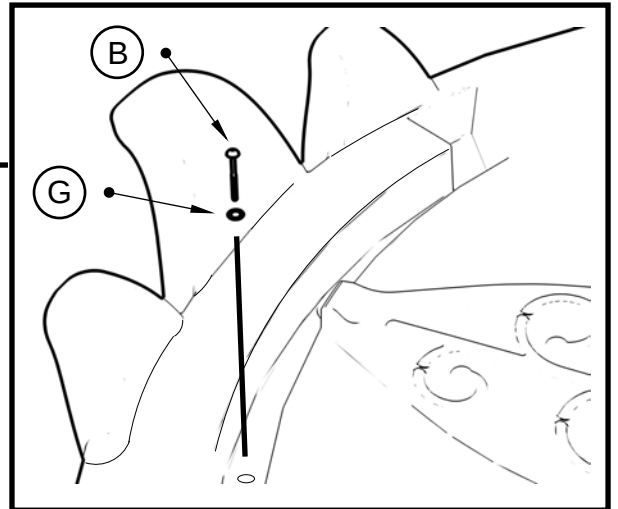
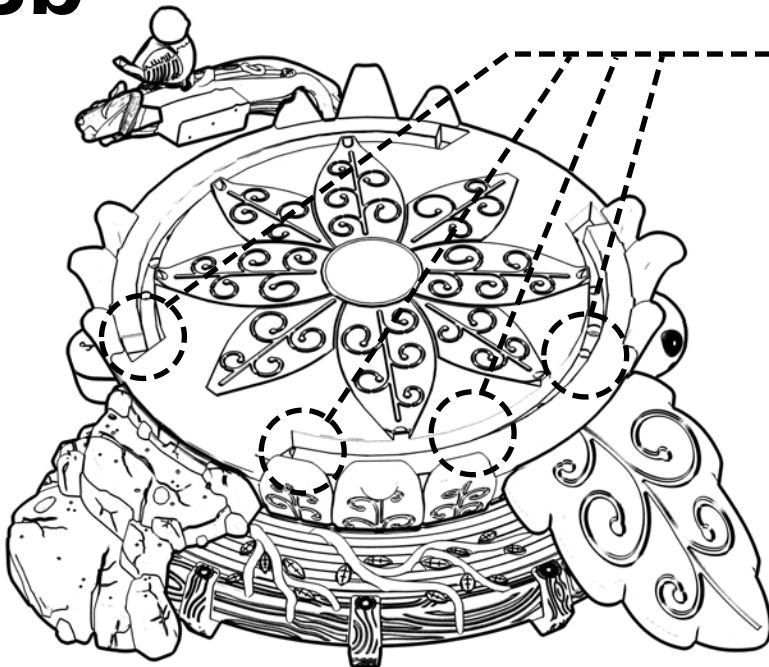

4a

Hardware Needed:

(B) x4

(G) x4

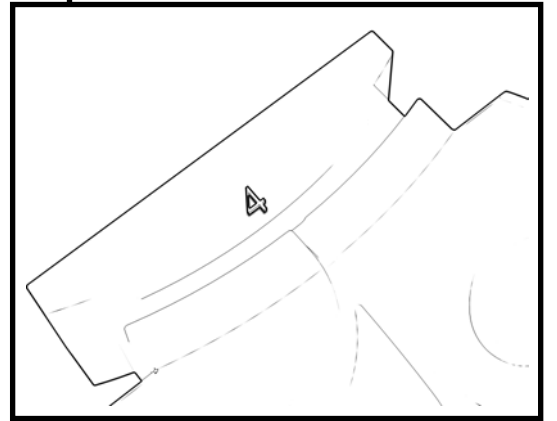
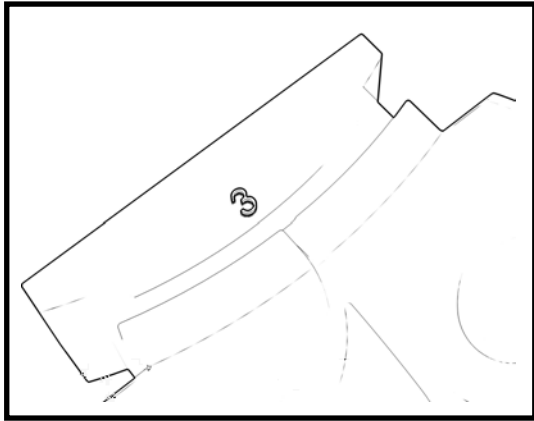
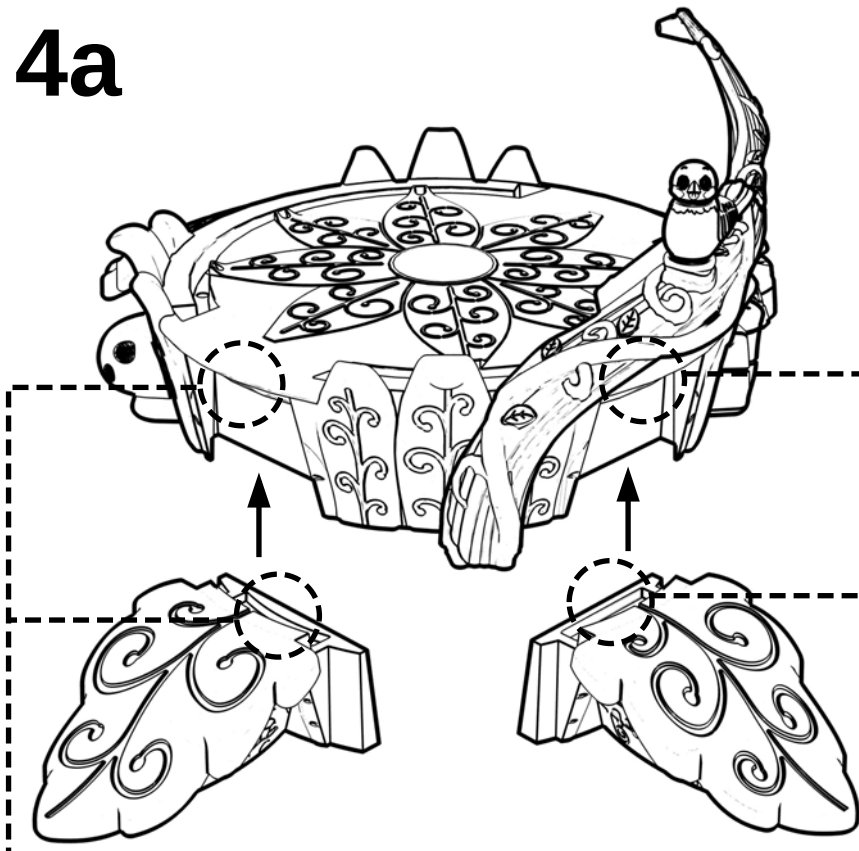

4b

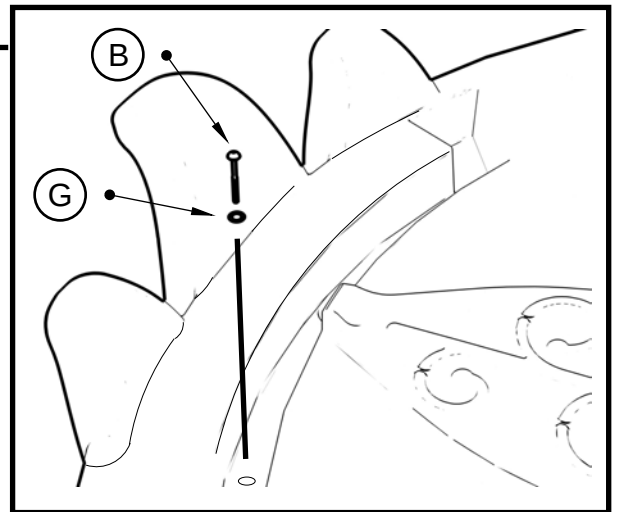
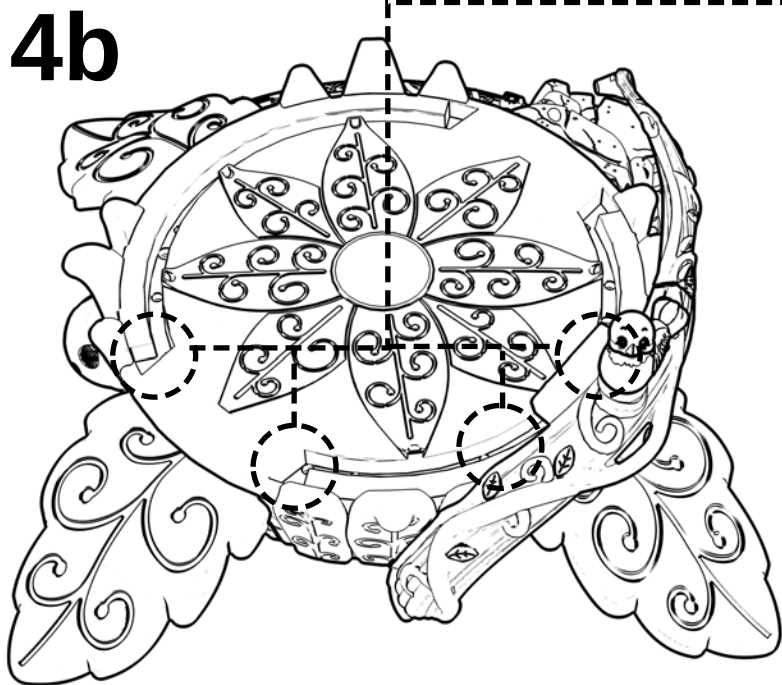

5 Optional Mounting Methods

Mount Packages Sold Separately

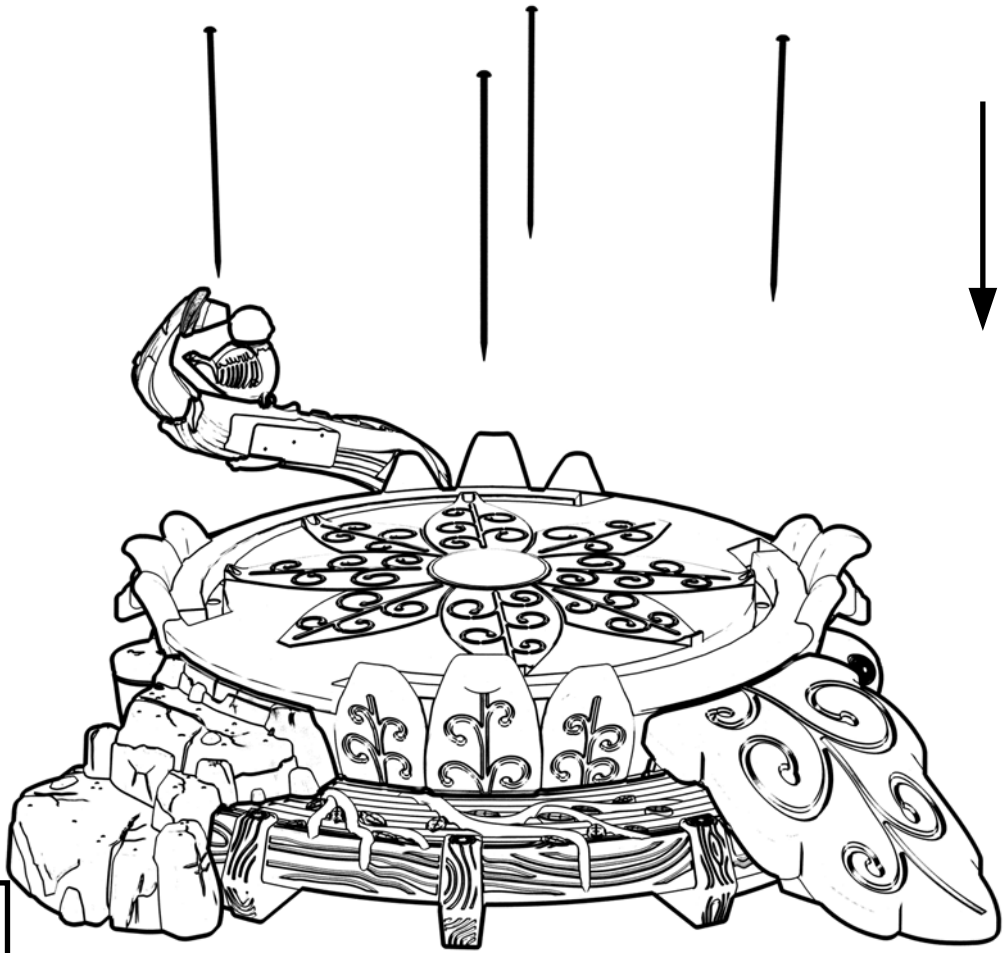

In-Ground Mounting Method

OR

Surface Mount Mounting Method

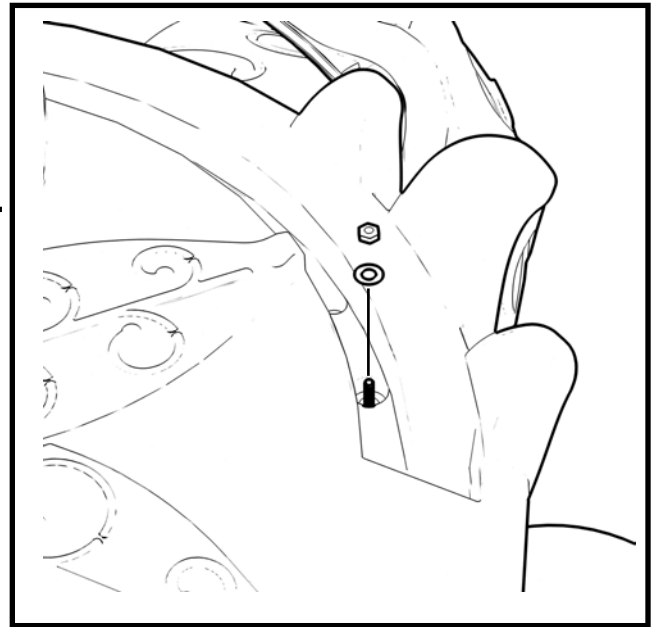
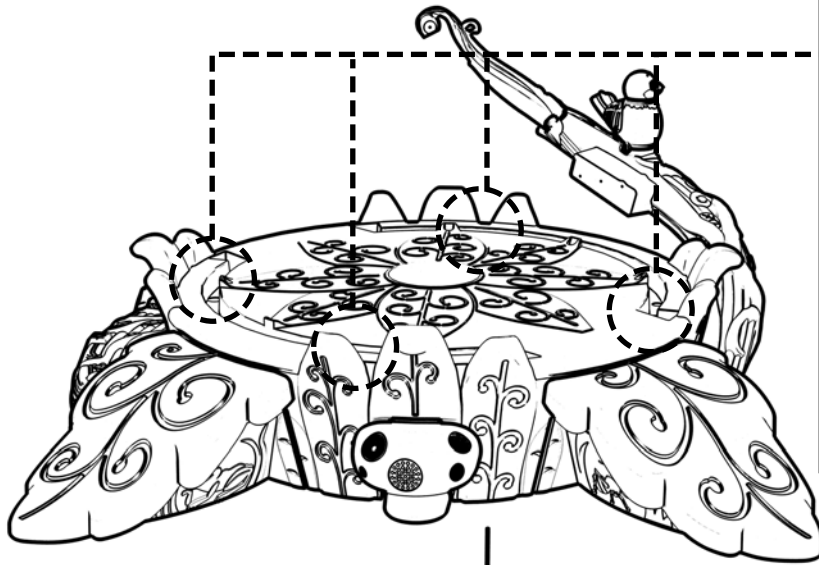

Hardware packaged with the mounting brackets

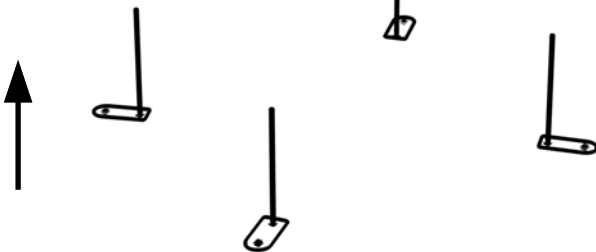

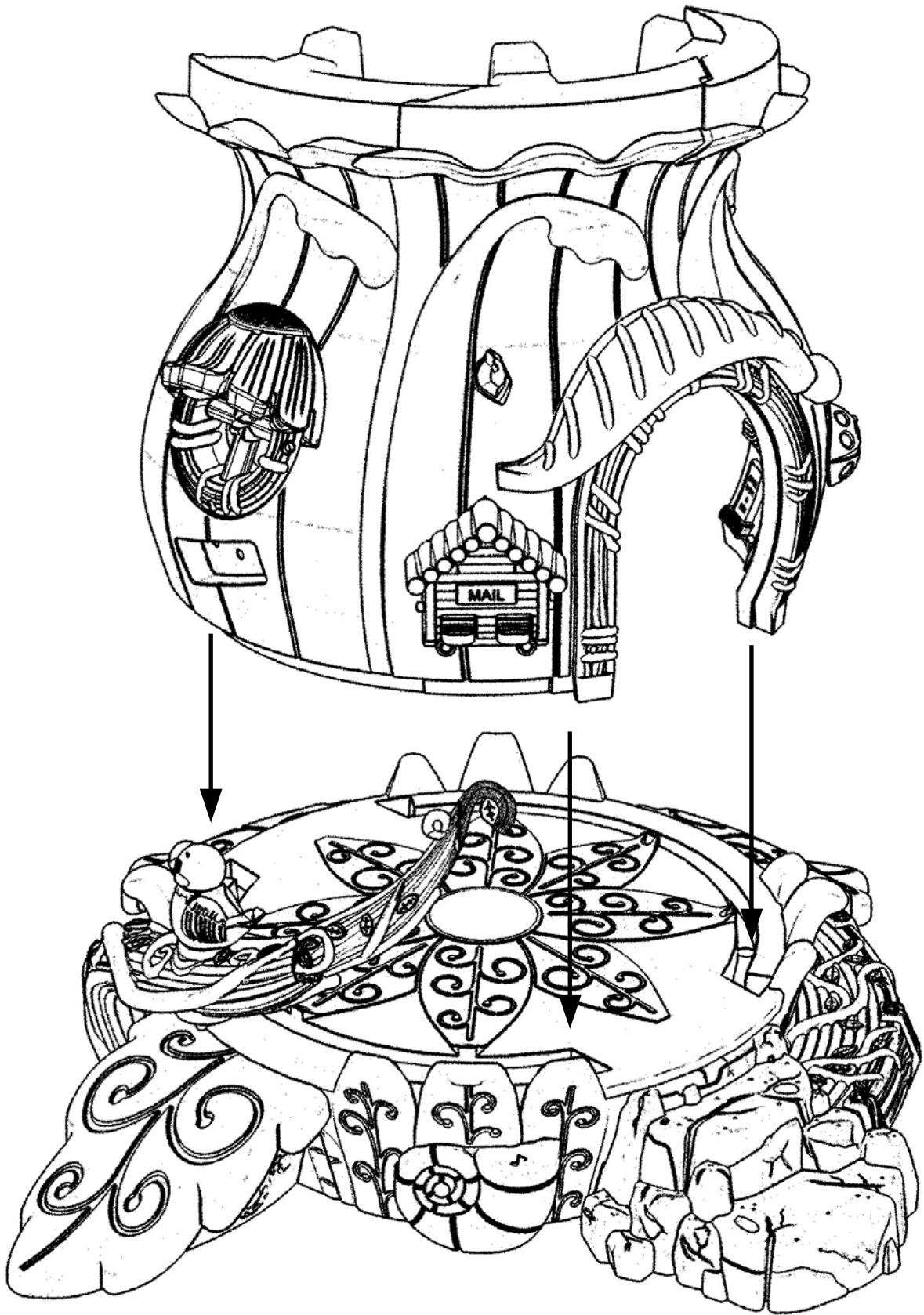

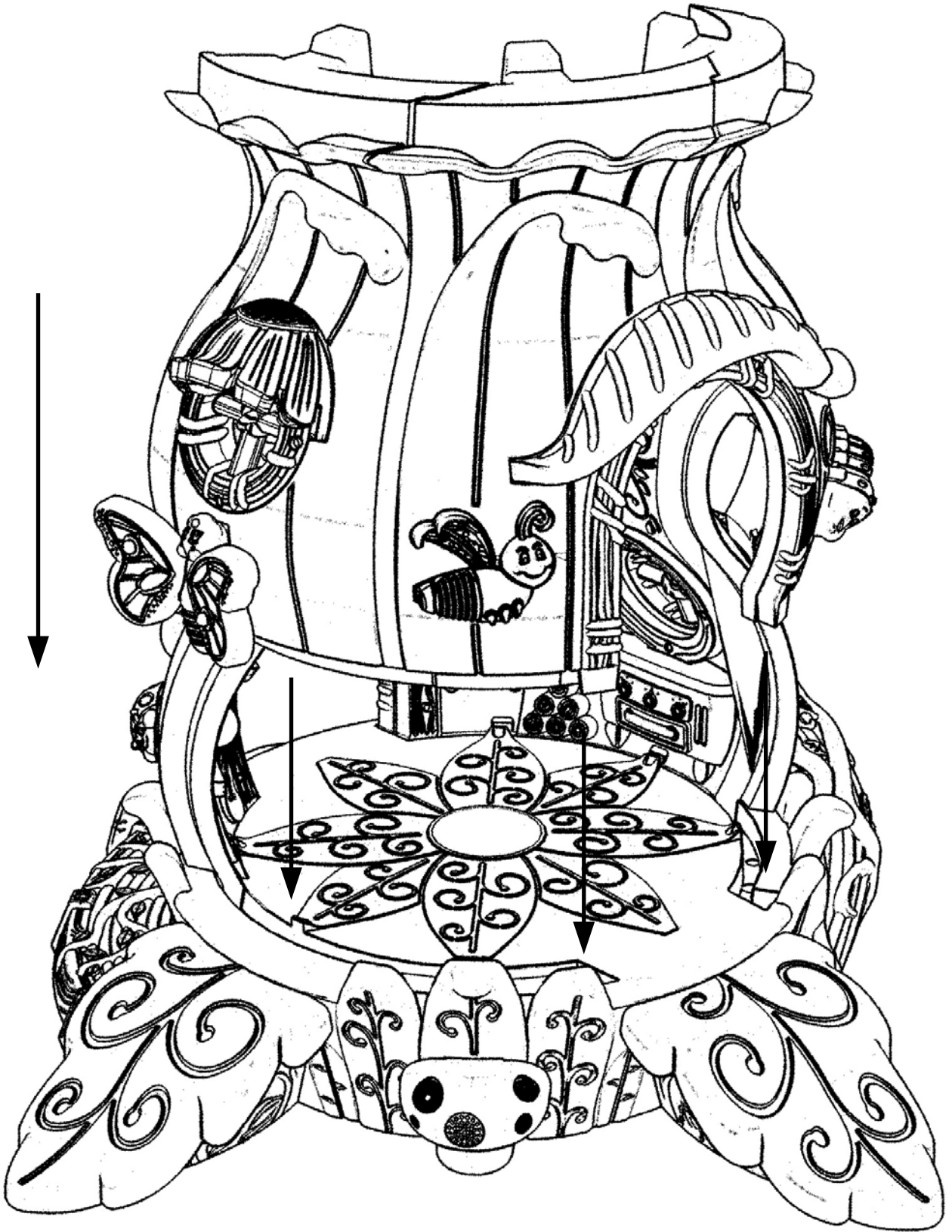

8

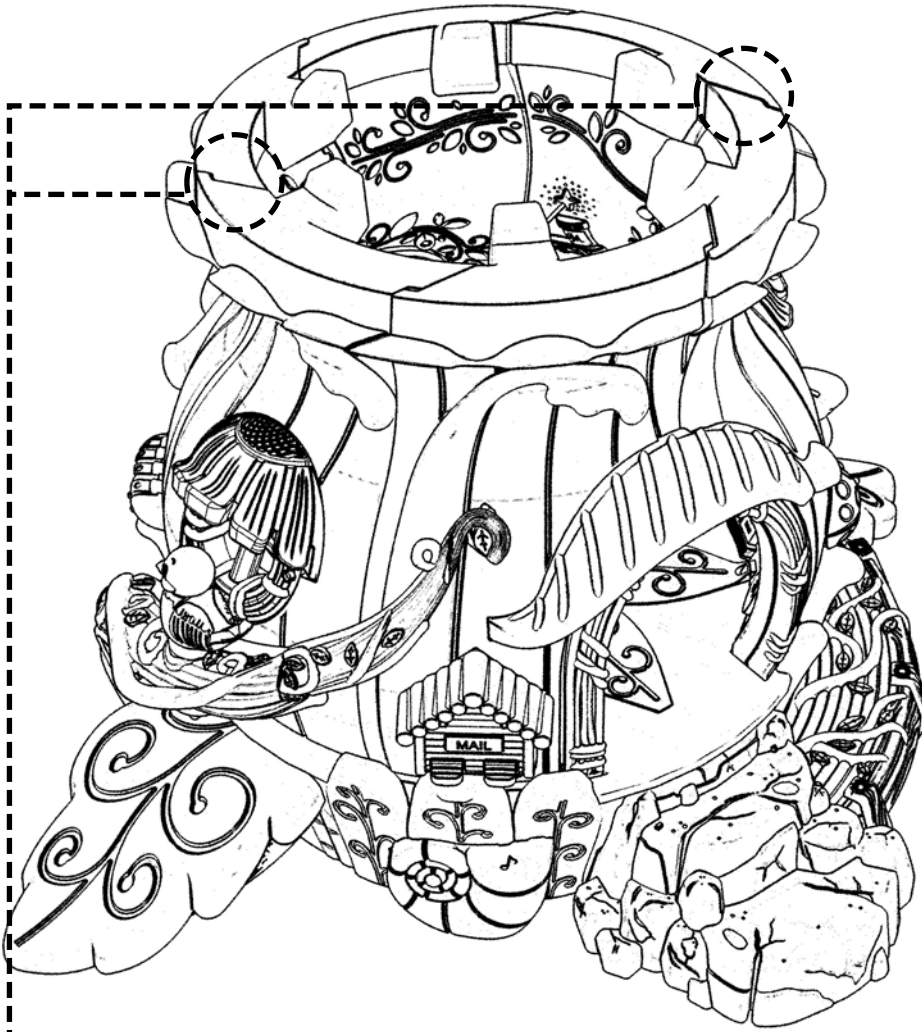

Hardware Needed:

(E) x2

(G) x4

(H) x2

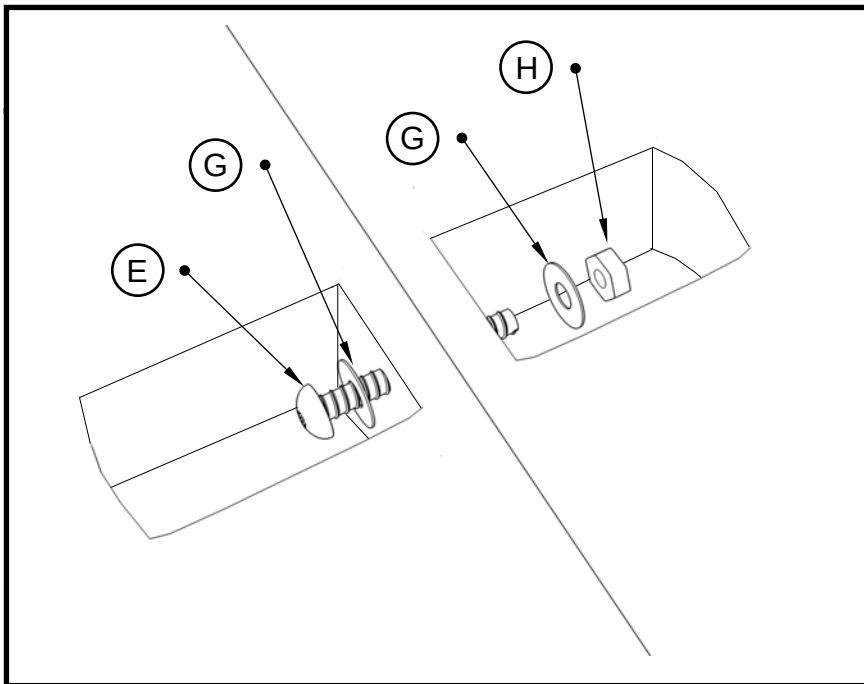

9

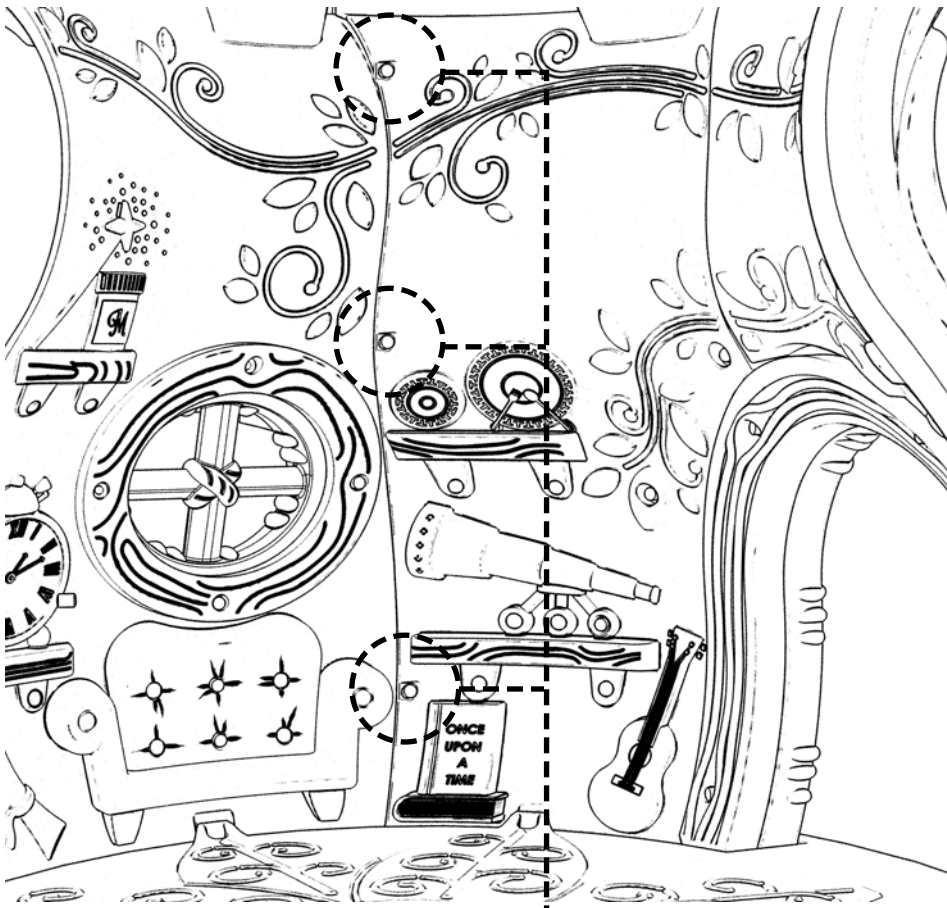

Hardware Needed:

B x6

G x6

J x6

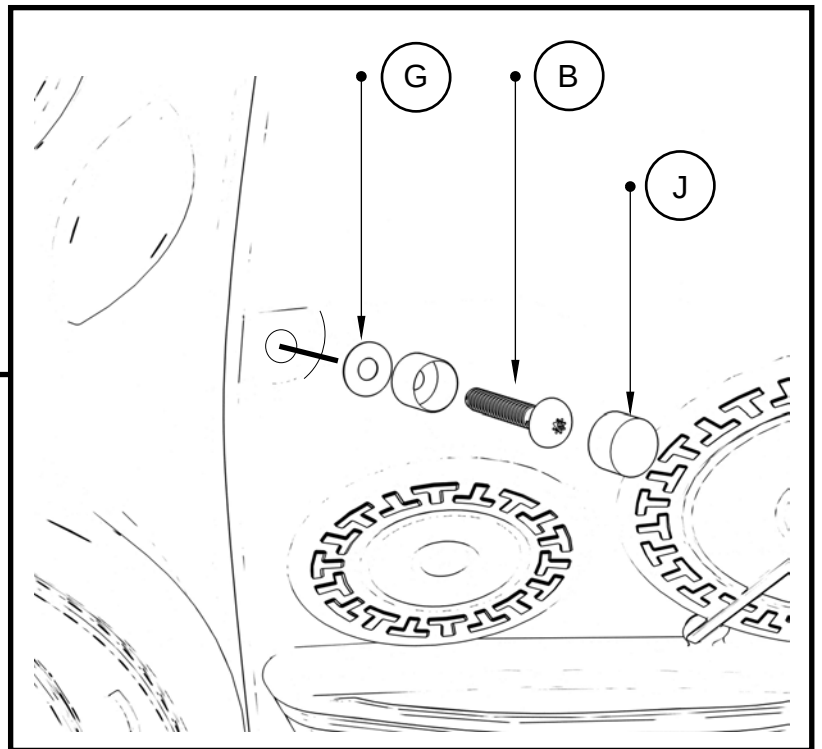

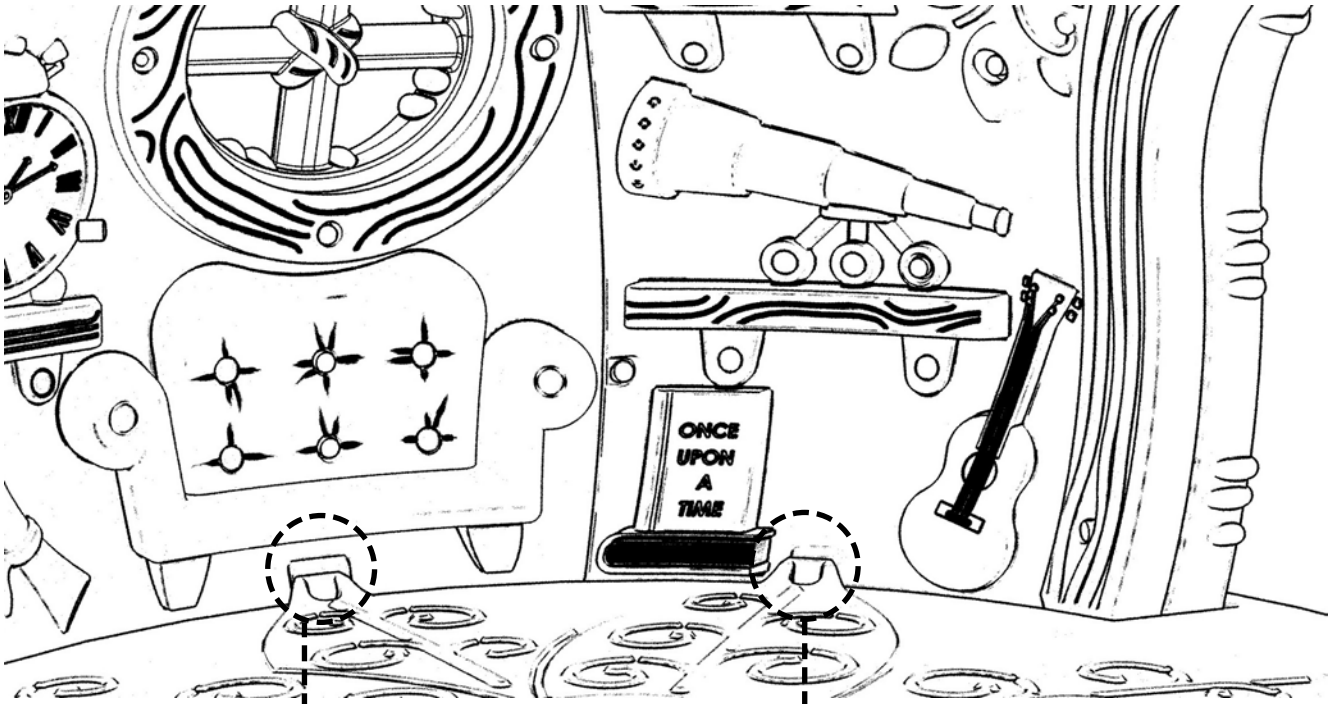

Hardware Needed:

(C) x6

(G) x6

(L) x6

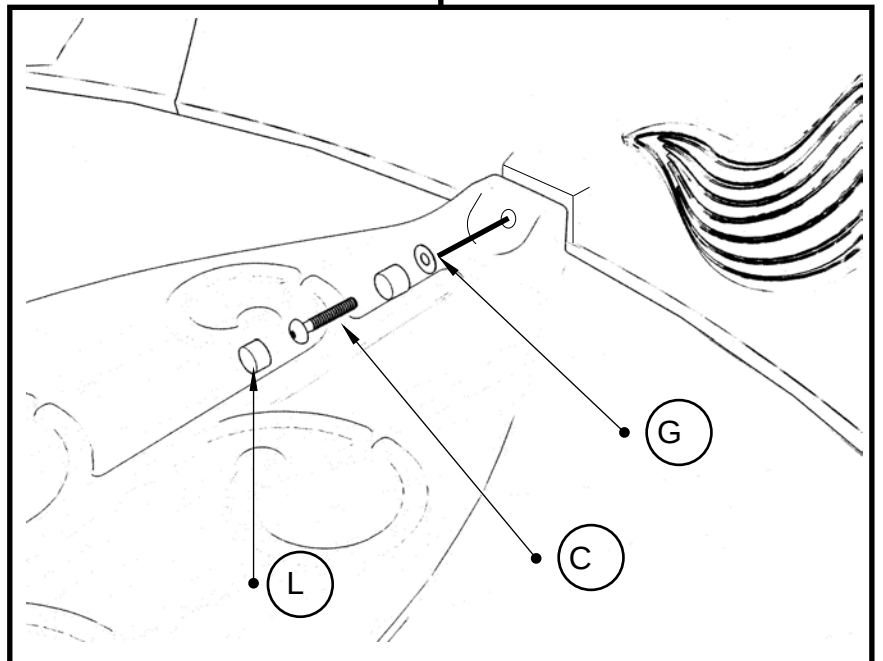

11

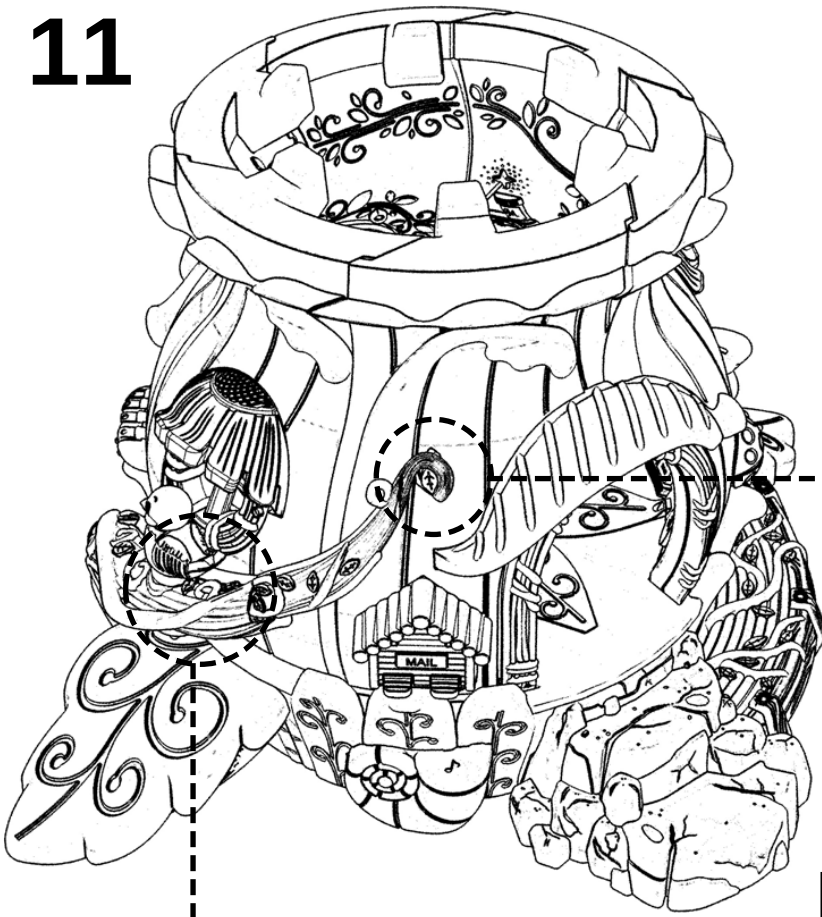

Hardware Needed:

(C) x1

(F) x3

(G) x4

(J) x4

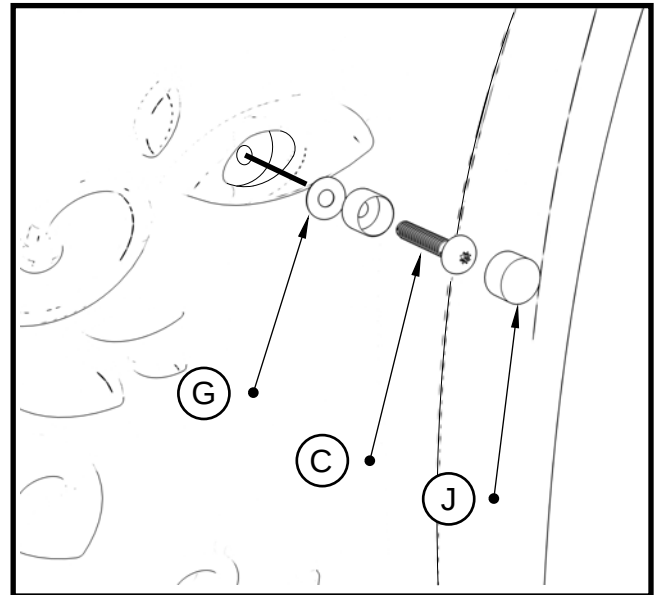
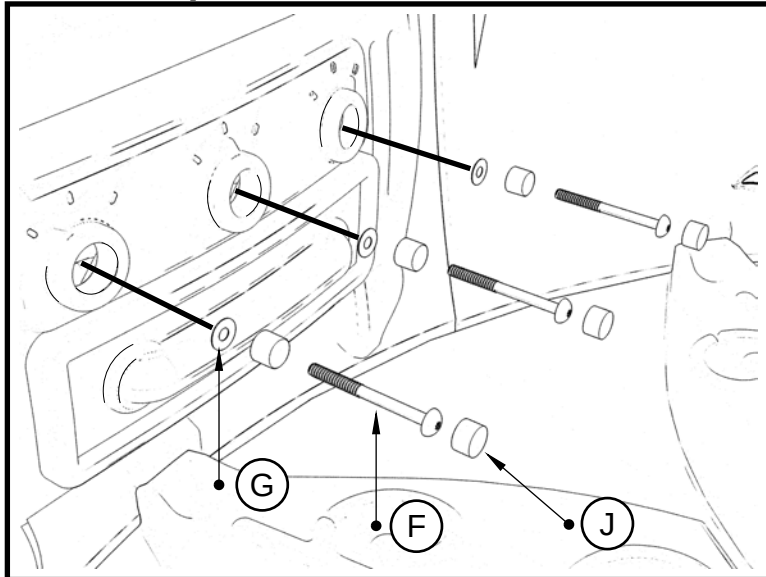

Hardware Needed:

D x6

G x8

I x2

K x6

L x2

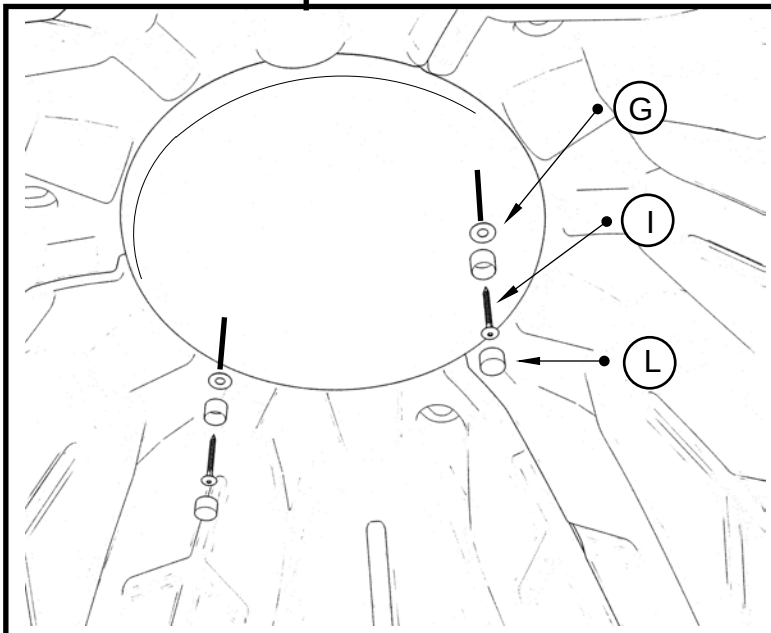
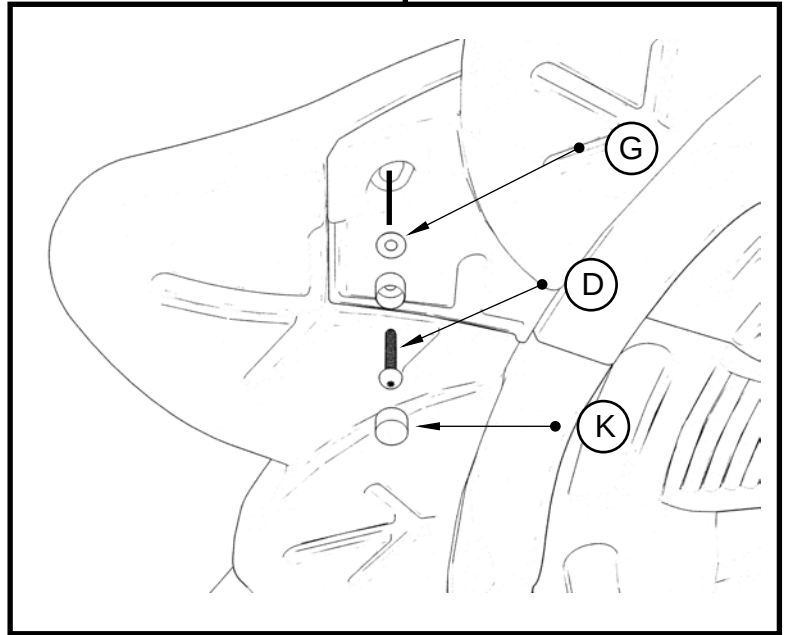
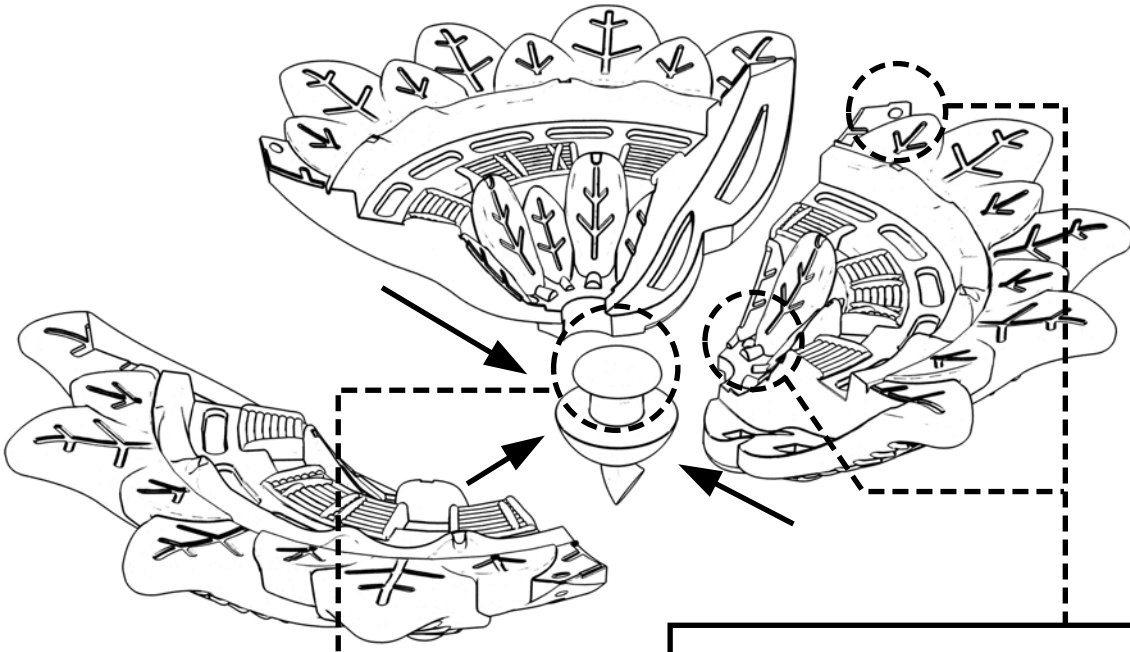

13

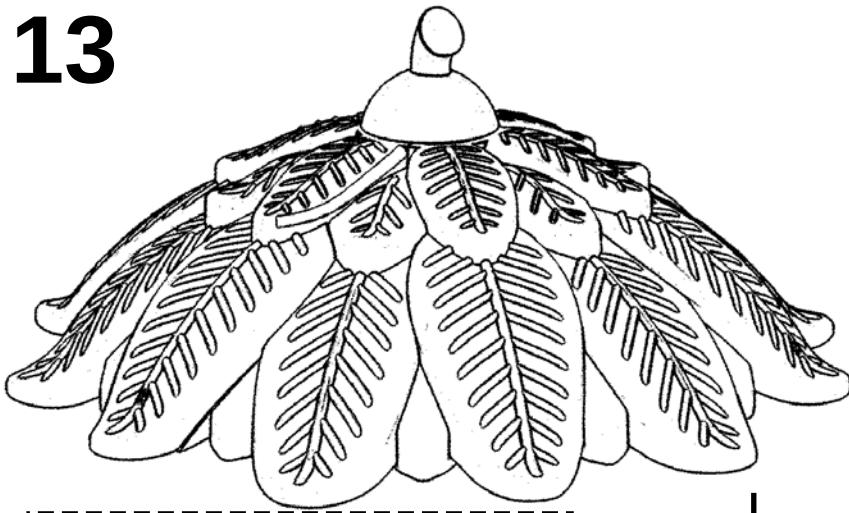

Hardware Needed:

C x6

G x6

K x6

