

GLRA-81

LAT/ROW ATTACHMENT

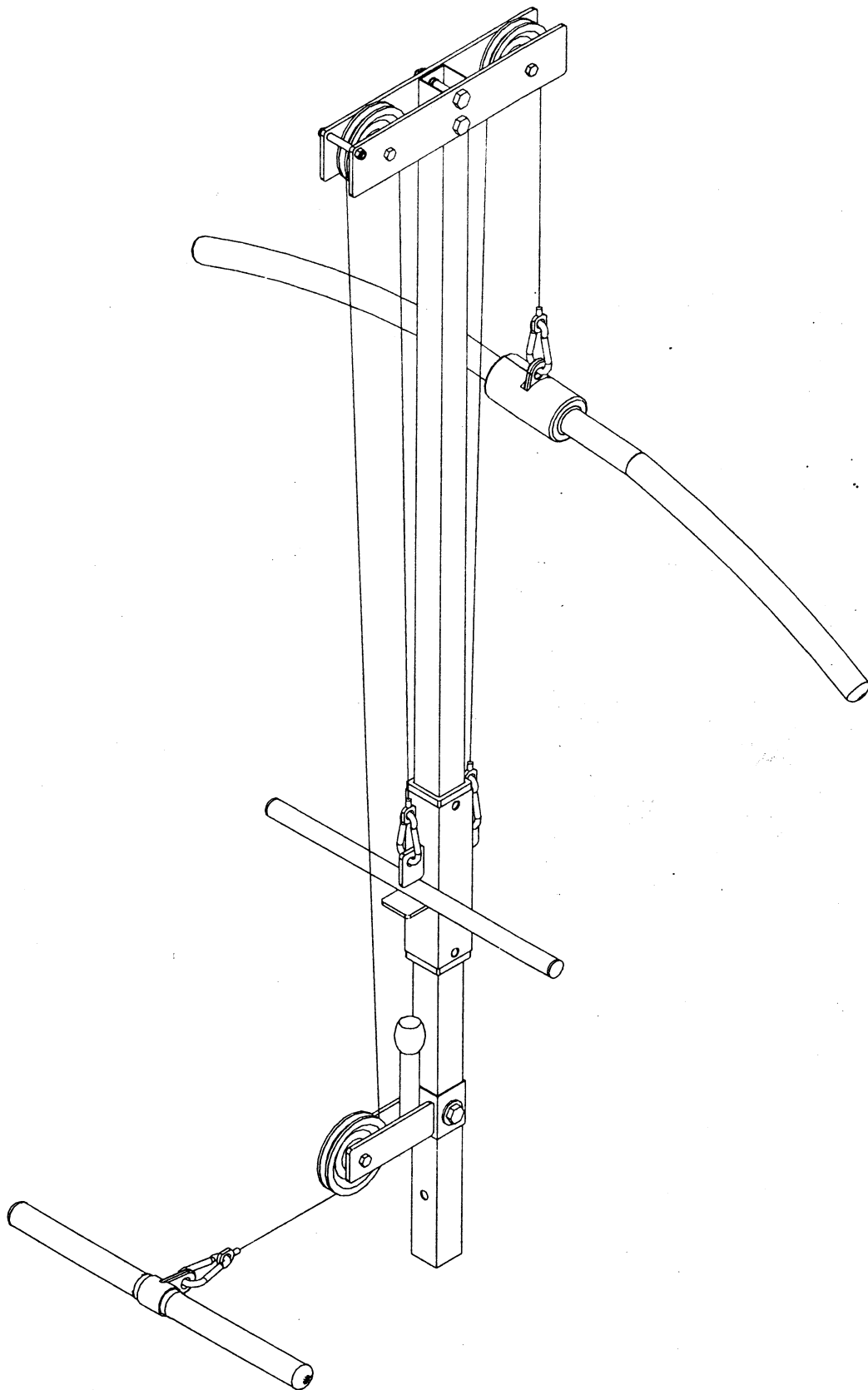

VERSION 0511

# GLRA-81

## HARDWARE ILLUSTRATION SHEET

## PARTS ILLUSTRATION SHEET

Part No.	Description	Qty.
A1.	M12X75 HEX HEAD BOLT	[2PCS]
A2.	M12X70 HEX HEAD BOLT	[1PCS]
A3.	M10X75 HEX HEAD BOLT	[2PCS]
A4.	M10X50 HEX HEAD BOLT	[1PCS]
B1.	M12 NYLON LOCK NUT	[3PCS]
B2.	M10 NYLON LOCK NUT	[3PCS]
B3.	M8 NYLON LOCK NUT	[2PCS]
C1.	M12 (I.D.) WASHER	[2PCS]
D1.	M8X75 SHAFT BOLT (8260-003)	[1PCS]
D2.	Ø1" ROUND END CAP (9260-021)	[4PCS]
D3.	60X45 NYLON BUSHING (9211-032)	[2PCS]
D4.	Ø1" ROUND END CAP (9211-016)	[2PCS]
D5.	Ø4 1/4"X21t PULLEY (9213-002)	[3PCS]
D7.	Ø1" RUBBER CANE TIP (9212-019)	[1PCS]
D8.	Ø8 SPRING SNAP LINK (8810-001)	[4PCS]
D9.	3280mm STEEL CABLE	[1PCS]
D10.	1550mm STEEL CABLE	[1PCS]

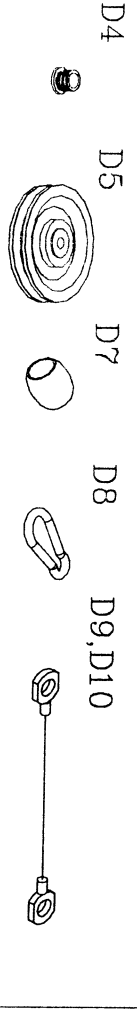

A [1PCS] C [1PCS]

B [1PCS]

D [1PCS]

E [1PCS]

F [2PCS]  
8313-043

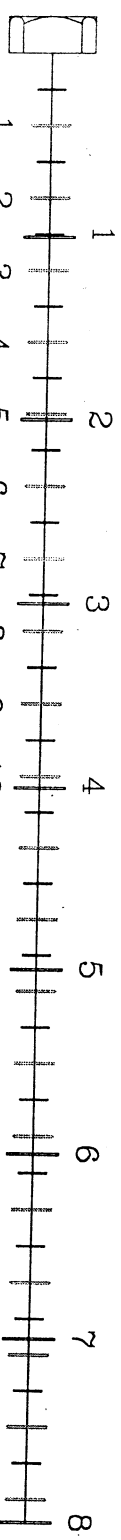
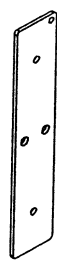
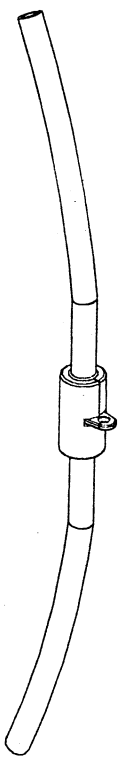
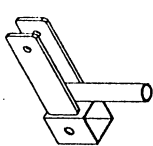
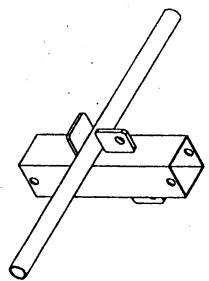

# GLRA-81

