

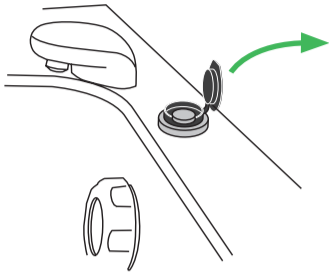

Freedom Bath

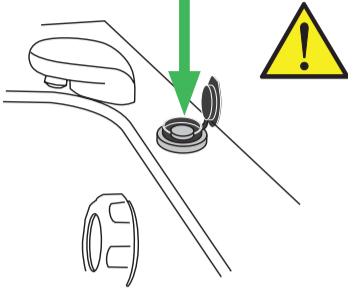
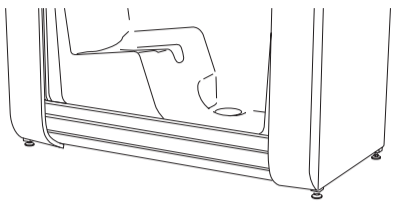

Emergency seal release

 <p>For medical emergency during bathing, perform step 1-3.</p> <p>For power failure, drain the bathtub before performing step 1-3.</p>	<p>1</p>  <p>Open the lid.</p>	<p>2</p>  <p>Push the button. The drain opens and water rushes out around the door.</p>	<p>3</p>  <p>Manually push the door down.</p>
--	--	---	---

Inflatable door seal

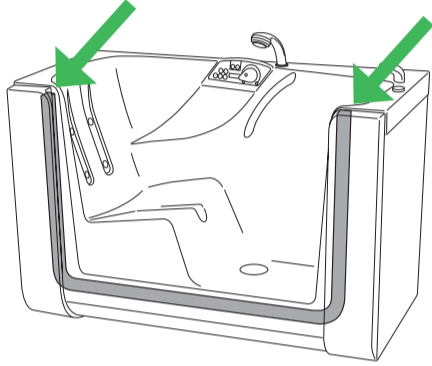

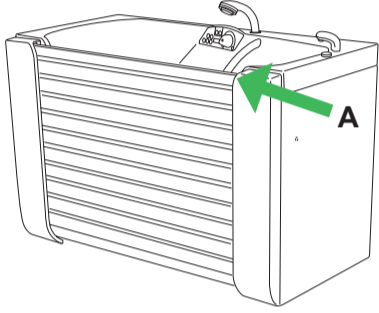
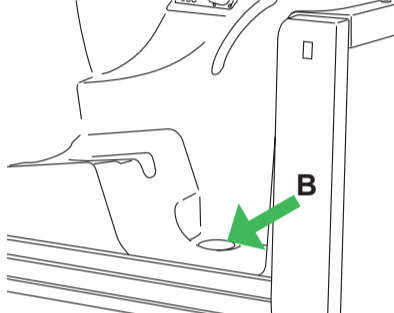

Activate the inflatable sealing system to make the door watertight. Raise the door and press the door seal/drain button. When not in use, leave door raised with the seal deflated.

Automatic drain



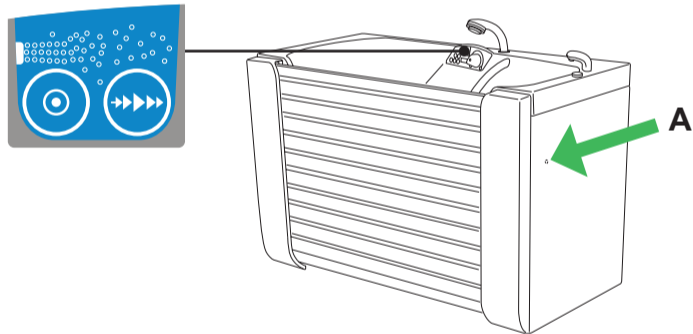

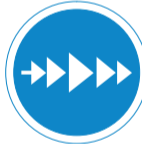
The drain only closes when the door is raised to top position (A). When the sealing system is deactivated, the drain opens (B).

Air spa system (optional feature)

<p>1</p>  <p>Raise the door to top position and fill the bathtub above the high water level sensor button (A).</p>	<p>2</p>  <p>Press the ON/OFF button, the air blower starts at maximum speed.</p>	<p>3</p>  <p>Press and hold air speed button to reduce intensity. Release button when desired intensity is reached.</p>	<p>4</p>  <p>Press the ON/OFF button to stop the air blower.</p>
--	---	---	--

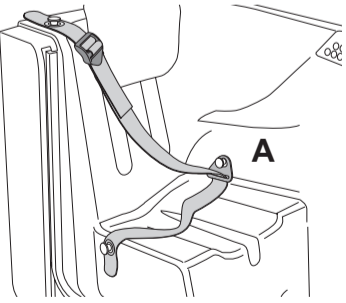
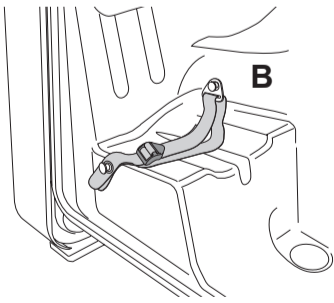
Safety belt (optional feature)

Fasten the safety belt according to A or B. Adjust the length by pulling the safety belt end by the clip.