

FIREFLY™



RIO 
MOBILITY

Electric Handcycle Attachment Firefly™ 2.5 User Manual

Ver 1.4.2 12_21_2021

IMPORTANT!

Consult with your health care professional to determine if the Firefly™ 2.5 is appropriate for you.

DO NOT OPERATE THIS EQUIPMENT WITHOUT FIRST READING AND UNDERSTANDING THIS MANUAL. IT IS RECOMMENDED THAT INITIAL SETUP OF THIS HANDCYCLE BE PERFORMED BY A QUALIFIED TECHNICIAN, SUCH AS A WHEELCHAIR OR BICYCLE MECHANIC. TO OPTIMIZE SETUP IT IS SUGGESTED THE CUSTOMER BE SEATED IN THE WHEELCHAIR AT THE TIME OF INITIAL INSTALLATION. AS WITH ANY THREE-WHEELED VEHICLE, SIDE-TO-SIDE STABILITY IS DECREASED COMPARED TO A WHEELCHAIR ALONE, SO USE CAUTION WHEN TURNING AT HIGH SPEEDS.

Follow the recommendations in your wheelchair manual.

The Firefly™ 2.5 is intended for use for mobility in sporting and/or recreational purposes only and is not intended as an exclusive means of mobility. Check local vehicle/wheelchair regulations.

The operation of a handcycle involves a certain level of risk and the potential for serious bodily injury.

1. Wheelchair Requirements

As part of our installation process, you will attach our mounting clamps onto your wheelchair.

Our wheelchair attachments fit most wheelchairs. However, a few wheelchairs will not fit our clamps. Use this guide to determine if our devices are right for you.

There are *five* points that must be considered in order to determine whether your wheelchair is compatible with our wheelchair attachments:

1) Seat width: must be between 14 to 22 in -or- 35.5 to 55.8 cm (measured **end-to-end** on the width of your seat cushion).

2) Tube diameters: currently supported tubing diameters are: (**printable tubing ruler on next page**).

- 7/8 in -or- 22.2 mm
- 1 in -or- 25.4 mm
- 1.125 in -or- 28.6 mm
- 1.2 in -or- 30.5 mm
- 1.25 in -or- 31.8 mm

3) Tube clearance: to attach the clamps, 1.25 in -or- 32 mm clearance is required. Diagrams with examples of tube clearances are given in the following pages.

4) Tube angle: ideally the tubes should be vertical or close to vertical. However, installation is possible with tubes that taper inwards with slight angles, the larger the taper angle the more challenging it is to use our “Quick Release Coupler” attachment. See the diagrams on the following pages where illustrations of wheelchair designs with tapering tube angles are shown.

5) Footrests on folding chairs: removable footrests can pose challenges for our clamp installation, so please consult below where examples of wheelchair designs with removable footrests are given. Never mount our clamps directly onto removable footrests as they were not designed to take such riding forces.

The Firefly™ 2.5 is compatible with almost all wheelchairs without the need for any special adapters.

<p>Anti-Tips & Seatbelts</p>	<p>When seated in the wheelchair, your center of gravity must be far enough forward as to make “wheelies” or tipping backwards difficult. IMPORTANT: If the chair is set up such that “wheelies” are easy, it may be unstable while attaching or detaching the handcycle. Anti-tips MUST be installed on your wheelchair. A seat belt is also strongly recommended.</p>
<p>Wheel Locks</p>	<p>Wheelchairs must have Wheel Locks installed.</p>
<p>Weight</p>	<p>Combined wheelchair and user weight must be less than 130kg/280lb.</p>

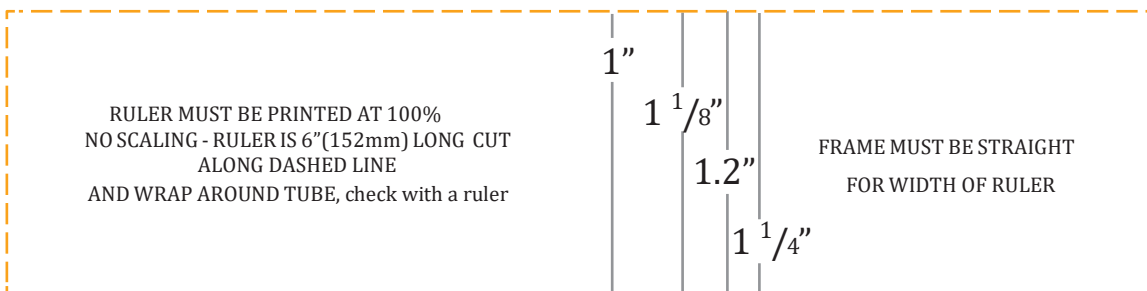

Compatibility Guide for Rigid Wheelchairs

All of our devices require about 1.25 in -or- 32 mm of clearance on the upper frame tubing.

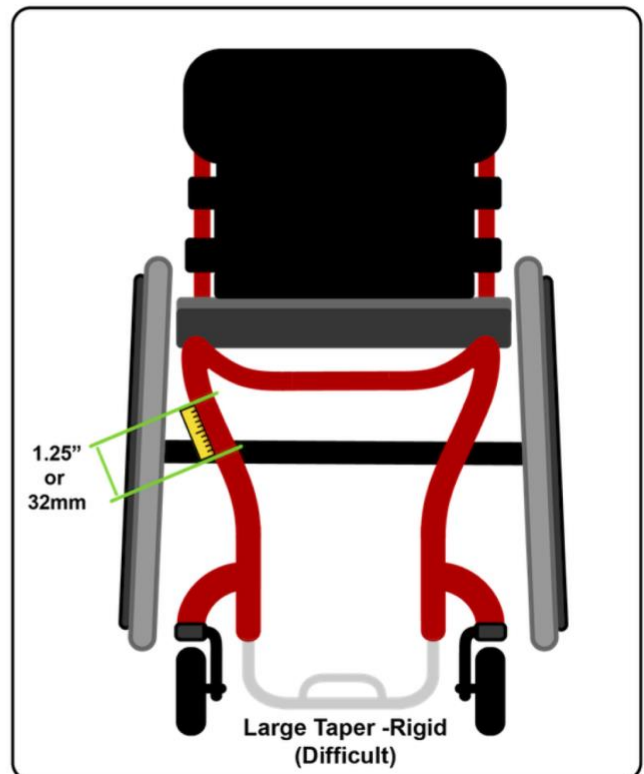
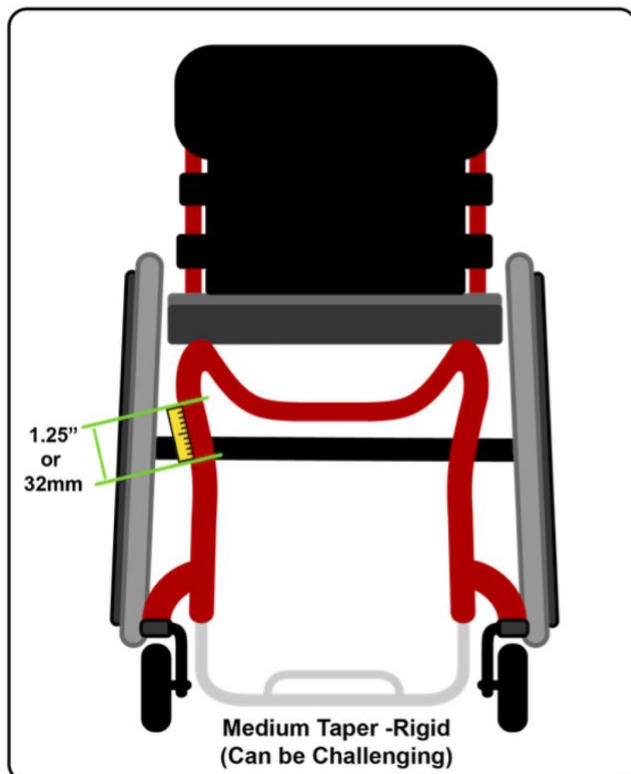
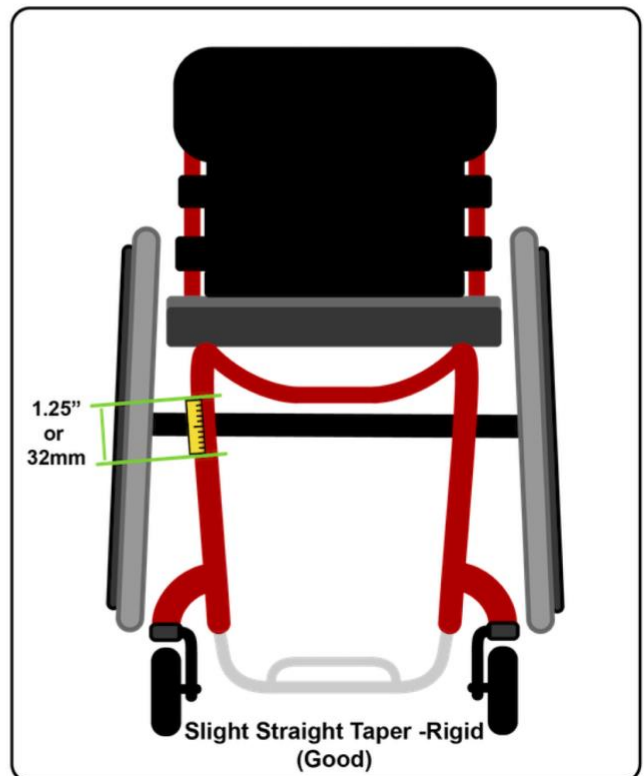
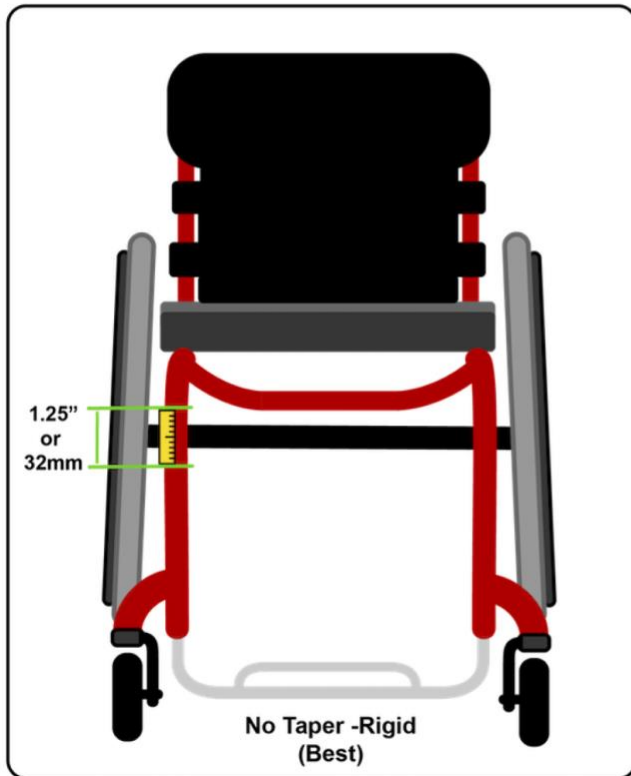

Compatibility Guide for Folding Wheelchairs

All of our devices require about 1.25 in -or- 32 mm of clearance on the upper frame tubing. Ideally this clearance should be above the area where the removable footrests attach too.

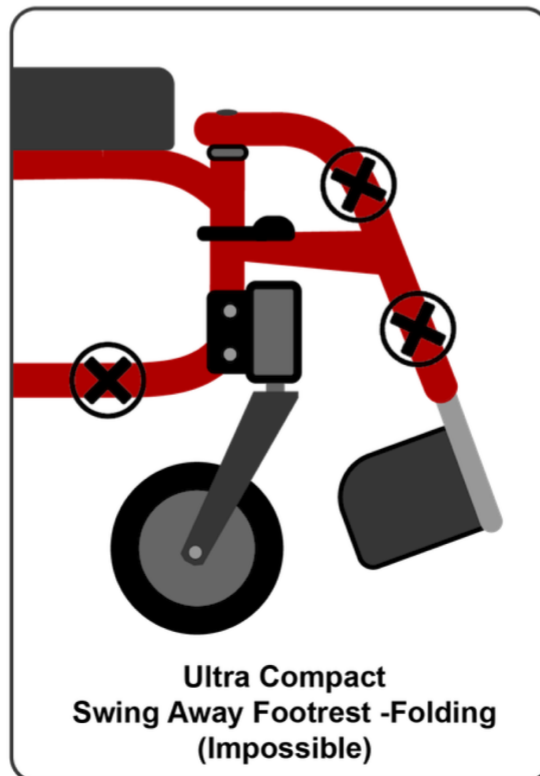
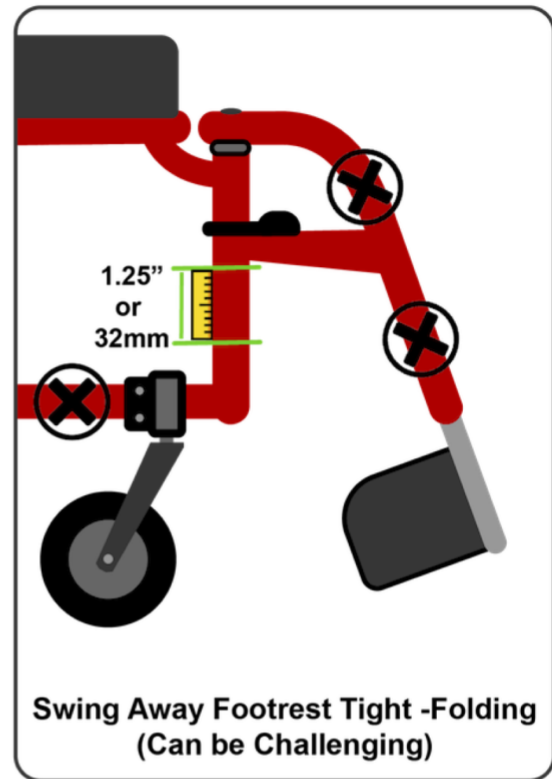
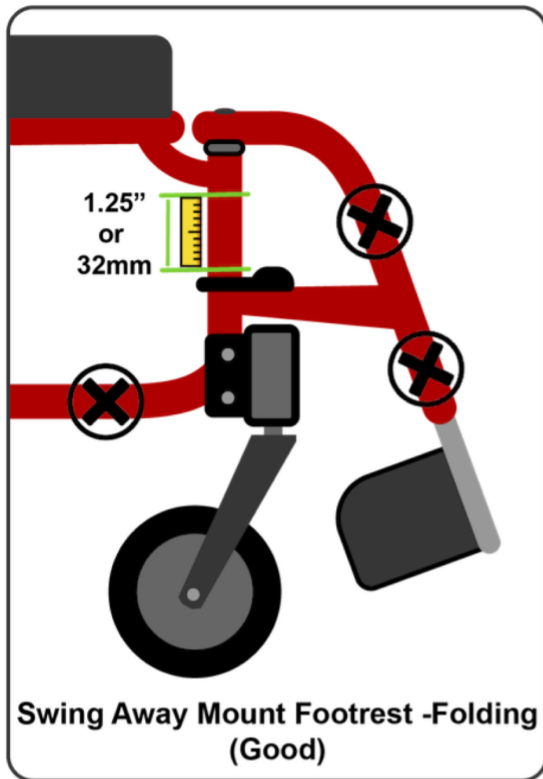

2. Installing the Firefly

Firefly™ 2.5 Component Names



The optimal installation angle for your wheelchair attachment



Good:

- 1) The chair clamps mounted high on straight tubing
- 2) Tire is as close to the foot rest while still allowing ample foot clearance from the tire while steering
- 3) The handlebar is high enough to clear the knees and allow body torso clearance when steering

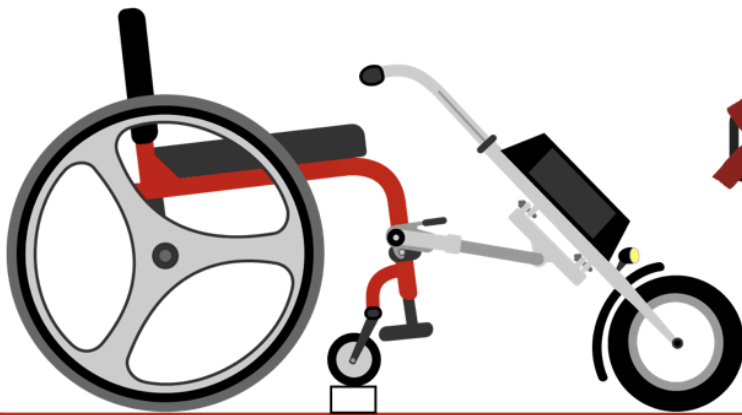

Good:

- 1) In some cases this angle is the only way to mount onto smaller width chairs meant for smaller riders or some folding chairs

Bad:

- 1) The chair clamps are mounted too low
- 2) Lost traction on the front wheel
- 3) Not enough clearance to clear the knees and or body torso when steering

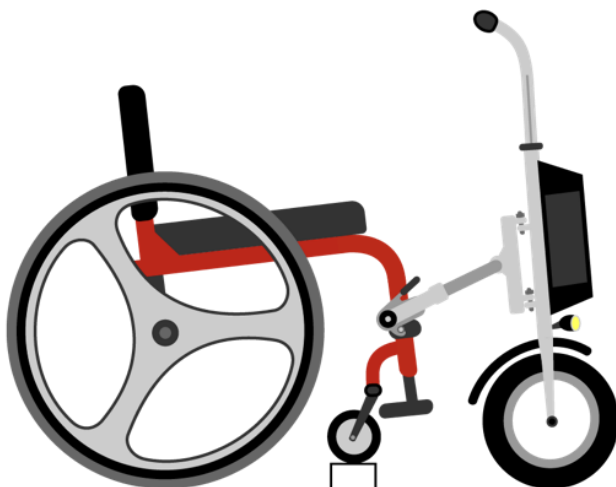

Bad:

- 1) The chair clamps are mounted too low
- 2) The tire is too close to the foot rest and will not allow foot clearance while steering
- 3) Lost traction on the front wheel, ineffective steering
- 4) The handlebar is pushed too far forward and the rider will have to lean forward while riding all the time

How to install the kickstands for the Firefly™ 2.5

There are 2 possible ways to mount the kickstand. The most common is to position the rounded faceplate out, screws on the inside with the bend facing back “A”.

The alternative position is the same clamping method as above but if the kickstand touches your front casters, change the bend direction to face away from your chair “B”.

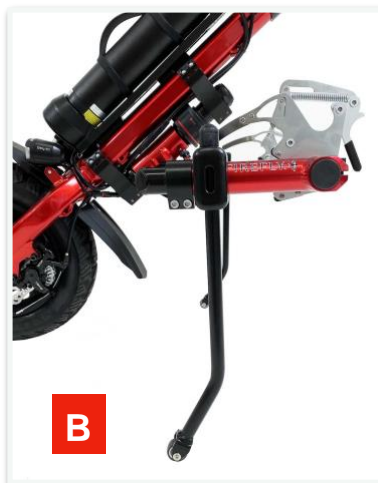
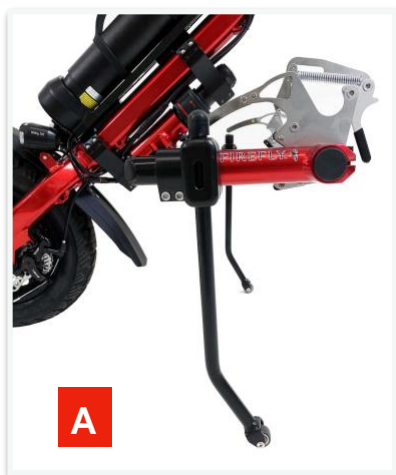

Push the kickstand clamp up against the coupler clamp “C”. Tighten the screws loosely at first using your 4mm hex wrench. Fully tighten down the screws in a diagonal configuration. If the clamp pulls too close on one side, back off that screw and cinch down the remaining screws with more tension.



*(Tighten down the screws in a diagonal configuration #1-4, **do not over tighten the screws to avoid damaging them.** Finish w/ the set screw last #5.)*



(Make sure the wheels are straight so they easily roll forward and backwards)

3. Controls

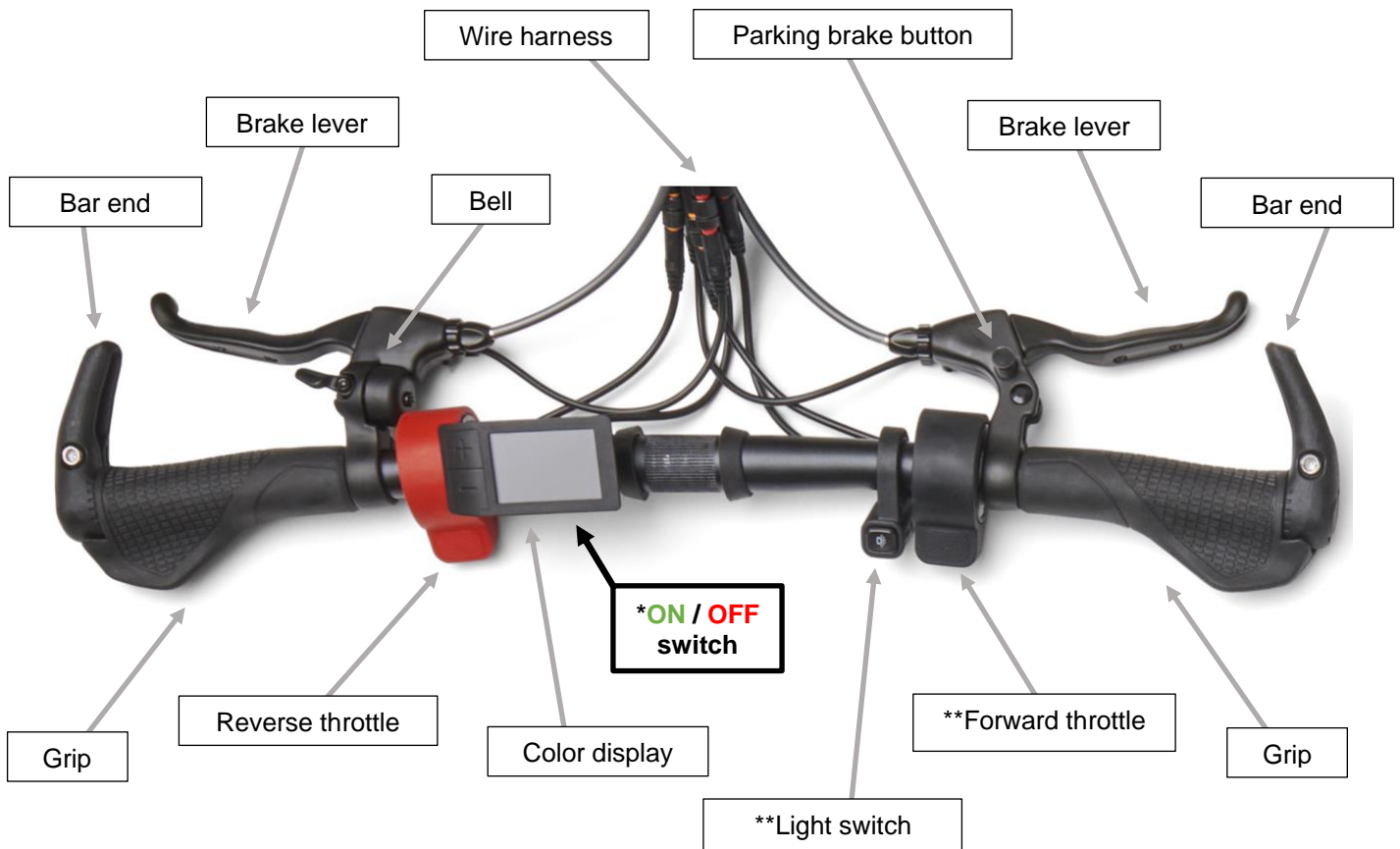

****To turn on the Firefly™ 2.5:*** press the power switch on top of the battery until the battery's LED light display turns on. Then press and hold the color display power switch for 3~5 seconds. When you see the Rio mobility logo - the unit is now powered up.

*****To activate the headlight:*** locate the light switch near the right brake lever. Press "down" and latch the light switch to turn ON the headlight. Do the same in reverse to turn OFF.

4. Docking and Transfers

Docking

The Firefly™ 2.5 is equipped with new safety features to help make docking and transferring in and out of the chair easier for you. To start the attach the Firefly™ 2.5 follow these steps.

- 1) Start by locking the headset lock. To do this twist the headset “clockwise” with your hands until you hear a click noise. You will see the safety line go from green to red (shown on next page.) The red-line means the headset is now in the “locked position.” Green-line means the headset is able to turn freely.
- 2) Your dual kickstands have been equipped with small wheels. These wheels will allow you to position the Firefly™ 2.5 into place and reduce the amount you need to lean over to bring the Firefly™ 2.5 up to docking height.
- 3) Apply the Firefly™ 2.5 parking brake lock button located on the brake lever and also apply the wheel locks on your chair.
- 4) Lift the unit by the handlebars. Gently position the coupler plate hook catches onto the rear/ back, catch pins on your chair clamps.
- 5) Gently rock the handlebar forward with one hand until your chair’s casters lift off the ground.
- 6) Now, while holding this position, take your freehand and push the coupler plate levers forward and lock them into the down position.
- 7) Check to see the coupler plate’s green-line is visible denoting the coupler plates are now locked safely on your chair.
- 8) Unlock the headset by turning it counter clockwise, you will see the red-line disappear the green-line appear. Test you can turn the handlebars side to side, you are now ready to ride!

Transferring

You **MUST** detach the handcycle in reverse before transferring. **DO NOT** attempt to transfer into or out of your chair with the Firefly™ 2.5 attached.

Headset free
(green line on top)



Headset locked
(red line on bottom)



Open coupler plate
(No green line shown)



Locked coupler plate
(green line shown)

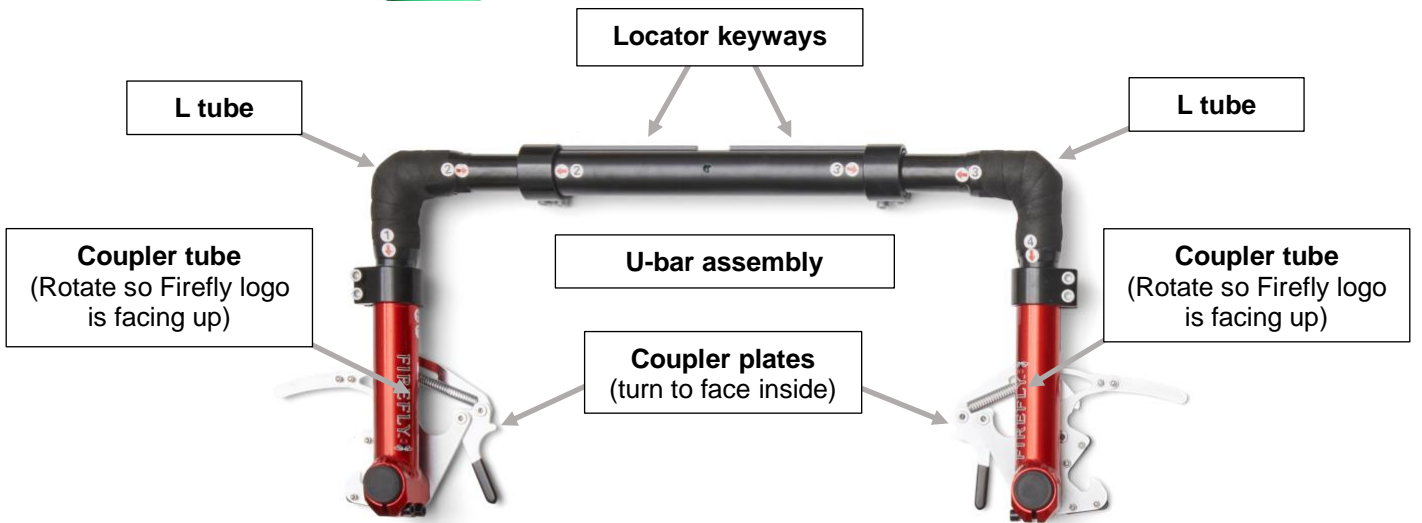

5. Maintenance

Inspection / Maintenance Item	Initially	Weekly	6 Months
Check and Tighten Hardware	X	X	
Tighten Headset Compression Nut			X
Brake Pad Wear and Adjustment			X

All hex/ Allen head screws must be tightened using a torque limiter wrench (included in your accessories box).

NOTE: Do not attempt to adjust any Safety Torx screws (the star pattern screws with a pin the middle.) These particular clamp screws have been adjusted at the factory and should not need any additional adjustment. If you think the Safety Torx screws need adjustment, please consult with your local dealer first.

Only use the included smart charger when charging your battery. **Partially recharge the battery at least every two months if it is not being used or risk a permanent decrease in capacity. Consult the battery maintenance guideline sheet included with in your charger box.**

Operation and storage temperatures must not exceed 0 - 100 F (-20 - 40 C).

The Firefly is water-resistant, not waterproof. A light drizzle **IS NOT DETRIMENTAL** but it is recommended to cover the battery and controller with a plastic bag if you're caught in a heavy rain.

Clean the handcycle with a damp cloth. Do not soak or spray with water or use detergent. Lubricate as necessary after cleaning.

Immediately replace any damaged, missing, or badly worn parts with manufacturer or approved parts. Please contact your dealer

We recommend keeping the box your Firefly™ 2.5 was shipped in: it makes a handy container for storage of your handcycle, your handcycle accessories, the included tools, and the manual for storage and travel. It can also be used to ship the unit to the factory in case of maintenance or warranty repairs.

6. Troubleshooting

When climbing a hill, the front wheel slips.

The front wheel is too far forward of your center of gravity. Please adjust the handcycle so that the front wheel is as close as possible to the footrest without interfering while driving straight or turning. If possible, you may also want to move the rear axles of your wheelchair further back. When climbing hills, leaning forward in your chair may be necessary.

Check that the front caster wheels are at least 5 cm/ 2 inches off the ground when the handcycle is installed.

The Firefly™ 2.5 won't turn on?

Make sure that the battery is fully charged. **Your battery is equipped with dual sleep mode;** for inactivity of about 10 minutes, first cycle the battery switch located on top of the battery then cycle the display's power button to wake up. For long term storage awakening, charge the battery for at least 3~5 hours to wake it up. Make sure your charger light turns from red to green.

Display Error Codes (Shown on bottom of your display screen after start up)

01E Display Signal error:

Check the handlebar display wire connector. Contact your dealer if the problem persists.

02E Controller Protection:

Check all wire connections. Contact your dealer if the problem persists.

03E Motor Phase Power Abnormality:

Check motor connector, make sure the motor wire is not damaged. Contact your dealer if problem persists.

04E Low battery:

Reseat your battery, press the battery switch and charge your battery completely. Contact your dealer if problem persists.

05E Brake switch error:

Check brake wire connectors. Test each brake function illuminates the brake switch symbol "(O)" on the bottom left side of the display. Contact your dealer if problem persists.

06E Throttle error:

Check throttle wire connectors, make sure your throttle spring is not stuck. Try reversing the throttles to find which throttle is bad. Contact your dealer if problem persists.

07E Motor Hall Sensor Abnormality:

Check motor connector, make sure the motor wire is not damaged. Contact your dealer if problem persists.

7. Safety

Safety Checklist

- A helmet and safety belt are recommended.
- **ALWAYS** engage the wheel locks on your wheelchair before attaching or detaching the handcycle, also engage the Firefly right brake handle parking button.
- **ALWAYS** check to make sure that your latches are fully engaged before operating your handcycle. Make sure the green indicator on the inner part of the coupler latch is visible.
- Check to make sure all nuts and bolts are tight and all latches are secured.
- Make sure the hand brakes work properly before riding your handcycle.
- Do not add any parts or accessories not authorized by Rio Mobility to your handcycle. Any addition could be unsafe and will void your warranty.

Before You Ride

Make sure that your Firefly™ 2.5 is installed, adjusted, and maintained properly. Do not use the Firefly™ until you and your health care professional determine that you have the ability to use it safely in an uncontrolled environment.

Use your wheelchair as described in your wheelchair manual and use the Firefly™ 2.5 in the same safe manner that you would a wheelchair with push-rims. Follow all additional warnings and instructions for the Firefly™ 2.5 in this manual.

Outdoor Use

Always watch out for traffic and pedestrians when riding on the road and sidewalk and follow all traffic regulations. Follow any and all local regulations that apply to this device.

Always mind your speed, especially when turning. You should have full control of your wheelchair at all times. Do not exceed the maximum allowable speed recommended by your wheelchair manufacturer.

Three-wheeled vehicles are less stable in turns compared to wheelchairs alone, so be careful to keep all three wheels on the ground and moderate your speed when approaching curves.

Be careful when reaching and leaning left or right from your wheelchair with your handcycle attached — the longer wheelbase makes it less stable in sideways leans than your regular wheelchair. Narrow wheelchairs are less stable in general, so be extra careful if your wheelchair is particularly narrow.

Obstacles

Be careful going over bumps and curbs over 2 inches (50mm) high. Your front casters may contact these surfaces, causing a loss of control. Use your push-rims to get over bumps, **NOT** the handcycle. You should approach bumps and curbs straight on and at low speed to avoid injury or damage to your wheelchair. Be aware of road surfaces, especially on inclines. Watch out for water, ice, and oil film.

General Notes & Precautions

Mind your fingers and hands when using your handcycle.
Keep children away from your handcycle to avoid possible injury to both you and the child.

Do not carry anything that obstructs your view or interferes with the handlebar operation.

Do not put weight on the frame (objects or people).
This handcycle is meant for everyday recreational or general sporting use and is not intended for use in competition.

Rio Mobility is not responsible for any damage or injury due to misuse of your handcycle.

8. Limited Warranty

Rio Mobility warrants the Firefly™ 2.5 for one (1) year from the date of initial consumer purchase. This warranty covers any **MANUFACTURING** defects in materials and workmanship.

Rio Mobility warrants the lithium Ion battery for three (3) months from the date of initial purchase. This covers any **MANUFACTURING** defects in materials and workmanship.

THE WARRANTY DOES NOT COVER THE FOLLOWING; DAMAGE TO CONNECTORS, CONNECTOR PINS, CABLES OR WIRES. PULLED OR SEVERED MOTOR WIRES. DROPPED CHARGERS & BATTERIES. PHYSICAL DAMAGE AFTER RECEIPT OF PRODUCT.

If you see or suspect any damage or defects report the problem upon receipt of the product. Failing to comply with the battery care instructions risks voiding your warranty.

This warranty is only available for the original owner or purchaser and is non-transferable.

Limitations

This warranty is **VOID** if:

- **Assembly and installation are not performed according to the instructions**
- **Preventative and routine maintenance has not been performed**
- **The serial number is removed or altered**
- **The hub, controller or battery are opened, altered or disassembled**
- **The handcycle is used in any competitive event**
- **The handcycle is used in stunt riding, jumping, or similar activity**
- **The handcycle is submerged in or sprayed with water; includes accidental exposure such as rain (applies mainly to electrical parts)**
- **The handcycle is used in a manner contrary to the instructions outlined in the Owner's Manual**
- **Any modifications are made to the device**
- **You accidentally run into objects and obstructions**

Please contact your dealer for installation, service, or warranty needs.