

F-003 Facial steamer



Please Read Before Use

Thank you very much for using your products, to ensure safety and effectiveness, please read the instruction thoroughly before use or look for professional advices. We are not responsible for incidents caused by not operating the product according to these instructions.

Instructions

1. Open the lid, add water until reaching the marked level on the container. Do not fill above the maximum level.

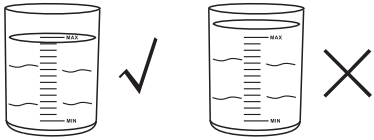

2. Plug into power source.

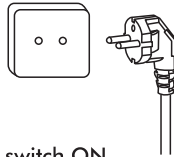

3. Put the "Vapour" switch ON.
 - Vapour light will switch on.
 - Heating components will start working
4. Put the "OZONE" switch ON.
 - OZONE light switch be on.
 - OZONE components will start working.
 - Scent of OZONE will occur at this time.

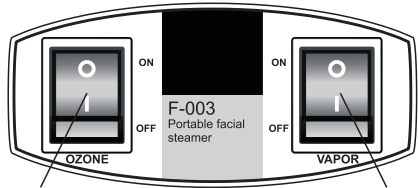

Switch for ozone

Switch for vapor

5. Water level in the container will become lower when the machine is working. When the water level reach the minimum level, turn off the machine completely before filling more water to the container.
6. The machine will alarm with beeping sound when the water level reach the minimum level, to disarm the alarm, please turn off the "VAPOUR" switch.

Attention

1. Please avoid spilling water on the machine, it might cause leakage of electricity and short circuit. Fill in water after taking off the lid. (As image below)

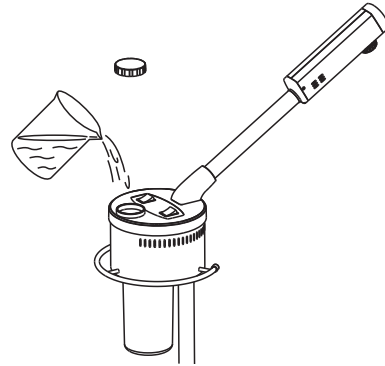

2. Make sure the water level is above minimum level before turning on the machine.
3. Make sure all switches are OFF before turning on the machine.
4. After using the machine, please turn all switches to "OFF".
5. The machine has to be placed on support component horizontally, move the machine steadily while in use.
6. When using the vapour function, the support component must be under the water container properly.

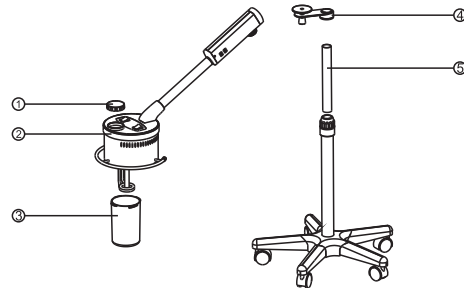

1. Lid
2. Machine Body
3. Water Container

4. Support component
5. 5 pointed roller.

Warning

1. Only fill in tap water or purified water. DO NOT add any essence oil, herbal essence or any other viscous substance, causing damage to the machine.
2. DO NOT let the steaming vapour spray on user's face directly, causing skin burning.
3. Do not store or use the machine in high temperature environment. For example: bathroom and outdoors.
4. Do not use the machine under direct sunlight.
5. Using the machine without water in the container will void the warranty.
6. Do not touch the water container while in use.
7. Please consult the manufacturer or professionals if you suspect any damage on the power cord.
8. Please contact local reseller if in doubts or if you found any abnormal situation. DO NOT

Installation

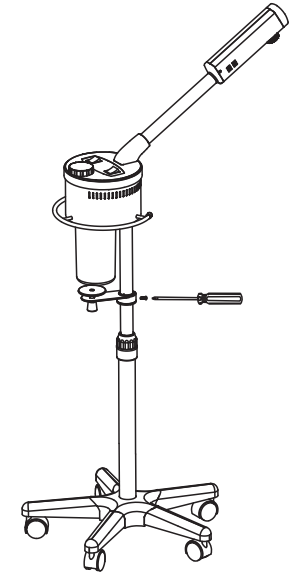
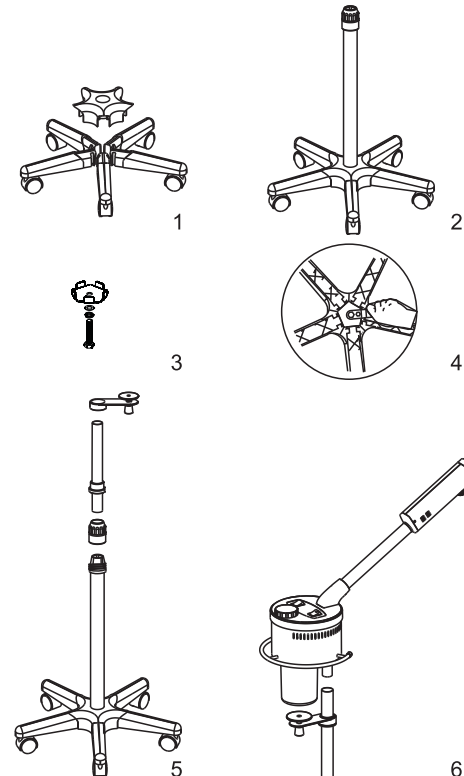

7

Maintenance

1. Please clean the water scale on the heating component weekly. Clean the vapour dispenser daily.
2. Watch out for the water level when in use.
3. Please clean any residues regularly after use.

Troubleshooting

1. Vapour will not dispense properly, often become water droplets if there are other substance in the water container, please wash the water container and heating component with vinegar and rinse with water. Contact reseller if this situation reoccur.
2. It is normal that using tap water will form water scale after a period of time. Vinegar can help soften water scale.
3. When switching on OZONE after VAPOUR is switched on for 6 minutes, a more condensed vapour will come out. If OZONE failed to work, It could be failure of the ultra-violet tube, please contact reseller for inspection and repair.

In the box

Item	Machine Body	Water Container	5 pointed Roller	Screws	Seals	Support Component	Screwdriver
Amt.	1 pcs	1 pcs	1 set	1 pack	1 pcs	1 set	1 pcs