

DeRoyal has it Covered



Equipment Covers & Drapes

 DeRoyal®

Equipment Drapes

DeRoyal's equipment drapes and covers are designed to promote ease of use and provide excellent quality at a managed care price. Our equipment drapes ensure sterility and protect equipment during procedures, and are available in a wide variety of shapes, sizes, and styles. In addition, all of DeRoyal's equipment covers have a special slip coating for ease of application. As such, DeRoyal is your place for "one-stop-shopping" for all your equipment cover needs, offering the best fit, the best quality, and the best pricing.

When it comes to your equipment drape needs... DeRoyal has it covered.

CONTENTS

Product Listing	Page
C-ARM DRAPES	3
MICROSCOPE DRAPES	
Universal	4
Leica	5
Zeiss® OPMI	6
Zeiss® MD	7
CAMERA DRAPES	
Endoscopic and Laser Arm	8
Closed Camera System	9
CASSETTE DRAPES	10-11
BAND BAGS	12
AUXILLARY DRAPES	
Isolation Drape	13
Foot-Switch Cover	13
Slush Drape	14
Case Cart Cover	14
TRAUMA DRAPES	15

DeRoyal has it covered

C-ARM DRAPES



C-Arm Drape

- Large, one-piece clear poly cover for complete coverage of C-Arm
- White poly adhesive straps secure drape in place
- Wide range of sizes available
- Packaged with telescoping fold
- Adhesive straps included to secure excess drape material
- Latex free

Product #	Description	Quantity
-----------	-------------	----------

30-0202	C-Arm Drape, 36" x 28" Rectangular Band Bag Style	20/Cs
---------	--	-------

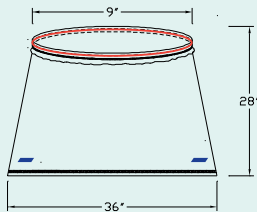

30-0204	C-Arm Drape, 41" x 90" Mobile X-Ray Drape w/Extra Length	20/Cs
---------	---	-------

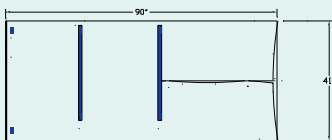

30-0201	C-Arm Drape, 41" x 74" Mobile X-Ray Drape	20/Cs
---------	--	-------

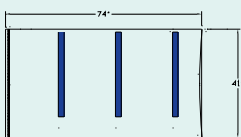

30-0209	C-Arm Drape, 41" x 140" Mobile X-Ray Drape	10/Cs
---------	---	-------

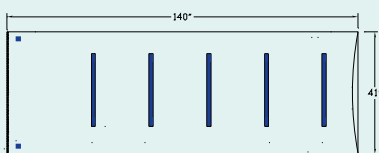

30-2951	C-Arm Drape, Mobile X-Ray Drape w/Velcro & Adhesive Strips, C-shaped	20/Cs
---------	---	-------

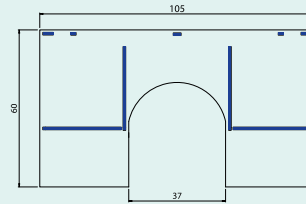

30-8838M	C-Arm Drape, 41" x 59" Mini for Fluoroscanner	20/Cs
----------	--	-------

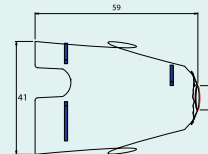

30-106M	C-Arm Drape, 41" x 84" Mini for OEC 6600	20/Cs
---------	---	-------

30-006M	C-Arm Drape, 41" x 84" Pack w/Keyboard & Footswitch Covers	20/Cs
---------	---	-------

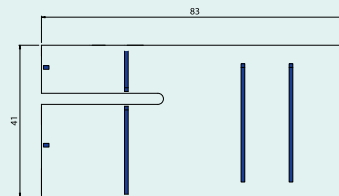

■ Rubberband
 ■ Tape

Equipment Drapes

MICROSCOPE DRAPES



Microscope Drapes

- Complete protection for costly equipment
- A variety of configurations for widely used brands - Zeiss OPMI, Zeiss MD and Leica
- Available for any size or combination of attachments
- Ease of draping for protection of sensitive instruments
- Maintains sterility of microscope during procedures
- Includes straps for securing excess drape material
- Clear, easy to understand instructions attached to each drape
- Latex free

Universal

Product # **Description** **Quantity**

30-2902 Microscope Laser Drape
2 Piece Kit, 41" x 105", 9" x 80" 10/Cs

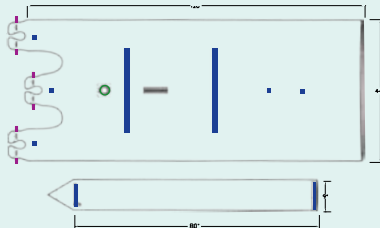

30-2910 Microscope Laser Drape
20" x 56" 10/Cs

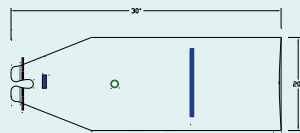

30-0720 Microscope Laser Drape
20" x 65" 10/Cs

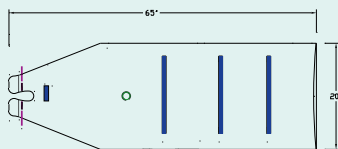

30-2903 Microscope Laser Drape
w/Laser Arm Attachment, 41" x 120" 10/Cs

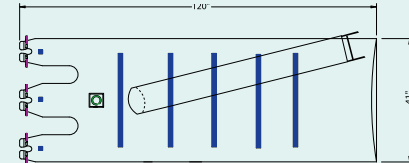

30-0751 Microscope Laser Drape
w/Laser Arm Attachment, 44" x 120" 10/Cs

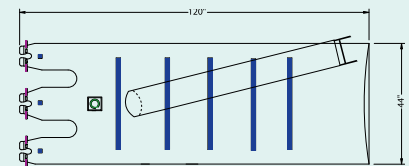

■ Tape ■ Lens ■ Hook & Loop

DeRoyal has it covered



Leica
(70mm O. D. Lens)

Product #	Description	Quantity
30-0704	Microscope Drape, Leica M600, 44" x 120"	10/Cs

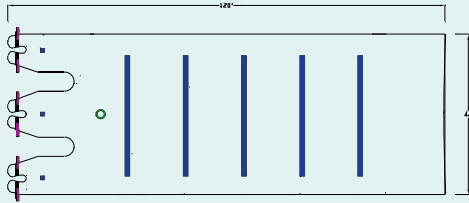

30-3598	Microscope Drape, Leica M680, 46" x 120"	10/Cs
---------	--	-------

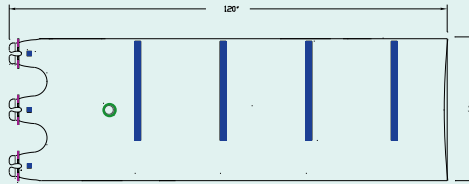

30-2955	Microscope Drape, Leica, 41" x 120"	10/Cs
---------	-------------------------------------	-------

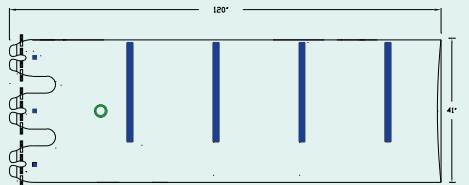

30-2952	Microscope Drape, Leica, 41" x 64"	10/Cs
---------	------------------------------------	-------

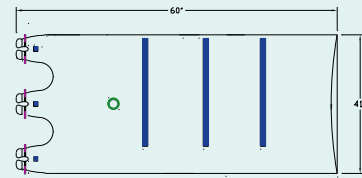

30-0705	Microscope Drape, Leica, 54" x 120"	10/Cs
---------	-------------------------------------	-------

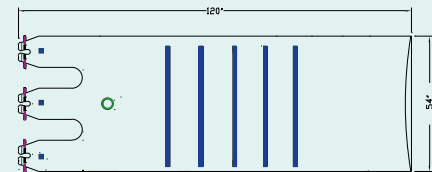

30-0700	Microscope Drape, Leica, 54" x 150"	10/Cs
---------	-------------------------------------	-------

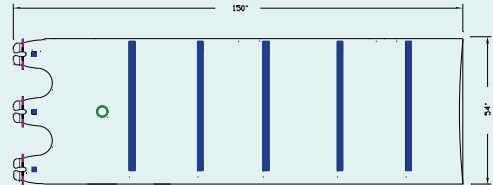

Tape
 Lens
 Hook & Loop

Equipment Drapes



Zeiss® OPMI
(48mm O.D. Lens)

Product #	Description	Quantity
30-4931	Microscope Drape, Zeiss OPMI 41" top x 19" bottom x 56"	10/Cs

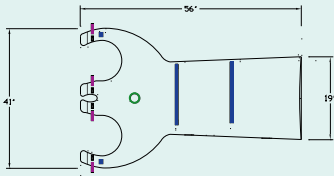

30-0713	Microscope Drape, Zeiss OPMI 41" x 120"	10/Cs
---------	--	-------

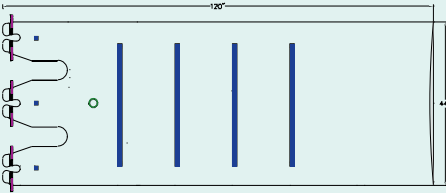

30-5957	Microscope Drape, Zeiss OPMI 41" x 105"	10/Cs
---------	--	-------

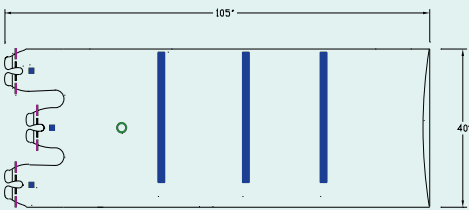

30-0715	Microscope Drape, Zeiss OPMI 41" x 64"	10/Cs
---------	---	-------

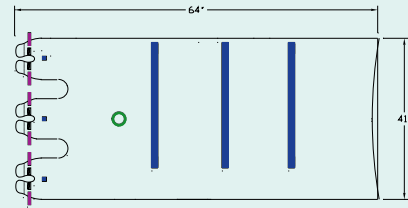

30-4957	Microscope Drape, Zeiss OPMI 41" x 64"	10/Cs
---------	---	-------

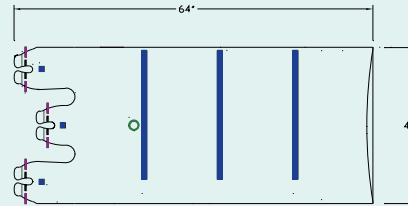

30-0714	Microscope Drape, Zeiss OPMI, 44" x 80"	10/Cs
---------	--	-------

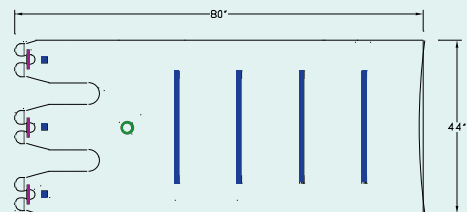

■ Tape
 ■ Lens
 ■ Hook & Loop

DeRoyal has it covered



Zeiss® MD
(65mm O.D. Lens)

■ Tape ■ Lens ■ Hook & Loop

Product #	Description	Quantity
30-0718	Microscope Drape, Zeiss MD, 44" x 80"	10/Cs

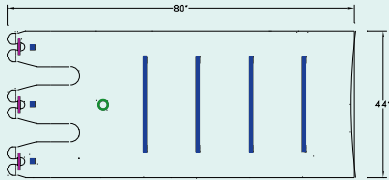

30-4840	Microscope Drape, Zeiss MD, 46" x 105"	10/Cs
---------	--	-------

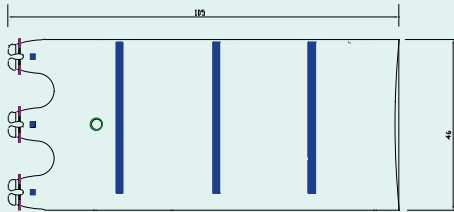

30-5857	Microscope Drape, Zeiss MD, 46" x 105"	10/Cs
---------	--	-------

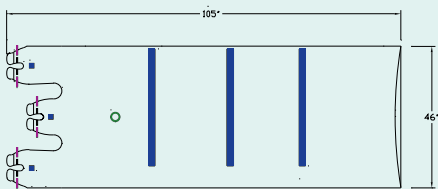

30-4838	Microscope Drape, Zeiss MD, 46" x 120"	10/Cs
---------	--	-------

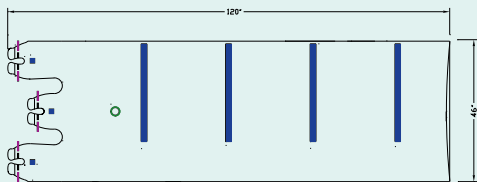

30-4841	Microscope Drape, Zeiss MD, 46" x 65"	20/Cs
---------	---------------------------------------	-------

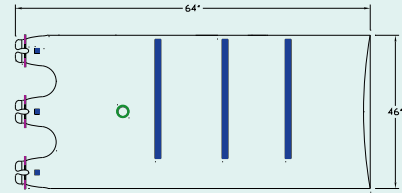

30-4862	Microscope Drape, Zeiss MD, 46" x 80"	10/Cs
---------	---------------------------------------	-------

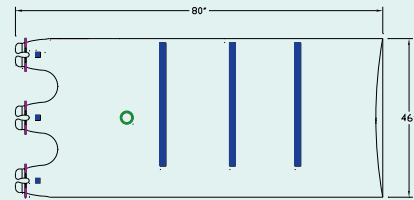

30-0712	Microscope Drape, Zeiss MD, 46" x 151"	10/Cs
---------	--	-------

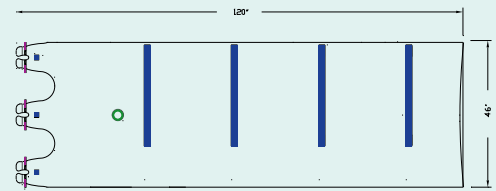

30-4842	Microscope Drape, Zeiss MD, 54" x 105"	10/Cs
---------	--	-------

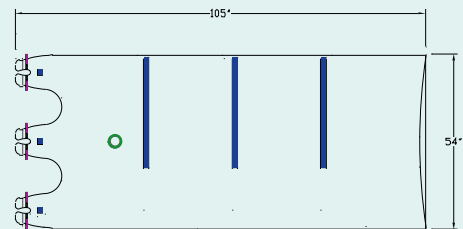

Equipment Drapes

CAMERA DRAPES



Endoscopic Camera & Laser Arm Drape

- For use in laparoscopic, arthroscopic and hysteroscopic procedures
- Provides sterile barrier
- Protects expensive equipment by eliminating need to sterilize camera
- Neatly fits around endoscope attached to camera
- Telescopic fold with cuff for easy draping and full cord coverage
- Allows visualization all the way through the drape's end
- Latex free rubber bands and adhesive strips for secure closure
- Clear elasticized fenestration for secure fit on Krayton tip version
- Latex free

Product

Description

Quantity

28-0401 Camera Drape, Laser Arm, 7" x 96"
Elastic Krayton™ Tip, 1/4" Opening

60/Cs

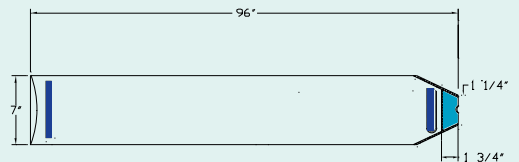

30-5946 Camera Drape, Laser Arm, 5" x 144"
Perforated Tip, 2" Opening

25/Cs

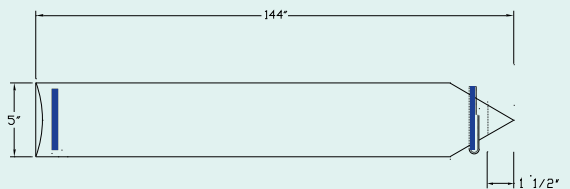

28-0402 Camera Drape, Laser Arm, 5" x 96"
Perforated Tip, 2" Opening

20/Cs

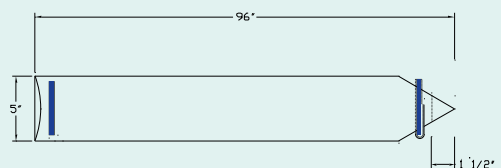

30-0901 Camera Drape, Laser Arm, 9" x 96"
Perforated Tip, 2" Opening

25/Cs

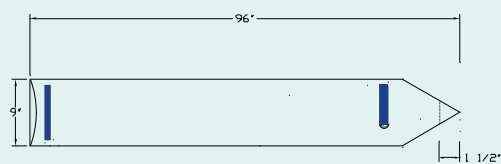

 Tape

 Krayton™

DeRoyal has it covered

CAMERA DRAPES

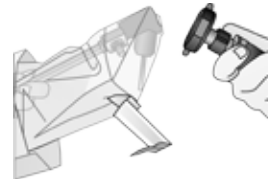

Step 1: Insert sterile endoscope into open end of drape with drape lens centered over the end of scope.



Step 2: Securely attach camera to endoscope.



Step 3: Unfold telescoping folds of drape by grasping end and pulling drape over camera and cord.



Step 4: Camera and scope are ready for use.

Closed Camera System Drape

- Protects sensitive video cameras from contamination and fluids
- Prevents contamination of sterile field by non-sterile camera when changing scopes during a procedure
- Reduces turn-around time between cases
- Saves costly repairs caused by the repeated soaking and sterilization of camera
- Optically clear lens is anti-fog coated for clarity
- Soft, pliable material around camera provides excellent tactile properties, secure fit and easy operation of scope release buttons
- Latex free

Product #	Description	Quantity
28-0403	Camera Drape, Laser Arm, Closed, 7" x 96" 3/4" Lens	60/Cs
30-2900	Camera Drape, Laser Arm, Closed, 7" x 96" 5/8" Lens	10/Cs

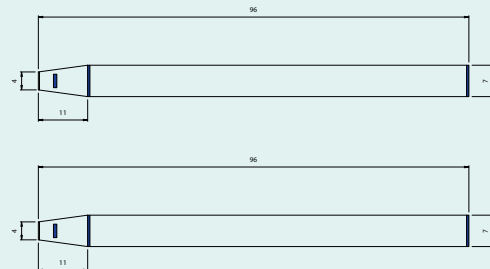

Equipment Drapes

CASSETTE DRAPES

X-Ray Cassette Covers and Liners

- Clear poly bag with wide adhesive strip for closure
- Several sizes to fit a broad range of cassette widths and lengths
- Double Cassette Drape available with unique closure to ensure sterility
- Pull-away liner reduces chance of contamination once cassette is inserted
- Latex free



Product #	Description	Quantity
30-0105	X-Ray Cassette Cover w/Adhesive Strip, 24" x 20", Standard	48/Cs
30-0101	X-Ray Cassette Cover w/Adhesive Strip, 24" x 25", Standard	20/Cs

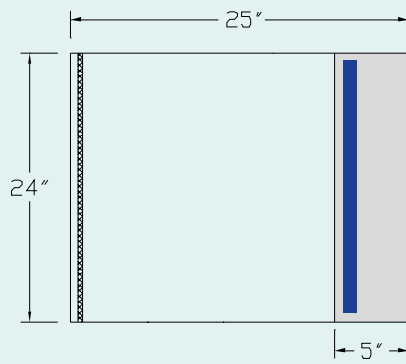
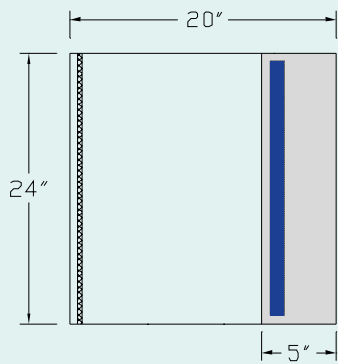

30-0102	X-Ray Cassette Cover w/X-large Cuff, 21" x 40"	20/Cs
---------	--	-------



Step 1: Grasp both corners of drape to unfold. Position hands inside cuff at each corner in accepting position.



Step 2: Spread drape apart to allow accepted cassette to gently slide to bottom of drape.



Step 3: Fully extend drape.

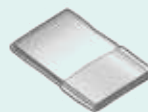

Step 4: Fold drape until cuff fits opposite end of cassette.

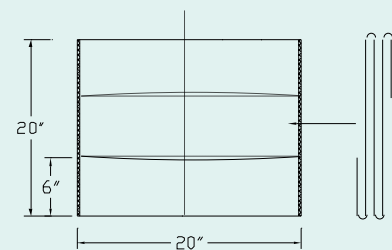

 Tape

DeRoyal has it covered

Product # 30-0103
Description X-Ray Cassette Cover w/Release Liner, 20" x 24"

Quantity 20/Cs

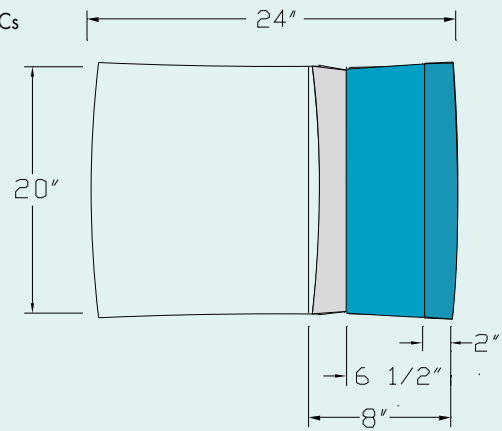

Product # 30-0104
Description X-Ray Cassette Cover w/Release Liner, 24" x 23"

Quantity 20/Cs

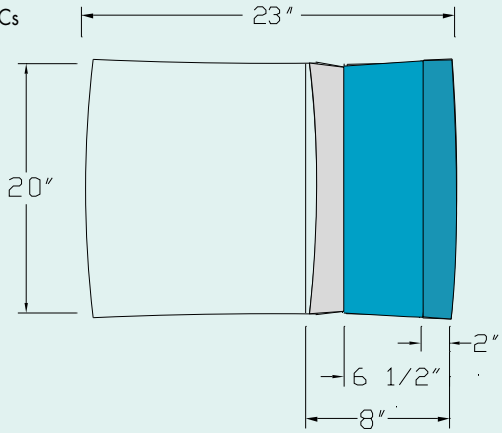

Step 1: Position hands under white corner cuffs and spread drape apart to accept cassette.



Step 2: Insert cassette into drape through blue liner.



Step 3: Carefully remove liner by grasping outer sleeve and pulling up.



Step 4: Gently slide cassette to the bottom of the drape.



Step 5: Unfold white cuff.



Step 6: Fold cuff over cassette edge to close drape.

Equipment Drapes

BAND BAGS

Flouroscope/Banded Bags

- Clear polyethylene maintains sterility in Cath labs
- Ensures sterility and protects equipment during procedures
- A wide range of sizes available
- Can be used for many applications in Surgery, Special Procedure Labs, Labor & Delivery, G.I. Labs, Radiology, Emergency Department and others
- Rectangular, square and round configurations
- Latex free



Product #	Description	Length	Width	Opening (Unstretched)	Quantity
77-103012T	Band Bag w/Rubberband & Tape	30"	12"	7"	25/Cs
77-103018T	Band Bag w/Rubberband & Tape	30"	18"	7"	25/Cs
77-103020T	Band Bag w/Rubberband & Tape	30"	20"	7"	25/Cs
77-103030T	Band Bag w/Rubberband & Tape	30"	30"	7"	25/Cs
77-103036T	Band Bag w/Rubberband & Tape	36"	30"	9"	25/Cs
77-103620T	Band Bag w/Rubberband & Tape	36"	20"	7"	25/Cs
77-103630T	Band Bag w/Rubberband & Tape	30"	36"	9"	25/Cs
77-103636T	Band Bag w/Rubberband & Tape	36"	36"	9"	25/Cs
77-103640T	Band Bag w/Rubberband & Tape	36"	48"	9"	25/Cs
77-103654T	Band Bag w/Rubberband & Tape	36"	54"	9"	25/Cs
77-104030T	Band Bag w/Rubberband & Tape	40"	30"	9"	25/Cs
77-104036T	Band Bag w/Rubberband & Tape	40"	36"	9"	25/Cs
77-104040T	Band Bag w/Rubberband & Tape	40"	40"	9"	25/Cs
77-104060T	Band Bag w/Rubberband & Tape	40"	60"	9"	25/Cs

Product #	Description	Depth	Quantity
77-100011	Band Bag, Round w/Sewn Elastic, Small	14"	25/Cs
77-100012	Band Bag, Round w/Sewn Elastic, Medium	22"	25/Cs
77-100013	Band Bag, Round w/Sewn Elastic, Large	27"	25/Cs
77-100025	Band Bag, Round w/Sewn Elastic, X-Large	50"	25/Cs

Product #	Description	Length	Width	Quantity
77-100015T	Flouroscope Drape Flat w/Tape	44"	35"	25/Cs

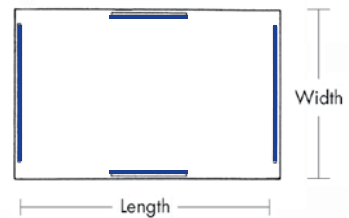
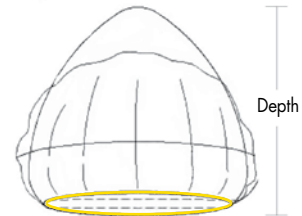
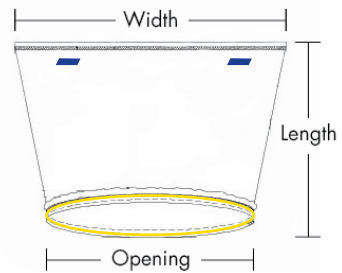

Tape
 Sewn Elastic

DeRoyal has it covered

AUXILLARY DRAPES



Isolation Drape

- Protects intestines against trauma and contamination when outside the abdominal cavity during surgery
- Useful to isolate distal portions of extremities from contamination
- Other uses include the transport of specimens and to protect equipment during procedures and storage
- High quality, soft, flexible material that is strong and puncture-resistant
- Impervious vinyl film bag allows the visualization of organs at all times
- High tensile strength and elongation properties ensures the safety of the sterile environment without tearing
- Draw string to enclose to be kept moist throughout the duration of the case
- Moisture-proof surface prevents fluid loss through evaporation
- Latex free

Product #	Description	Quantity
30-5510	Isolation Bag, Clear, 20" x 20"	40/Cs



Foot - Switch Cover

- Non-sterile poly drawstring bag with two layers to protect O.R. foot controls from fluids
- Provides clarity for surgeon when operating foot controls
- Latex free

Product #	Description	Quantity
30-0301NS	Foot Switch Cover, 16" x 18" x 3"	200/Cs

Equipment Drapes

AUXILLARY DRAPES

Slush Drape

- Maintains sterile field
- Facilitates proper slush production and consistency
- Excellent and economical for cardiac and transplant procedures
- Latex free

Product #	Description	Quantity
30-0602	Slush Drape, 54" x 54" (for use under sterile basin)	50/Cs



Case Cart Cover

- Non-sterile, 2 mil cover for critical items on case carts
- Clear poly perforated bag fits to size to keep items in place
- Latex free

Product #	Description	Quantity
32-1385NS	Case Cart Cover, Clear, 48" x 72"	100/Roll
32-1386NS	Case Cart Cover, Opaque, 48" x 72"	100/Roll



DeRoyal has it covered

TRAUMA DRAPES

Trauma Drape

- Helps keep trauma tables and stretchers free of bodily fluids
- Super absorbency
- A variety of drapes offered
- Two convenient drape kits available
- Latex free

Product #	Description	Quantity
59-0736NS	Trauma Table Drape (36" x 88")	24/Case
59-0739NS	Cover, Stretcher	50/Case
59-0744NS	Trauma Drape Pack, Duo Includes: Trauma Table Drape (36" x 88") Trauma & Turn Sheet (77" x 36")	24/Case
59-0742NS	Trauma Drape Pack, Trio Includes: Trauma Table Drape (36" x 88") Trauma & Turn Sheet (77" x 36") Trauma Table Skirt (48" x 48")	24/Case

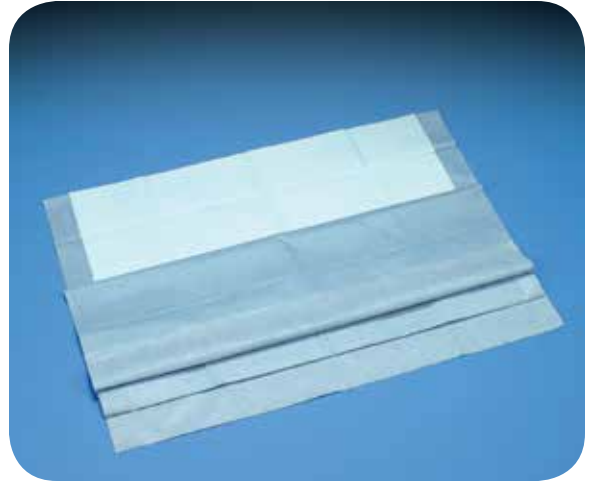

Trauma & Turn Sheet (77" x 36")



Trauma Table Drape (36" x 88")



Table Skirt

Equipment Drapes



Improving Care. Improving Business.

DeRoyal Industries, Inc.
200 DeBusk Lane
Powell, TN 37849
800.251.9864
865.938.7828
www.deroyal.com