

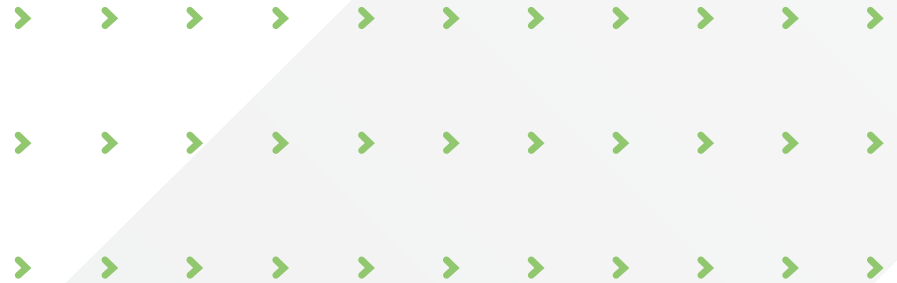

The leader  
in healthcare™

# FITRIGHT®



Continence Care Solutions & Product Catalog



## What we promise:

To provide market-leading products, support and solutions to aid you in managing incontinence, making it easier than ever before.

## What that means:

You have a true partner for incontinence solutions. We are here to help you overcome challenges and achieve operational excellence for your facility.

## How we do it:



**Market-leading innovations created by clinicians**



**Clinical support you can trust**



**Tools to help you do more with less effort**



**Vertical integration for an operationally strong facility**



---

**300,000+**  
**Medline**  
products

---

**1 million**  
**cases**  
of incontinence  
**products**  
manufactured  
in the U.S. every month\*

---

**200+**  
**clinicians**  
on staff\*

---

**45**  
**distribution**  
**centers**  
in North America

---

**99%+**  
of orders  
**shipped**  
**same day\***

---

\*Data on file.



# Your big picture partner

Medline has the resources to deliver quality-made products when you need them. Experience the peace of mind that comes with knowing we manage the entire process from the moment a product is made to the second a box arrives at your door – directly from our door to yours.



**Medline** is the largest manufacturer and distributor of medical supplies. We focus on technologies that drive both quality and cost efficiency at every point in the supply chain. So, you can trust that you're getting the best quality products and solutions for the best possible price.

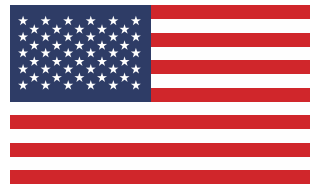

Proudly manufactured in the United States\*

**99%+**  
quality  
satisfaction  
**rate\*\***

\*Majority of products are manufactured in the U.S. Made with domestic and foreign materials.  
\*\*Data on file.



## Direct-to-customer savings

Medline sells products directly from our factory to you; assuring you Medline quality, plus better prices – because we pass the savings on to you.



## Customers come first

Our quality metrics make sure every product that goes out the door is one we would use for a friend or family member of our own.



## Tested and trusted

Our machines are equipped with state-of-the-art quality assurance technology that performs full visual inspections on each and every product. We also test performance on a set basis to ensure all of our products meet your expectations.



# 24/7 support\* to make caregivers' lives easier

Managing incontinence isn't easy. Medline is helping healthcare facilities meet the challenge with industry-leading clinical support and expertise. We offer best practice guidelines to deliver actionable recommendations that positively impact outcomes for your facility. Our goal is to make it easier for caregivers to give top-notch incontinence care and select the right products for those in their care.

## A team of trusted clinicians

We work with you to make sure your staff has the knowledge and skills to provide the best incontinence care possible.

- Product in-services, training and education
- Product use analysis and system integration
- Clinical evaluations

## The right product, the right fit

Our color-coded packaging systems make finding the right product and size simple.

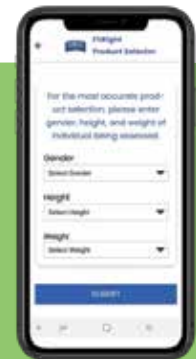

A phone app that  
makes it easy

## Sizing has never been easier

Using the FitRight Tape Measure, measure hip-to-hip across the front of the body.

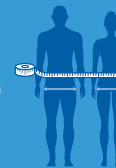

**By color:** Look for the color-coded size right on the tape.  
Example: Blue = Large brief

**By number:** Add 2" to your measurement then multiply by 2.  
Example:  
 $16" + 2" = 18" \times 2 = 36" = \text{Medium brief}$



## The FitRight Assessment Tool

As a healthcare provider, you're on a mission to deliver high-quality care with constantly changing regulations, lower reimbursements and strong pressures to cut costs.

The online FitRight Assessment Tool evaluates your facility's habits to help you increase efficiencies, reduce costs and ensure your residents are in the right product and the right size.



**Integration with your EMR system**



**Automated size and product selection**

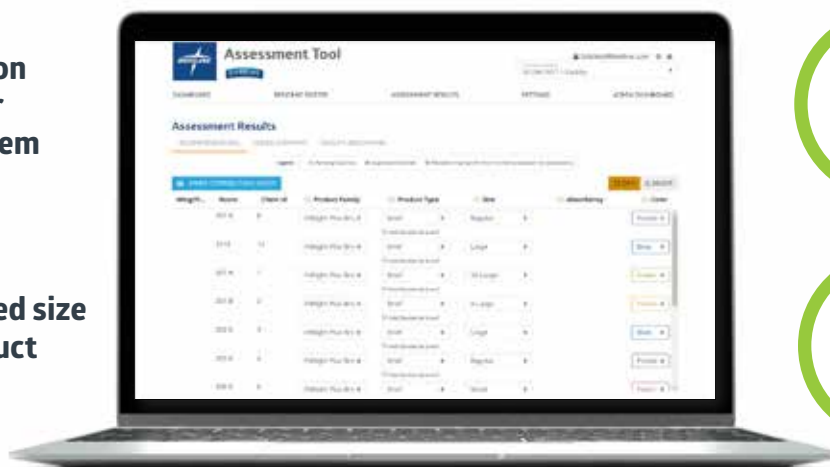

**Comprehensive metrics for cost management**



**Insights into utilization data and trends**

**and it's all free to you.**

\*Provided through Medline tools, online resources and clinical support.

# Incontinence solutions designed to improve care

Medline has developed products to meet the clinical needs of any incontinent individual, whether they live at home or in a long-term care setting. Dignity, dryness and comfort are part and parcel of every product we provide.

## A product for every need



### **Briefs**

Heavy bladder and bowel incontinence.



### **Protective Underwear**

Light daytime incontinence; extra protection at night.



### **Bladder Control & Feminine Hygiene**

Light bladder leakage and menstrual protection.



### **Liners & Pants**

Heavy bladder and bowel incontinence.



### **Underpads & Ultrasorbs®**

Open-to-air incontinence management, procedures and surface protection.



### **Baby & Youth**

Diapers and wipes for the little ones.



### **Cleansing & Skin Care**

Wipes, lotions and soaps for gentle cleaning and moisturizing.





# Technology that drives superior performance

## EasyFlex™ Stretch

Easy application for caregivers and the best possible fit for your residents.

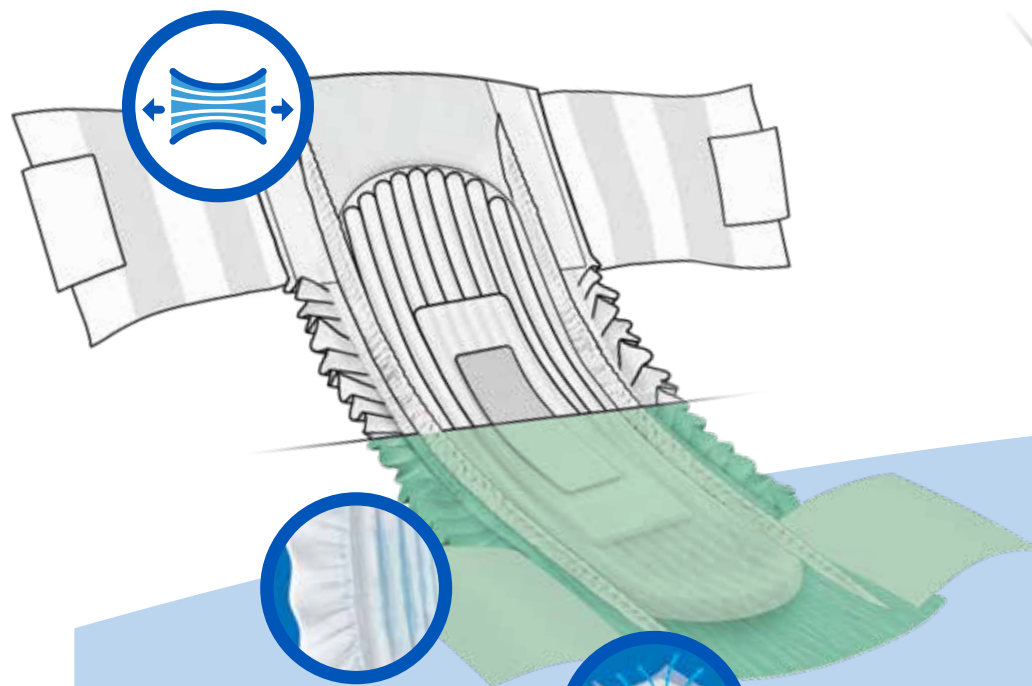
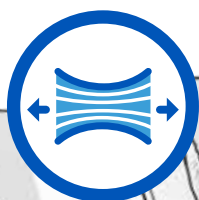

## Core Channels

Pulls liquid away faster than ever before and disperses it throughout the product to keep skin as dry as possible.



## ComfortAir™

Breathable design for improved microclimate.

## SensiSoft™ Fabric

For an individualized garment-like fit that is soft and gentle on skin.

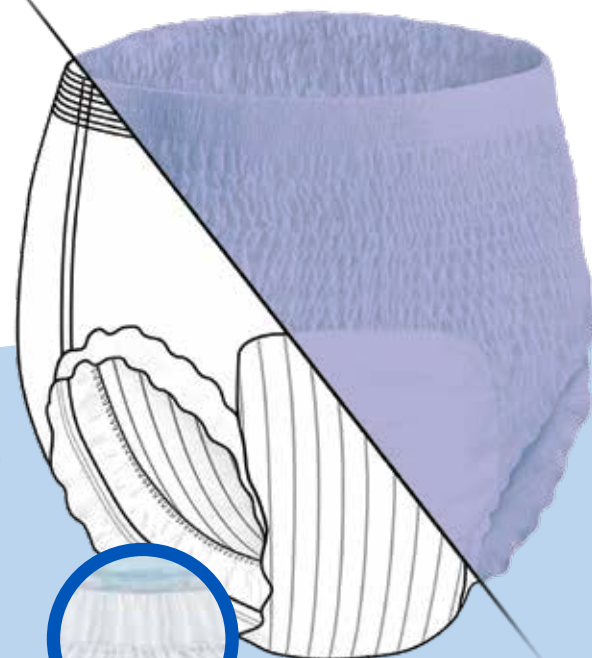

## Leak-Stop™ Guards

For those who need that extra protection.

## Extended Use™ Technology

Absorbs 5 times more liquid than ordinary products\*.

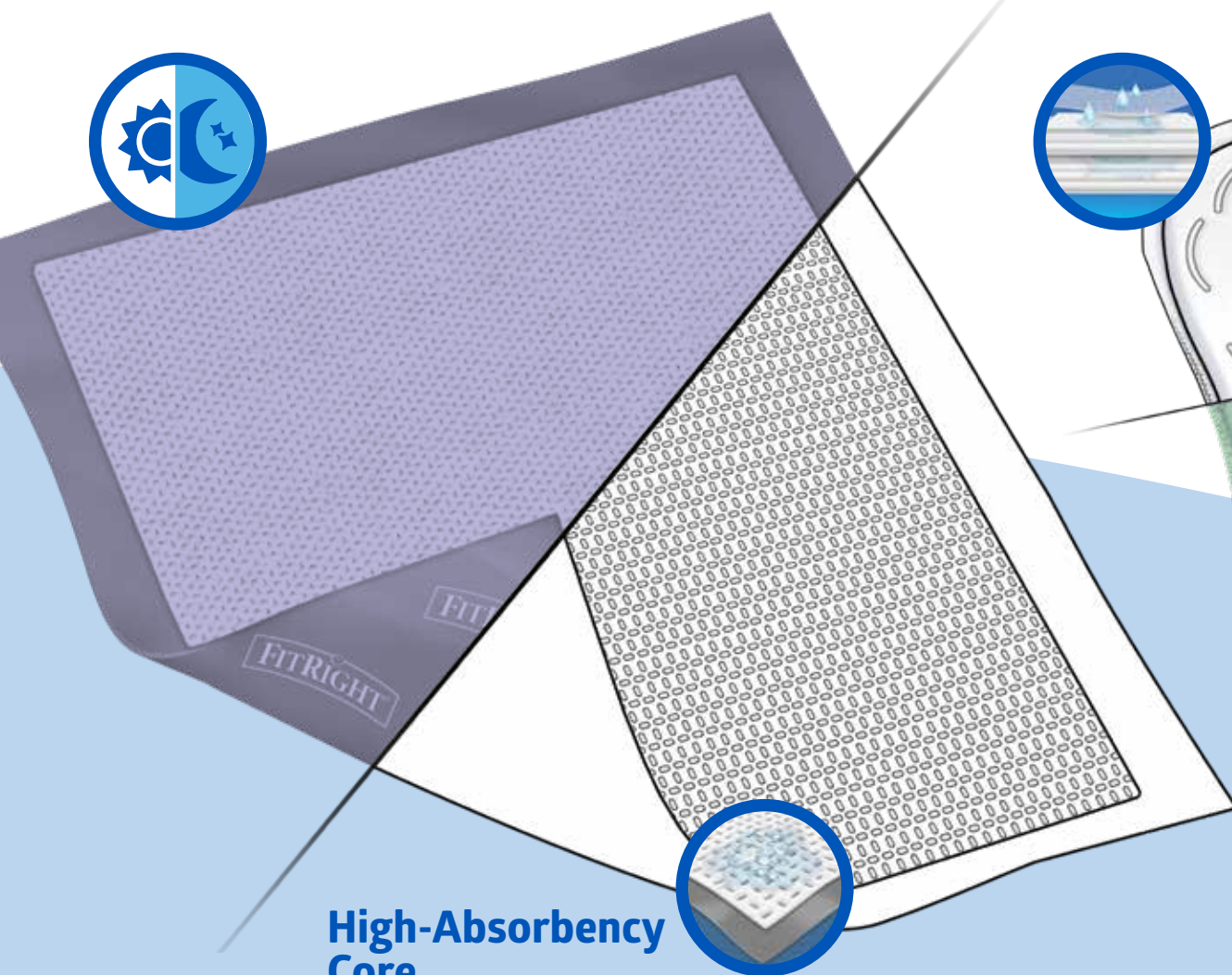
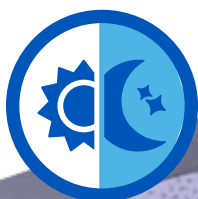

## High-Absorbency Core

Works to protect skin, save caregivers time and reduce costs.

## 4D Core™

Locks fluid in, working to keep skin cool and dry.

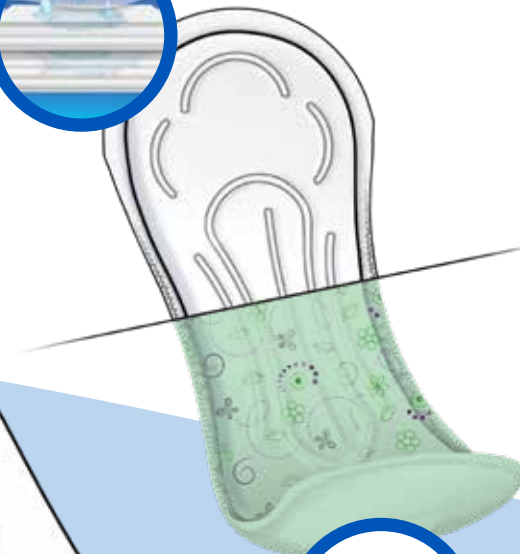

## Discreet Products

Meeting the individual needs of users.

\*Data on file.

# Uniquely designed with resident **comfort** in mind

Optimal comfort comes from market-leading innovation. That's why FitRight created the OptiFit™ Solution to improve fit, increase breathability and provide maximum protection against leakage with the utmost discretion.

## #1 brief

used in long-term care settings\*



OptiFit™ construction provides the **best possible fit**.



Improves outcomes with a **well-balanced microclimate**.



Large leg openings for **ideal air flow**.

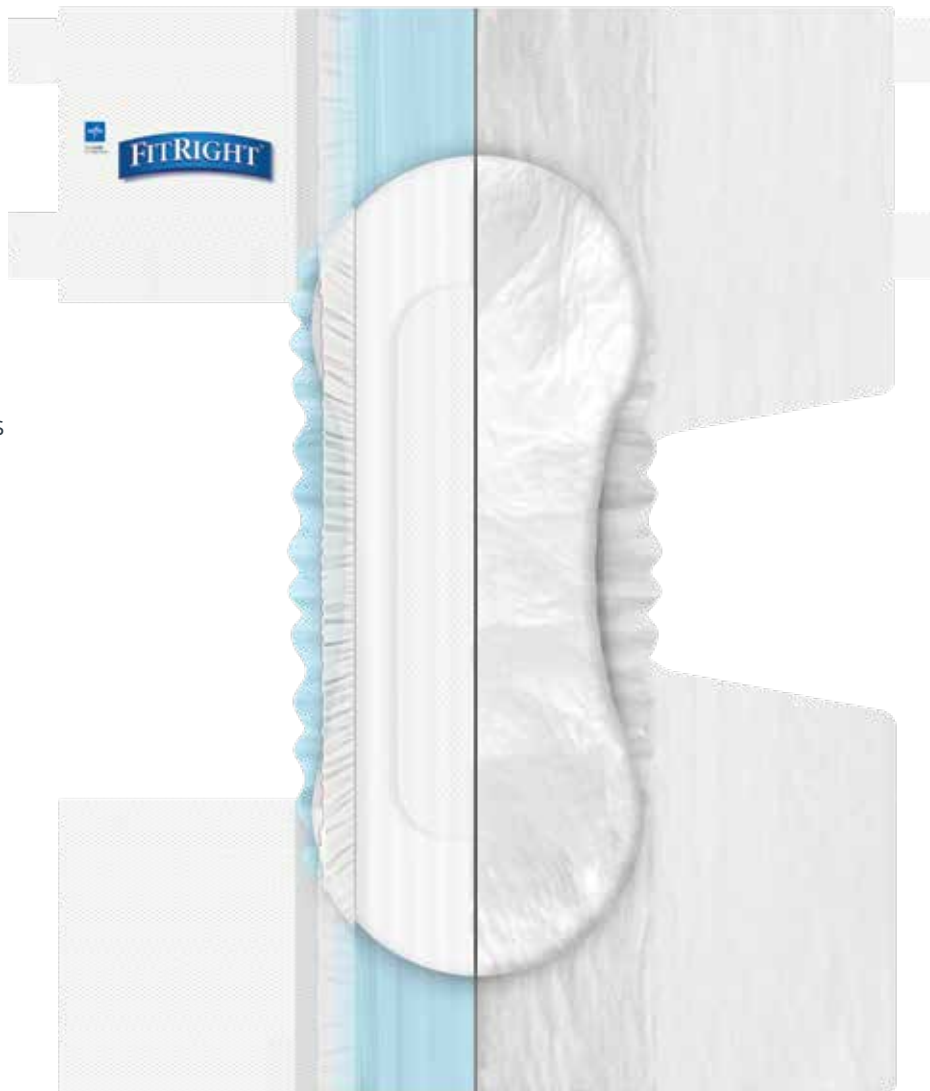

▶ **See the difference for yourself.**



Align the corners of the model and attach the sides to compare our OptiFit™ fit to traditional briefs.

FitRight Design



Traditional Cut



\*Based on 2021 GHX market intelligence data.

# Covering the **continuum of care**

No matter the need, we have the right products to help you provide the best care possible.

Look for these icons throughout the catalog to identify unique offerings:



**Extended Use™**



**ActivEdge™**



**Specialty Sizes**

## Briefs



Heavy bladder and bowel incontinence.

Pages 14–25

## Protective Underwear



Light daytime incontinence; extra protection at night.

Pages 26–33

## Bladder Control & Feminine Hygiene



Light bladder leakage and menstrual protection.

Pages 34–41

## Liners & Pants



Heavy bladder and bowel incontinence.

Pages 42–51

## Underpads & Ultrasorbs®



Open-to-air incontinence management, procedures and surface protection.

Pages 52–61

## Baby & Youth



Diapers and wipes for the little ones.

Pages 62–67

## Cleansing & Skin Care



Wipes, lotions and soaps for gentle cleaning.

Pages 68–77



**FITRIGHT**

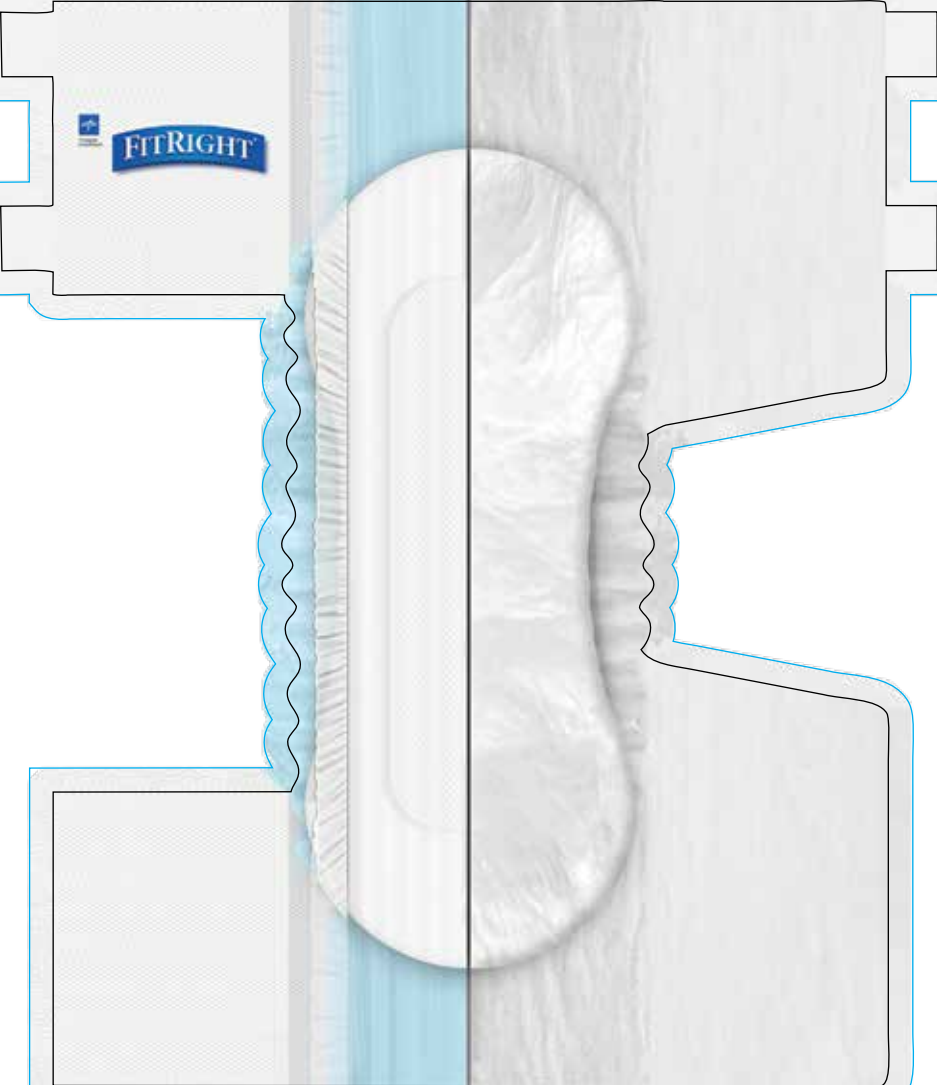

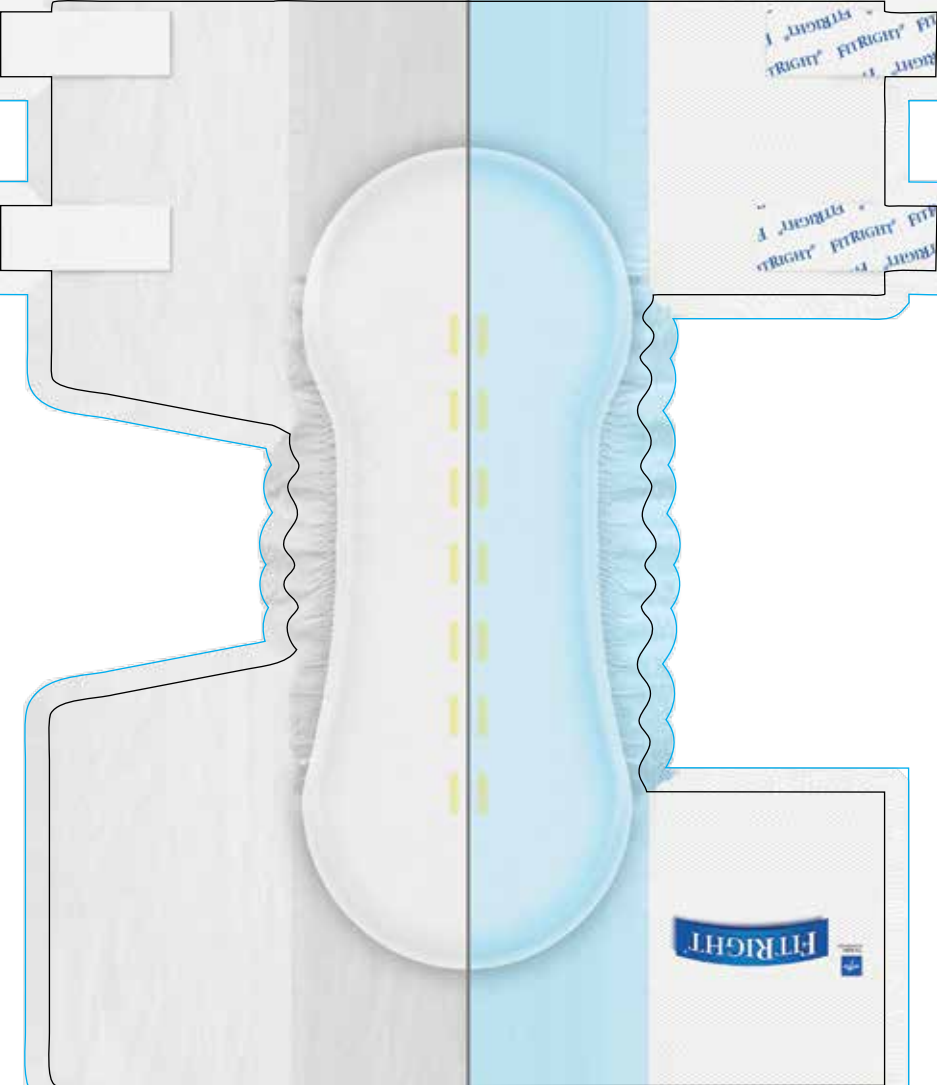

FitRight  
FitRight  
FitRight

FitRight







# Briefs



# Briefs

Made with a unique 4D Core™ that wicks away moisture and protects against odors. All FitRight briefs are designed to address two important incontinence concerns – keeping skin dry and maintaining skin integrity. Choose the one best suited to the individual's needs.

## Recommended for those who:

- Have heavy bladder and bowel incontinence
- Are bedbound and require a high level of caregiver assistance
- Need containment and maximum moisture protection
- Option to pair briefs with Double Up Booster Pads for added absorbency

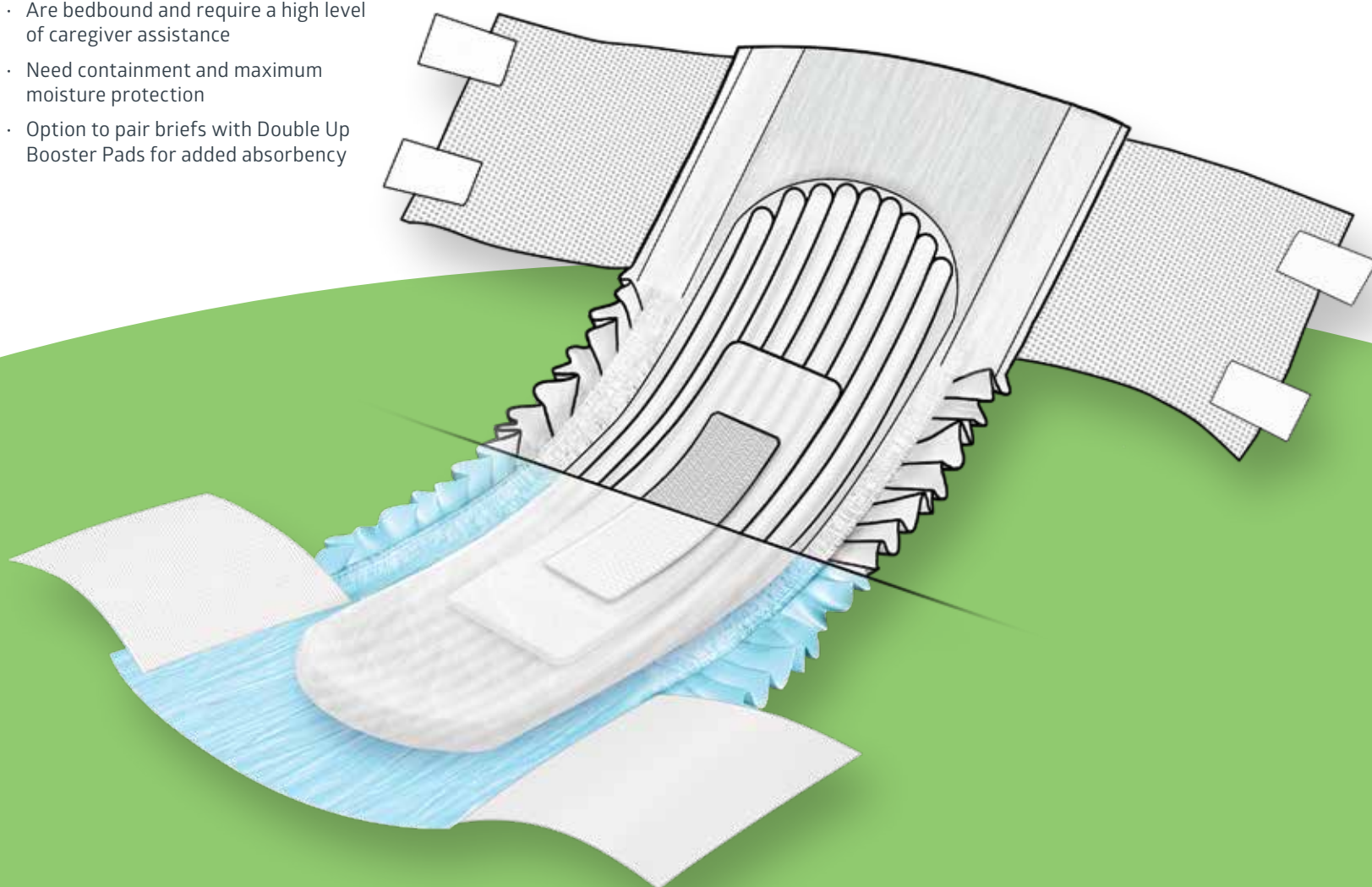

# Brief Types

## **OptIFit™ Briefs**

Our OptiFit™ Briefs provide the best possible fit for your resident. The 4D Core™ and core channel technology work to wick away fluids and protect against odors, including skin-safe closures for secure fastening and repositioning with a soft, garment-like feel.

## **EasyFlex™ Stretch Briefs**

With a large back panel for extra backside coverage, two-way stretch and a large single tab, our Stretch Briefs are easy to apply and comfortable to wear. And, like all our FitRight Briefs, they do a superior job of wicking away moisture and absorbing odors.

## **Remedy Briefs**

Infused with botanical nutrient cream, our Remedy Briefs are soothing to the skin.

With Leak-Stop™ Guards that keep fluid in, plus a breathable construction that promotes air flow.

## **Specialty Size Briefs**

With a high-capacity core, our Specialty Size Briefs bring all the benefits of FitRight to discreetly accommodate a range of individuals – including flexible stretch panels for a secure, comfortable fit, cloth-like outer cover and skin-safe closures.

## **Extended Wear™ Briefs**

Our Extended Wear and Extended Wear Stretch Briefs have a high-performance core designed to keep individuals dry for long periods. They feature a breathable film that allows airflow for an optimal microclimate for skin, plus soft Leak-Stop™ Guards for protection and containment.



# Available Features



	Essential	Extra	Ultra	Super	Extended Wear
 <b>OptiFit™</b> I-Design for optimal fit	✓	✓	✓	✓	
 <b>Traditional Fit</b> Wide backside coverage		✓	✓	✓	✓
 <b>Hybrid Design</b> Wide leg openings and backside coverage					✓
 <b>Leak-Stop™ Guards</b> Soft anti-leak guards for extra protection		✓	✓	✓	✓
 <b>Easy-Flex™ Stretch</b> For easy application and a secure fit		✓	✓	✓	✓
 <b>ComfortAir™</b> Breathable design for improved microclimate	✓	✓	✓	✓	
 <b>4D Core™</b> Wicks away moisture	✓	✓	✓	✓	✓
 <b>Medline Remedy®</b> Botanical skin cream				✓	

# Essential Briefs



## FitRight Essential Briefs

Item No.	Description	Color	Pkg.
FITBASICMD	Medium, 32-44" (81-112 cm)	White	25/bg, 100/cs
FITBASICLG	Large, 44-56" (112-142 cm)	Blue	25/bg, 100/cs
FITBASICXLG	X-Large, 56-64" (142-163 cm)	Beige	25/bg, 100/cs
FITBASICXXL	XX-Large, 60-70" (152-178 cm)	Green	25/bg, 100/cs



# Extra Briefs

Essential

**Extra**

Ultra

Super

Extended Wear



## Extra Briefs

Item No.	Description	Color	Pkg.
FITEXTRASM	Small, 20-32" (51-81 cm)	Peach	20/bg, 80/cs
FITEXTRAMD	Medium, 32-44" (81-112 cm)	White	20/bg, 80/cs
FITEXTRALG	Large, 44-56" (112-142 cm)	Blue	20/bg, 80/cs
FITEXTRXLG	X-Large, 56-64" (142-163 cm)	Beige	20/bg, 80/cs
FITEXTRAXXL	XX-Large, 60-70" (152-178 cm)	Green	20/bg, 80/cs



## Stretch Extra Briefs

Item No.	Description	Color	Pkg.
FRSE1	Size 1, 30-52" (76-132 cm)	Lavender	20/bg, 80/cs
FRSE2	Size 2, 51-70" (130-178 cm)	Green	20/bg, 80/cs



## Extra+ Briefs

Extra + Leak-Stop™ Guards

Item No.	Description	Color	Pkg.
FITPLUSMD	Medium, 32-44" (81-112 cm)	White	20/bg, 80/cs
FITPLUSLG	Large, 44-56" (112-142 cm)	Blue	20/bg, 80/cs
FITPLUSXLG	X-Large, 56-64" (142-163 cm)	Beige	20/bg, 80/cs
FITPLUSXXL	XX-Large, 60-70" (152-178 cm)	Green	20/bg, 80/cs



## Ultracare Clothlike Briefs

Item No.	Description	Color	Pkg.
ULTRACAREMD	Medium, 32-44" (81-112 cm)	White	24/bg, 96/cs
ULTRACARELG	Large, 44-58" (112-147 cm)	White	24/bg, 72/cs
ULTRACAREXLG	X-Large, 58-68" (147-173 cm)	White	20/bg, 60/cs

# Ultra Briefs

Essential

Extra

**Ultra**

Super

Extended Wear



## FitRight Ultra Briefs

Item No.	Description	Color	Pkg.
FITULTRASM	Small, 20-32" (51-81 cm)	Peach	20/bg, 80/cs
FITULTRAMD	Medium, 32-44" (81-112 cm)	White	20/bg, 80/cs
FITULTRALG	Large, 44-56" (112-142 cm)	Blue	20/bg, 80/cs
FITULTRAXLG	X-Large, 56-64" (142-163 cm)	Beige	20/bg, 80/cs
FITULTRAXXL	XX-Large, 60-70" (152-178 cm)	Green	20/bg, 80/cs



## FitRight Stretch Ultra Briefs

Item No.	Description	Color	Pkg.
FRSU1	Size 1, 30-52" (76-132 cm)	Lavender	20/bg, 80/cs
FRSU2	Size 2, 51-70" (130-178 cm)	Green	20/bg, 80/cs





### ComfortAire Briefs

Item No.	Description	Color	Pkg.
COMFORTAIREMD	Medium, 32–42" (81–107 cm)	White	24/bg, 96/cs
COMFORTAIRELG	Large, 48–58" (122–147 cm)	White	24/bg, 72/cs
COMFORTAIREX	X-Large, 59–66" (150–168 cm)	White	20/bg, 60/cs



### FitRight 3XL and 4XL Briefs



Item No.	Description	Color	Pkg.
MTB084	3XL, 71–84" (180–213 cm), Clothlike	White	12/bg, 48/cs
BARIBRIEFC	4XL, 65–94" (165–239 cm) Clothlike, Clear Bag	White	8/bg, 32/cs

# Super Briefs

Essential

Extra

Ultra

**Super**

Extended Wear



## FitRight Super Briefs with Remedy

Infused with Medline Remedy® Skin Repair Cream to nourish and soothe fragile skin.

Item No.	Description	Color	Pkg.
FITRESTOREMD	Medium, 32-44" (81-112 cm)	White	20/bg, 80/cs
FITRESTORELG	Large, 48-58" (122-147 cm)	Blue	20/bg, 80/cs
FITRESTOREXLG	X-Large, 57-66" (145-168 cm)	Beige	20/bg, 80/cs
FITRESTOREXXL	XX-Large, 60-69" (152-175 cm)	Green	20/bg, 80/cs



## FitRight Super Specialty Size Briefs

3X-5X

Item No.	Description	Color	Pkg.
BARIBRIEF	4XL, 65-94" (165-239 cm), Retail Bag	Beige	8/bg, 32/cs
BARIBRIEFPLUS	5XL, 90-106" (229-269 cm), Retail Bag	Beige	8/bg, 32/cs

# Extended Wear Briefs

Essential

Extra

Ultra

Super

Extended Wear



## FitRight Extended Wear™ Briefs



Item No.	Description	Color	Pkg.
MTB80200	Small, 19-31" (48-79 cm)	White	30/bg, 120/cs
MTB80300	Medium, 27-43" (69-109 cm)	White	15/bg, 60/cs
MTB80500	Large, 41-59" (104-150 cm)	White	15/bg, 60/cs
MTB80600	X-Large, 57-65" (145-165 cm)	White	15/bg, 60/cs



## FitRight Stretch Extended Wear™ Briefs



Item No.	Description	Color	Pkg.
FREW1	Size 1, 31-52" (79-132 cm)	White	20/bg, 80/cs
FREW2	Size 2, 40-70" (102-178 cm)	White	20/bg, 80/cs



# Protective Underwear



# Underwear

Made for ambulatory individuals, Medline underwear feature Leak-Stop™ Guards, moisture-wicking technology and reduced chafing and sound when in motion. Discreet and disposable, they provide exceptional comfort, worry-free containment and can be pulled on and off just like normal underwear.

## Recommended for those who:

- Have light to heavy bladder incontinence and/or occasional bowel incontinence
- Want discreet protection that fits and feels like everyday underwear
- Can walk on their own or need little to no assistance
- Are lightly incontinent during the day and may need a little extra protection at night
- Option to pair protective underwear with Double Up Booster Pads for added absorbency

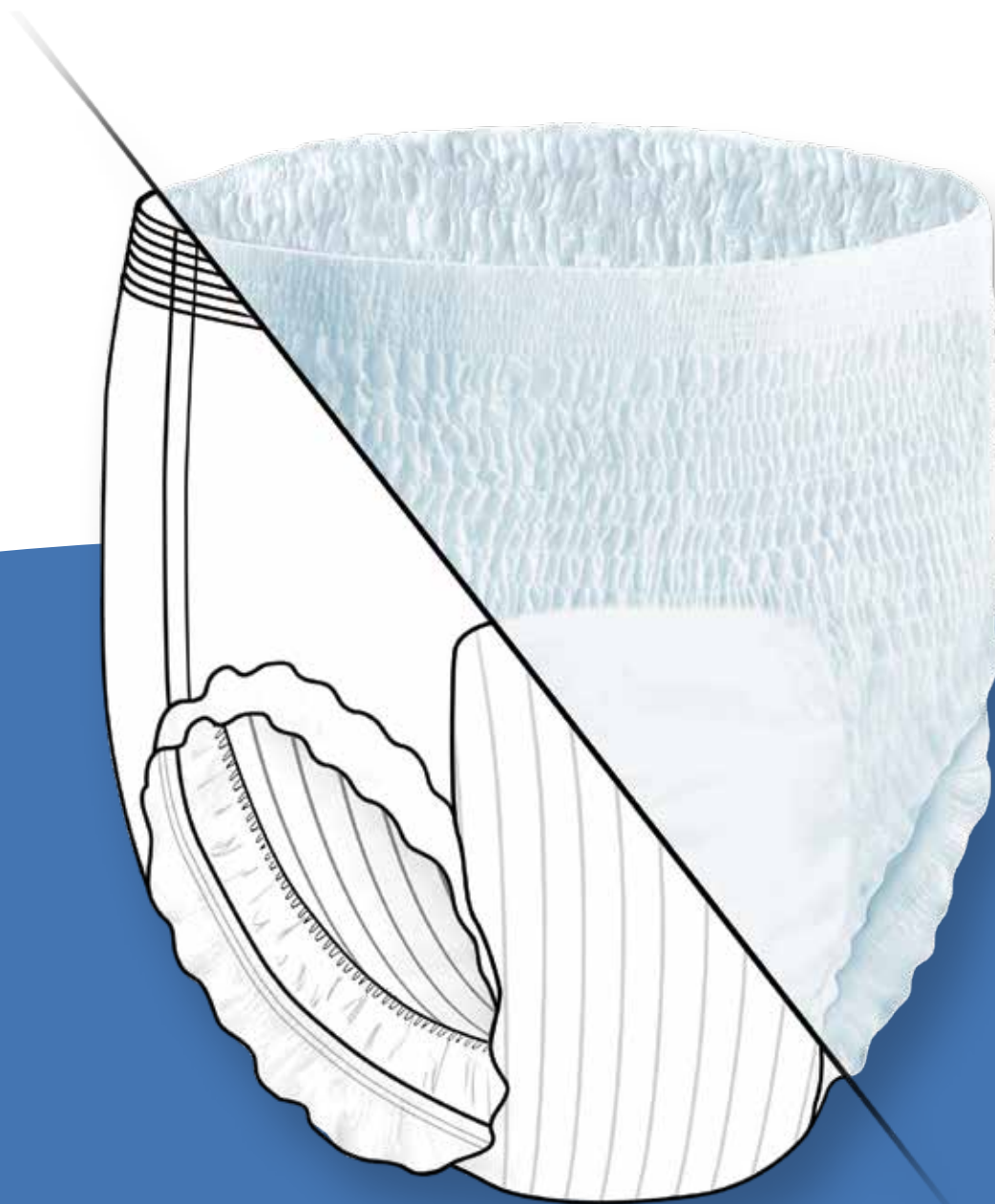

# Available Features



**Discreet Fit**



**Leak-Stop™ Guards**  
Soft anti-leak guards for extra protection



**SensiSoft™ Fabric**  
For a soft, garment-like fit



**MotionFlex™ Design**  
Allows easy range of movement



**ChannelWick™ Technology**  
Absorbent core keeps skin drier



## Extra Underwear

Extra

Ultra

Super

Extended Wear



### Extra Underwear

Item No.	Description	Pkg.
MSC13005A	Medium, 28–40" (71–102 cm)	20/bg, 80/cs
MSC13505A	Large, 40–56" (102–142 cm)	20/bg, 80/cs
MSC13600A	X-Large, 56–68" (142–173 cm)	20/bg, 80/cs

# Ultra Underwear

Extra

**Ultra**

Super

Extended Wear



## FitRight Ultra Underwear

Item No.	Description	Pkg.
FIT23005A	Medium, 28-40" (71-102 cm)	20/bg, 80/cs
FIT23505A	Large, 40-56" (102-142 cm)	20/bg, 80/cs
FIT23600A	X-Large, 56-68" (142-173 cm)	20/bg, 80/cs



## FitRight Underwear for Women and Men

In nude hues for women, dark gray for men.

Item No.	Description	Pkg.
FIT23WSM	Women, Small/Medium, 28-40" (71-102 cm)	20/bg, 80/cs
FIT23MSM	Men, Small/Medium, 28-40" (71-102 cm)	20/bg, 80/cs
FIT23WLXL	Women, Large/X-Large, 40-56" (102-142 cm)	20/bg, 80/cs
FIT23MLXL	Men, Large/X-Large, 40-56" (102-142 cm)	20/bg, 80/cs





### Medline Ultra Underwear

Item No.	Description	Pkg.
MSC23000	Small, 20–28" (51–71 cm)	22/bg, 88/cs
MSC23005	Medium, 28–40" (71–102 cm)	20/bg, 80/cs
MSC23505	Large, 40–56" (102–142 cm)	18/bg, 72/cs
MSC23600	X-Large, 56–68" (142–173 cm)	14/bg, 56/cs
MSC23700	XX-Large, 68–80" (173–203 cm)	12/bg, 48/cs

# Super Underwear



### FitRight Super Underwear

Item No.	Description	Pkg.
FIT33005A	Medium, 28–40" (71–102 cm)	20/bg, 80/cs
FIT33505A	Large, 40–56" (102–142 cm)	20/bg, 80/cs
FIT33600A	X-Large, 56–68" (142–173 cm)	20/bg, 80/cs

# Super Underwear

Extra

Ultra

**Super**

Extended Wear



## FitRight ActivEdge™ Underwear



Discreet fit with anti-bulk core and motion guards for on-the-go adults.

Item No.	Description	Pkg.
MSC19005	Medium, 28–40" (71–102 cm)	25/bg, 100/cs
MSC19505	Large, 40–56" (71–102 cm)	25/bg, 100/cs
MSC19600	X-Large, 56–68" (142–173 cm)	25/bg, 100/cs



## FitRight Specialty Size Underwear



A generous, flexible fit for maximum comfort.

Item No.	Description	Pkg.
FIT700A	XX-Large, 68–80" (173–203 cm)	20/bg, 80/cs
FIT800	3XL, 75–94" (191–239 cm)	20/bg, 80/cs



## Medline Protection Plus Underwear

Item No.	Description	Pkg.
MSC33255	Small, 20–28" (51–71 cm)	22/bg, 88/cs
MSC33005	Medium, 28–40" (71–102 cm)	20/bg, 80/cs
MSC33505	Large, 40–56" (102–142 cm)	18/bg, 72/cs
MSC33600	X-Large, 56–68" (142–173 cm)	14/bg, 56/cs
MSC33700	XX-Large, 68–80" (173–203 cm)	12/bg, 48/cs

# Extended Wear Underwear

Extra

Ultra

Super

Extended Wear



## FitRight Extended Wear™ Underwear



With an extended capacity core and Leak-Stop™ Guards for maximum containment, day and night.

Item No.	Description	Pkg.
MSC53005	Medium, 28–40" (71–102 cm)	16/bg, 64/cs
MSC53505	Large, 40–56" (102–142 cm)	14/bg, 56/cs
MSC53600	X-Large, 56–68" (142–173 cm)	12/bg, 48/cs



# Bladder Control & Feminine Hygiene

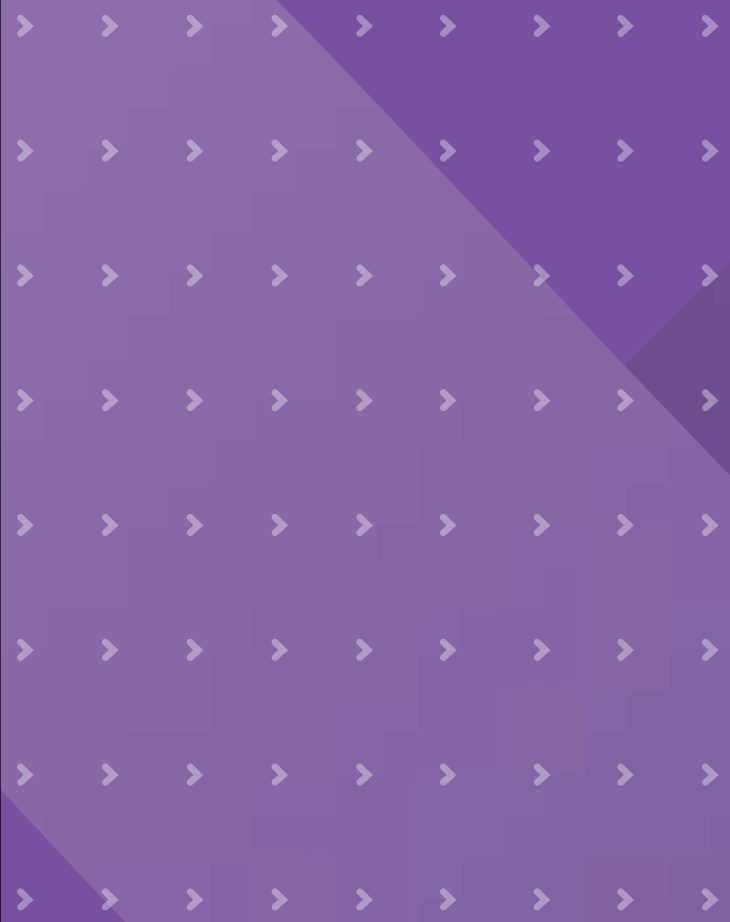

# Bladder Control Pads

Designed for those with light to moderate urinary incontinence, with a 4D Core™, odor protection and improved moisture wicking. These discreet bladder control pads feature an individualized, garment-like fit with increased airflow and a cloth-like backsheet for added comfort.

## Recommended for those who:

- Experience light bladder leakage
- Are looking for discreet protection to fit their everyday lives
- Can walk on their own but may need occasional assistance



# Available Features



Individually Wrapped



Long(er) Length



Adhesive Strip



50% Wider Back



## FitRight ActivEdge™ Women's Bladder Control Pads



- Designed for women, with a feminine design on the moisture-wicking topsheet
- Contoured for comfortable fit
- Absorbent core locks in moisture and odor and keeps skin dry
- Waterproof backsheet is soft, comfortable; doesn't make crinkle noises like plastic

Item No.	Description	Pkg.
FBC1010	Light, 3.5 x 9" (9 x 23 cm)	20/bg, 240/cs
FBC1020	Moderate, 4 x 11" (10 x 28 cm)	16/bg, 192/cs
FBC1030	Maximum, 5 x 14" (13 x 36 cm)	10/bg, 120/cs
FBC1040	Ultimate, 6 x 16" (15 x 40 cm)	10/bg, 120/cs



## FitRight Long Bladder Control Pads

- Longer length for increased absorbency and coverage
- Contoured for comfortable fit
- Motion guards

Item No.	Description	Pkg.
FBC1015	Light Long BCP – 3 x 11"	20/bg, 180/cs
FBC1025	Moderate Long BCP – 3.5 x 12.5"	16/bg, 144/cs
FBC1035	Maximum Long BCP – 4 x 15.75"	20/bg, 120/cs

# Bladder Control Pads



## FitRight Overnight Bladder Control Pads



- 50% wider backside for nighttime coverage
- Anatomical shape for comfortable fit

Item No.	Description	Pkg.
FBC1100	8.5 x 16"	20/bg, 80/cs



## Medline Bladder Control Pads

- For both men and women
- Super-absorbent polymer improves dryness, containment and skin care
- Elastic leg gathers help prevent leaks

Item No.	Description	Pkg.
MSC325100	Light, 2.75 x 9.75" (7 x 25 cm)	20/bg, 180/c
MSC326100	Moderate, 3 x 10.5" (8 x 27 cm)	16/bg, 144/cs
MSC327100	Maximum, 3.25 x 13" (8 x 33 cm)	14/bg, 126/cs





### Medline ContourPlus Bladder Control Pads

- Cloth-like outer cover provides a soft feeling on the skin and discreet fit
- Elastic leg gathers help prevent leaks
- Super absorbent core keeps moisture away from skin and controls odors
- Contoured design offers a comfortable fit
- For use by both men and women

Item No.	Description	Pkg.
BCPE01	Moderate, 5.5 x 10.5" (14 x 26 cm)	28/bg, 336/cs
BCPE02	Maximum, 6.5 x 13.5" (16 x 34 cm)	28/bg, 168/cs
BCPE03	Ultimate, 8 x 17" (20 x 43 cm)	28/bg, 168/cs



### FitRight ActivEdge™ Male Guards



- Features a soft breathable back sheet for comfort and discretion
- Super absorbent core with fast acquisition layer provides optimal dryness and protection

Item No.	Description	Pkg.
MSCMGO2	6 x 11" (14 x 25 cm)	52/bg, 208/cs



### FitRight Double Up Booster Pads

- Adds a second layer of absorbency to other incontinence products for extra protection
- Ultra-thin technology incorporates super-absorbent polymer to help keep fluid away from skin and control odors
- Adds 8+ extra ounces of absorbency\*

Item No.	Description	Pkg.
MSC326015	3.5 x 11.5" (9 x 29 cm)	24/bg, 192/cs
MSC90180	7 x 17" (18 x 42cm)	30/bg, 180/cs

\*Data on file.

# Feminine Hygiene



NON241278



NON241286



NON241289



NON500

## Menstrual Pads and Tampons

- Maximum absorbency for protection from leaks
- Variety of sizes, features and packaging options to fit each individual's needs

Item No.	Description	Pkg.
<b>With adhesive on entire length of pad</b>		
NON241278	Maxi, Non-Sterile, 9" (20 cm), indiv. boxed	1/bx, 250/cs
NON241279	Maxi, Non-Sterile, 9" (20 cm), indiv. wrapped	12/bg, 600/cs
NON241286	Maxi, Non-Sterile, 11" (28 cm), indiv. wrapped	12/bg, 288/cs

### With wings, adhesive on wings and back

NON241289	Maxi, Non-Sterile, 11" (28 cm), with wings	12/bg, 288/cs
-----------	--------------------------------------------	---------------

### Tampon, regular absorbency, vending machine compatible

NON500	Tampon, cardboard sleeve	Bulk, 500/cs
--------	--------------------------	--------------



NON241280

NON241281

## Maternity Pads

- Designed specifically for postpartum flow
- Sterile, non-sterile and sterilizable varieties
- Adhesive-free

Item No.	Description	Pkg.
NON241280	Non-Sterile, 11" (28 cm), with tails	12/bg, 288/cs
NON241281	Sterile, 11" (28 cm), with tails, indiv. wrapped	12/bg, 288/cs
NON241283	Sterilizable, 11" (28 cm), with tails, indiv. wrapped	12/bg, 288/cs
MDT214055	Sanitary belt for use with maternity pad	Bulk, 72/cs



MSC323950C



MSC322505

## Maternity Liners

- Super absorbent core locks fluids away from skin
- Adhesive strip attaches securely to user's underwear

Item No.	Description	Pkg.
MSC323950C	Contoured peach pad, 7 x 14"	20/bg, 240/cs
MSC323000C	Embossed liner, 7 x 17"	12/bg, 240/cs
MSC322505	Embossed liner, 9 x 24"	20/bg, 80/cs



# Liners & Pants

# Liners

A combination of liner and briefs is an ideal solution for those who wear underwear, self-toilet or are involved in a bladder and bowel program. With low-profile 4D Core™ for improved absorbency and leak and odor protection, our liners contain like a brief but are more comfortable and discreet.

## Recommended for those who:

- Experience heavy bladder and bowel incontinence
- Are bedbound or ambulatory
- Need containment and maximum protection against moisture

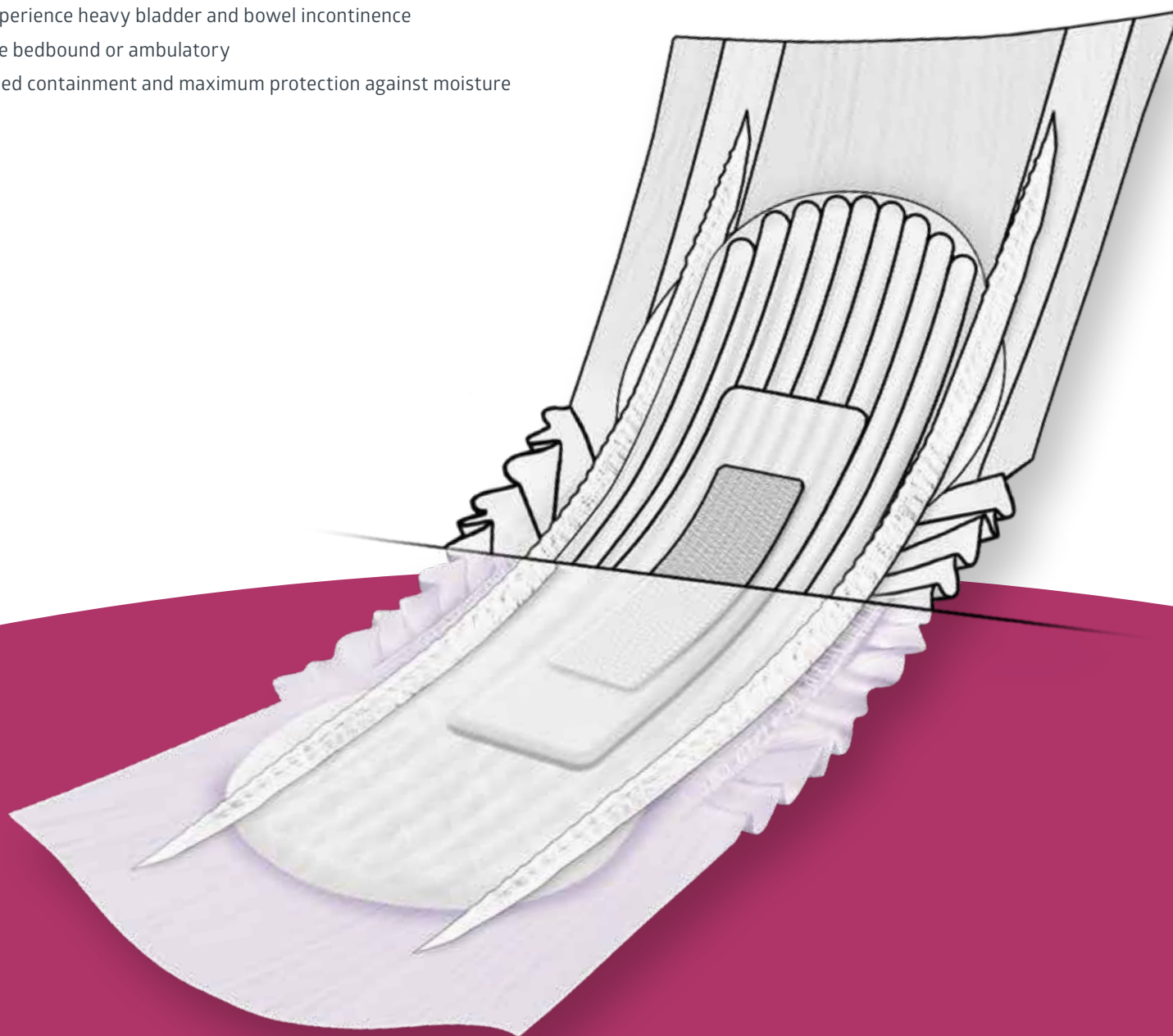

# Available Features



Extra

Ultra

Super

Extended Wear



**4D Core™**  
Wicks away moisture



**Leak-Stop™ Guards**  
Soft anti-leak guards for extra protection



**Medline Remedy®**  
Botanical skin cream



## How To Apply

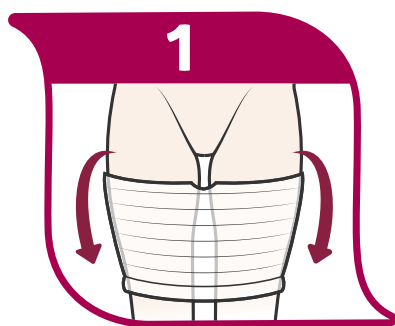

1  
Fold down knit or mesh pants (turning inside out) so waistband is below leg openings.

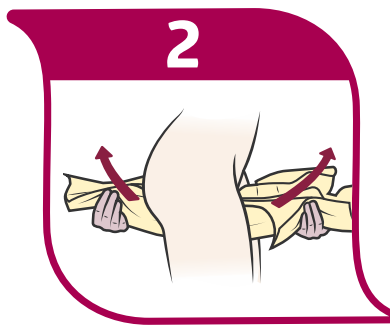

2  
Fold liner lengthwise and pull up between legs, then pull up front and back.

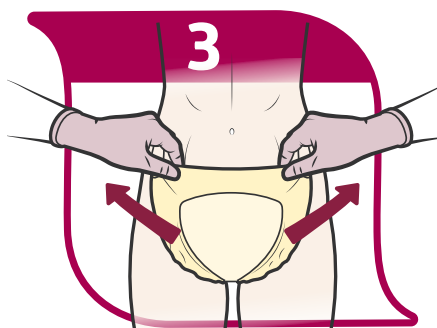

3  
Spread liner evenly in front and back for maximum coverage.

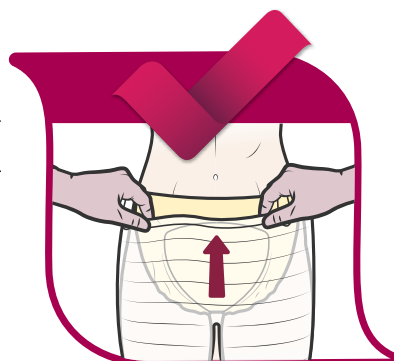

Pull up knit or mesh pants by waistband to hold liner in place and adjust as needed.



# Liners

Extra

Ultra

Super

Extended Wear



## FitRight Extra Liners

Low-profile core for improved comfort and fit

Item No.	Description	Color	Pkg.
FITLINER100	13 x 30" (33 x 76 cm)	Yellow	20/bg, 80/cs

Extra

Ultra

Super

Extended Wear



## FitRight Ultra Liners

Soft anti-leak guards to help improve containment

Item No.	Description	Color	Pkg.
FITLINER300	13 x 30" (33 x 76 cm)	Green	20/bg, 80/cs



Extra

Ultra

**Super**

Extended Wear



NEW  
PACKAGING  
COMING  
SOON

### FitRight Super Liners with Remedy

With a layer of Medline Remedy® Skin Repair Cream in the liner to nourish and soothe fragile skin

Item No.	Description	Color	Pkg.
FITLINER500	13 x 30" (33 x 76 cm)	Purple	20/bg, 80/cs

Extra

Ultra

Super

**Extended Wear**

NEW  
PACKAGING  
COMING  
SOON

3X-  
5X

### UltraSoft Bariatric Liners

Longer length for increased absorbency and coverage

Item No.	Description	Color	Pkg.
ULTRASOFTBARI	20.5 x 33" (52 x 84 cm)	White	18/bg, 72/cs

# Pants

Pants are used in conjunction with liners to provide discreet, comfortable protection against moisture.



## Black Maternity Knit Pants

- Full-coverage black pant
- Perfect for postpartum wear, with pads and ice
- High waist won't irritate C-section incisions
- Comfortable, machine-washable polyester/spandex blend

Item No.	Description	Pkg.
KNTPANTBL	Medium/Large, 20"-60" (51-152 cm) waist	2/bg, 50/cs
KNTPANTBXL	X-Large, 45"-70" (114-178 cm) waist	2/bg, 50/cs
KNTPANTBXXL	XX-Large, 50"-75" (127-191 cm) waist	2/bg, 50/cs



## Maternity Knit Pants

- New moms will appreciate the comfort and security of these knit pants
- Seamless to eliminate seams pressing into skin and lines under clothes
- Works with any of our incontinence liners and pads
- Color-coded waistbands for easy size identification

Item No.	Description	Color	Pkg.
MSC76400	Large/X-Large, 22-55" (60-140 cm) waist	Green	Bulk, 100/cs
MSC76500	XX-Large, 24-64" (61-163 cm) waist	Purple	Bulk, 100/cs



## Knit Pants

- Versatile design works with any of Medline's incontinence liners and pads
- Can be washed multiple times for convenient reuse
- Seamless design helps eliminate seams pressing into skin
- Knit weave is soft against the skin
- Color-coded waistbands make size identification simple

Item No.	Description	Color	Pkg.
MSC86300	Medium/Large, 20–60" (51–152 cm) waist	Blue/Brown	5/bg, 100/cs
MSC86400	X-Large, 45–70" (114–178 cm) waist	Green	5/bg, 100/cs
MSC86500	XX-Large, 50–75" (127–191 cm) waist	Purple	5/bg, 100/cs
MSC86700	3XL, 65–85" (165–216 cm) waist	Red	2/bg, 50/cs



## Mesh Pants

- Mesh pants are disposable and ideal for incontinence and maternity use
- Not made with natural rubber latex

Item No.	Description	Pkg.
MBP3202	Large, 30–45" (76–114 cm) waist	Bulk, 400/cs
MBP3703	X-Large, 32–48" (81–122 cm) waist	Bulk, 300/cs
MBP3704	XX-Large, 38–58" (97–147 cm) waist	Bulk, 300/cs
MBP3705	3XL, 52–82" (132–208 cm) waist	2/bg, 100/cs

# Hip Protectors



## Hip Protector

- Reduces the risk of hip fractures associated with a fall
- Breathable, comfortable and form-fitting
- Durable and machine washable
- Can be worn with or without incontinence liners

Item No.	Description	Pkg.
HIPPROTSM	Small, 30–38" (76–97 cm) waist	10/cs, 1/ea
HIPPROTMD	Medium, 35–43" (89–109 cm) waist	10/cs, 1/ea
HIPPROTLG	Large, 40–48" (102–122 cm) waist	10/cs, 1/ea
HIPPROTXL	X-Large, 44–56" (112–142 cm) waist	10/cs, 1/ea
HIPPROTXXL	XX-Large, 48–60" (122–152 cm) waist	10/cs, 1/ea



## Hip Protector Premium

- Can be washed multiple times for convenient reuse
- Sewn-in foam pads
- Breathable, comfortable microfiber pants
- Can be worn with or without incontinence liners

Item No.	Description	Pkg.
HIPPREMIUMS	Small, 30–38" (76–97 cm) waist	10/cs, 1/ea
HIPPREMIUMM	Medium, 35–43" (89–109 cm) waist	10/cs, 1/ea
HIPPREMIUML	Large, 40–48" (102–122 cm) waist	10/cs, 1/ea
HIPPREMIUMXL	X-Large, 44–54" (112–137 cm) waist	10/cs, 1/ea
HIPPREMIUMXXL	XX-Large, 48–60" (122–152 cm) waist	10/cs, 1/ea



## Open Hip Protector

- Increases impact time
- Breathable, comfortable material
- Quality pads and premium fabric

Item No.	Description	Pkg.
HIPPROTSM	Small, 30–38" (76–97 cm) waist	10/cs, 1/ea
HIPPROTMD	Medium, 35–43" (89–109 cm) waist	10/cs, 1/ea
HIPPROTLG	Large, 40–48" (102–122 cm) waist	10/cs, 1/ea
HIPPROTXL	X-Large, 44–56" (112–142 cm) waist	10/cs, 1/ea
HIPPROTXXL	XX-Large, 48–60" (122–152 cm) waist	10/cs, 1/ea





# Underpads & Ultrasorbs®

# Underpads

Disposable underpads provide moisture protection for a variety of surfaces. They feature a high-absorbency core that helps control odors and their polypropylene backing prevents fluid from passing through the pad.

## Recommended uses:

- Protecting bedding and furniture
- Use in clinical procedures
- Wheelchair seats
- IV starts

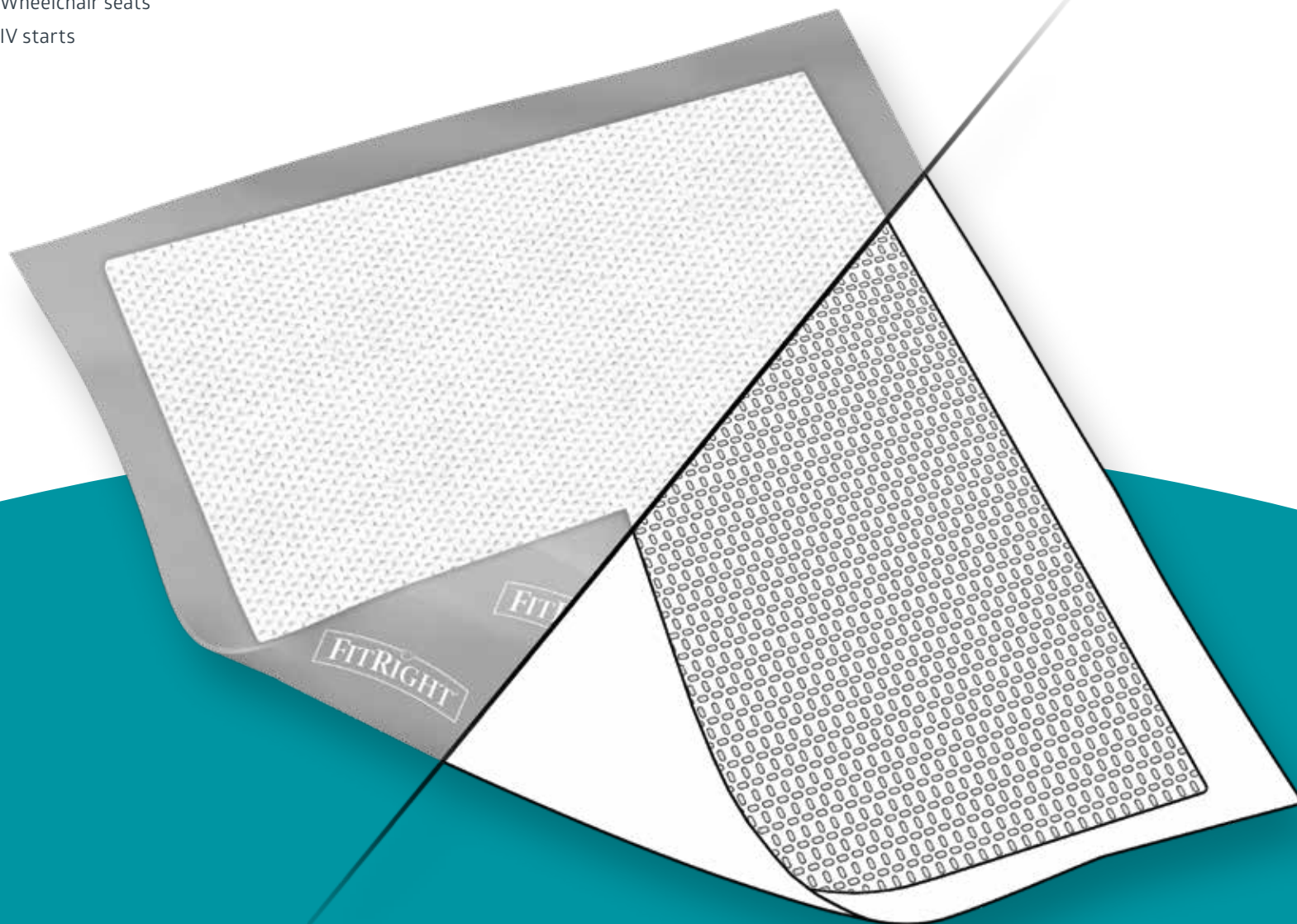





## Underpads

- Non-woven top sheet
- Disposable underpads feature combination of a fluff and polymer core for high absorbency and odor control
- Polypropylene backing prevents fluid from passing through the pad
- Available in quilted and non-quilted

Size & Recommended Use	Item No.	Description	Pkg.
<b>17" x 24"</b> IV starts and blood draws	MSC281224C	Low Absorbency, Quilted, Blue	25/bg, 300/cs
	MSC281230	Moderate Absorbency, Blue	Bulk, 300/cs
<b>23" x 24"</b> Seat cover, wheelchair cover, IV starts, dressing changes	MSC281225	Low Absorbency, Blue	Bulk, 200/cs,
	MSC281241LB	Moderate Absorbency, Blue	5/bg, 200/cs
<b>23" x 36"</b> Bedding protection	MSC281229C	Low Absorbency, Quilted, Blue	25/bg, 150/cs
	MSC281236P	Moderate Absorbency, Blue	10/bg, 150/cs
	MSC281264	Moderate Absorbency, Quilted, Blue	25/bg, 150/cs
	MUP2060P	Heavy Absorbency, Green	10/bg, 80/cs
	EXTRASRB2336A	Super Absorbency, Quilted, White	5/bg, 70/cs
<b>30" x 30"</b> Procedures	MSCB281245LB	Low Absorbency, Quilted, Blue	5/bg, 150/cs
	MUP1266P	Moderate Absorbency, Blue	10/bg, 90/cs
	MSC282045	Heavy Absorbency, Quilted, Teal	10/bg, 100/cs
	MUP0305P	Heavy Absorbency, Green	10/bg, 90/cs
<b>30" x 36"</b> Bedding protection, labor & delivery, operating room	MSC282033P	Moderate Absorbency, Green	10/bg, 100/cs
	MUP0365P	Heavy Absorbency, Green	10/bg, 80/cs
	MSC282030LBC	Heavy Absorbency, Quilted, Green	5/bg, 75/cs
	EXTRASRB3036A	Super Absorbency, Quilted, White	5/bg, 70/cs
<b>36" x 36"</b> Bedding protection	MSC281271P	Moderate Absorbency, Quilted, Green	5/bg, 50/cs
	MSC282070LB	Heavy Absorbency, Quilted, Green	5/bg, 50/cs

# Underpads



## FitRight Underpads

- Provide moisture protection for a variety of surfaces, including exam tables, beds and chairs
- Polypropylene backing helps prevent leaks

Size	Item No.	Description	Pkg.
30 x 30"	MUP1000F	Fluff & Polymer	10/bg, 90/cs
30 x 36"	MUP2000F	Fluff & Polymer	10/bg, 100/cs
23 x 36"	MSC281150	Fluff	15/bg, 150/cs



## FitRight Extended Use™ Underpads



- Soft, quilted topsheet provides a soft feel for sensitive skin
- Premium poly backing won't leak, helps pad stay in place
- 5 times more absorbent than the leading competitive brand\*

Size	Item No.	Description	Pkg.
23 x 36"	FPU2336	Fluff & Polymer, Quilted	10/bg, 70/cs
30 x 36"	FPU3036	Fluff & Polymer, Quilted	5/bg, 70/cs

\* Data on file



### Specialty Underpads

- Provides moisture protection for a variety of clinical surfaces, including exam tables, beds and chairs
- MC241216 can be tucked under a mattress to keep it in place during movement

Size	Item No.	Description	Pkg.
9 x 14"	MSC280914	Fluff & Polymer, Crib Liner	50/bg, 600/cs
27 x 70"	MSC241216	Fluff & Polymer, Tuckable	5/bg, 75/cs



### Breathable Underpads

- Features a breathable backing for maximum airflow and improved microclimate

Size	Item No.	Description	Pkg.
21 x 36"	MSC282110	Fluff and Polymer, Quilted	5/bg, 50/cs

# Ultrisorbs®

Ultrisorbs premium underpads fight skin breakdown with powerful absorbing technology.

To provide an ideal microclimate, it's important to use products that absorb and hold moisture away from the skin. Ultrisorbs are made with ultra-soft, air-permeable materials to keep skin dry, control odors and provide maximum user comfort. The backsheet features an AquaShield film to keep fluid contained, and weight capacity options help make boosting and repositioning easy. They're also suitable for use with specialty mattresses.



Medline's Ultrasorbs portfolio includes a variety of options to help your team manage moisture.

	Ultrasorbs	Ultrasorbs Advanced	Ultrasorbs Advanced+	Ultrasorbs Complete
<b>Weight Capacity</b>	N/A	300–375 lbs.	300–375 lbs.	400 lbs.
<b>Core Style</b>	Standard	Standard	Extended	Rapid wicking
<b>Air Permeability</b>	Yes	Yes	Yes	Yes

\* 20% larger core



EXTRASRB3036A

### Ultrasorbs

Size	Item No.	Weight Cap.	Pkg.
Ultrasorbs 10" x 16"	ULTRASORB1016	n/a	10/bg, 100/cs
Ultrasorbs 23" x 36"	EXTRASRB2336A	n/a	10/bg, 70/cs
Ultrasorbs 30" x 36"	EXTRASRB3036A	n/a	5/bg, 70/cs



MSC8003003

### Ultrasorbs Advanced

Size	Item No.	Weight Cap.	Pkg.
Ultrasorbs Advanced 30" x 36"	MSC8003003	300 lbs.	5/bg, 70/cs
Ultrasorbs Advanced 30" x 36"	EXTSB3036A350	350 lbs.	5/bg, 70/cs
Ultrasorbs Advanced 30" x 36"	USAP3136ESLP	375 lbs.	10/bg, 50/cs
Ultrasorbs Advanced with SlipResist 30" x 36"	MSC383500	300 lbs.	5/bg, 70/cs

PATENT  
PENDING  
BACKSHEET  
TECHNOLOGY



ULTRASORB3136

### Ultrasorbs Advanced+

Size	Item No.	Weight Cap.	Pkg.
Ultrasorbs Advanced+ 23" x 36"	ULTRASORB2436	300 lbs.	10/bg, 70/cs
Ultrasorbs Advanced+ 30" x 36"	ULTRASORB3136	300 lbs.	10/bg, 40/cs
Ultrasorbs Advanced+ 30" x 36"	USAP3136ES	375 lbs.	10/bg, 40/cs
Ultrasorbs Advanced+ 40" x 57"	MSC282900	375 lbs.	5/bg, 60/cs



MDP733036

### Ultrasorbs Complete

Medline-exclusive SlipResist Technology prevents pad bunching, slipping and migration

Size	Item No.	Weight Cap.	Pkg.
Ultrasorbs Complete 30" x 36"	MDP733036	400 lbs.	5/bg, 60/cs

# Other MASD Solutions

Moisture-associated skin damage (MASD) negatively impacts the physical health of your residents and the financial health of your facility. Medline offers products to help reduce MASD exposure for the most at-risk individuals.



## Skinfold Dry Sheets

The soft outer layer of our Skinfold Dry Sheet absorbs moisture and keeps it away from the skin, locking it into the double-thick, super-absorbent polymer core.

- Designed to absorb moisture and help keep skinfolds dry
- Soft, non-chafing material for cooling and comfort
- Change once a day or when sheet becomes wet
- One sheet holds 8 oz. of liquid

Item No.	Description	Pkg.
MSC10614	6 x 14" (15 x 35 cm)	10/bg, 250/cs



## QuickChange™ Male Wrap

The QuickChange Incontinence Wrap applies directly around the male anatomy to provide one-size-fits-all urinary containment.

- Unique shape designed to fit all anatomy types without patient repositioning
- Moisture-wicking design allows air flow to at-risk skin areas for a healthy microclimate
- Easy application and removal with adhesive-free hook & loop closure

Item No.	Description	Pkg.
UIM1025	Male Incontinence Wrap	25/bg, 100/cs
UIM1010	Male Incontinence Wrap	10/bg, 100/cs







# Baby & Youth

# Baby & Youth

Help little ones stay dry and keep skin healthy with premium quality products. Medline's baby diapers are made with soft, hypoallergenic materials that are gentle on delicate skin. Anti-leak guards provide extra protection, while stretch waist bands and side panels offer custom comfort and range of movement.





## Medline Baby Diapers

- Repositionable tabs enable the perfect fit for each unique child size
- Wetness indicators change color when diaper is soiled

Item No.	Description	Pkg.
MBD200N	Newborn, <10 lbs (<4 kg)	25/bg, 200/cs
MBD2001	Size 1, 8-14 lbs (3-6 kg)	25/bg, 200/cs
MBD2002	Size 2, 12-18 lbs (5-8 kg)	25/bg, 200/cs
MBD2003	Size 3, 16-28 lbs (7-13 kg)	25/bg, 200/cs
MBD2004	Size 4, 22-37 lbs (9-17 kg)	25/bg, 200/cs
MBD2005	Size 5, 27+ lbs (12+ kg)	25/bg, 200/cs
MBD2006	Size 6, 35+ lbs (16+ kg)	25/bg, 200/cs
MBD2007	Size 7, 41+ lbs (18+ kg)	25/bg, 200/cs



## Thin Booster Diaper Liners

- Can help reduce diaper leaks for babies and toddlers, and increase diaper absorbency by 10 oz.
- Adhesive strip keeps pad in place for overnight, naps and travel
- Designed to fit most diapers and training pants
- Fragrance and chlorine free for peace of mind
- Pad is breathable and flows through to diaper

Item No.	Description	Pkg.
BBP326015	Thin Booster Diaper, 3.5" x 11.5"	24 bg, 192/cs

# Baby & Youth



## Medline Baby Wipes

- Soft and gentle on skin
- Hypoallergenic and pH-balanced
- Alcohol, paraben and phthalate free

Item No.	Description	Pkg.
MSC263040	Peel and Reseal, Fragrance Free	40/pk, 24 pk/cs
MSC263080	Flip-Top Lid, Scented	80/pk, 15 pk/cs
MSC263153	Aloetouch, Peel and Reseal, Fragrance Free	80/pk, 24 pk/cs
SWW720	99% Water, Flip-Top Lid	60/pk, 12 pk/cs



## Medline Disposable Dry Cleansing Cloths

- Fragrance free cloths gently cleanse sensitive, fragile skin – just add water
- Made of Soft-Spun fabric that is softer than reusable cloths
- Disposable, nonflushable cloths help reduce the risk of cross contamination and can't dry out like traditional wet wipes

Item No.	Description	Pkg.
BBYSOFT1013	10 x 13" (25 x 33 cm)	50/pk, 500/cs



### Medline Training Pants

- Full-stretch waistband feels like real underwear
- Cloth-like outer cover is comfortable against skin, helping to minimize the risk of irritation and rashes
- Easy-change design allows for quick removal
- Wetness indicators change color when pants are soiled

Item No.	Description	Pkg.
HSP29817	Medium, 2-3T, 20-32 lbs (9-15 kg)	17/bg, 136/cs
HSP29815	Large, 3-4T, 32-40 lbs (15-19 kg)	15/bg, 120/cs
MSC29813	X-Large, 4-5T, 38+ lbs (18+ kg)	13/bg, 104/cs



### Medline Youth Underwear

- Provides day and night protection
- Looks and feels like underwear, with discreet design and soft waist/hip elastic

Item No.	Description	Pkg.
MSC23001A	Small/Medium, 40-70 lbs (18-31 kg)	15/bg, 60/cs
MSC23003A	Large/X-Large, 60-125 lbs (27-56 kg)	12/bg, 48/cs



# Cleansing & Skin Care

# Dry Wipes

Every day, healthcare providers face a wide range of messes. The selection of clean-up options is even wider – and choosing the right one takes time. Our collection of multi-purpose dry wipes is the clean-up solution you don't have to think about. Soft, durable and endlessly versatile, they're the go-to for healthcare providers across the industry.

## Recommended for:

- Incontinence cleanup
- Applying ointments, creams and protective barriers
- Pericare and bathing
- Use on fragile skin, where rough terry cloth may cause irritation
- General cleaning



## UltraSoft™ Disposable Dry Cleansing Cloths

- Made of Soft-Spun fabric that's softer than reusable cloths
- No additives – alcohol free, fragrance free, paraben free
- Gentle wipes are ideal for incontinence care, patient bathing and more

Item No.	Description	Pkg.
ULTRASOFT1013	10 x 13"	500/cs
ULTRASOFT1214	12 x 14"	1080/cs
ULTRASOFT713	7 x 13"	1200/cs
NON1013	10 x 13"	1000/cs
FRDW263854	FitRight Pop Top 8" x 8"	1200/cs





## NatureSoft™ Flushable Dry Cleansing Wipes

- Wipes break down when flushed – safe for septic tanks
- Up to 15 times more dispersible than competitors and 7 times more than our previous blend\*
- Cloth-like fibers are strong and gentle

Item No.	Description	Pkg.
NATURESOFT913	Flushable, 9" x 13"	50 ea/bg, 500 ea/cs

Made with materials that biodegrade per ISO 14851.  
\*Data on file and available upon request.



## Medline Absorbent Wipers+ Dry Wipes

- Made of durable, absorbent material
- Resists tearing to handle tough cleaning needs
- Strong, absorbent wipes are ideal for cleaning up spills and surfaces

Item No.	Description	Pkg.
AWP0500	Absorbent, 12" x 13"	90 ea/bg, 1080 ea/cs

# Wet Wipes

No need for harsh soaps and rough washcloths – our disposable cleansing cloths reduce odor and are more sanitary, comfortable and efficient. They feature a pH-balanced formula that's hypoallergenic and alcohol-free, so it's gentle on skin. As the market leader in personal cleansing cloths, we're sure to have the right product to suit every individual.



## Recommended for:

- Fast, efficient cleaning
- Gentle enough even for sensitive skin



**ENRICHED WITH  
SOOTHING ALOE**



**A SOFTER,  
GENTLER TOUCH**



**CONVENIENT AND  
EASY TO USE**



**REDUCES  
ODOR**



### FitRight Standard Weight Wet Wipes

- Full-sized, standard weight, durable wet wipes with a touch of soothing aloe are ideal for everyday clean-ups and incontinence care
- Single patient use wipes help to reduce the risk of cross contamination

Item No.	Description	Pkg.
MSC263654	8 x 12", Scented, Flip-Top Lid	48/pk, 12 pk/cs
MSC263754	8 x 10", Scented, Peel & Reseal	68/pk, 12 pk/cs
MSC263854	8 x 10", Scented, Flip-Top Lid	100/pk, 6 pk/cs
MSC263954	8 x 12", Fragrance Free, Flip-Top Lid	100/pk, 6 pk/cs



### FitRight Quilted Heavy Weight Wet Wipes

- Full-sized durable wet wipes feature a quilted texture for maximum comfort
- Ideal for everyday clean-ups and incontinence care
- Single patient use wipes help to reduce the risk of cross contamination

Item No.	Description	Pkg.
MSC263625	8 x 12", Quilted, Fragrance Free, Flip-Top Lid	48/pk, 12 pk/cs



### Aloetouch® Select Medium Weight Wet Wipes

- Super-soft, single patient use, spunlace wipes are gentle on the skin
- Versatile and convenient wipes are ideal for everyday clean-ups and incontinence care
- Wipes are pre-moistened with rinse-free formula that cleans, moisturizes and soothes the skin

Item No.	Description	Pkg.
MSC095280	8 x 12", Scented, Peel & Reseal	24/pk, 1 pk/cs
MSC263701	8 x 12", Scented, Tub	48/tub, 12 tub/cs

# Wet Wipes



## ReadyFlush® Biodegradable Flushable Wipes

- A flushable and dispersible, single patient use wet wipe made from hydraspun dispersible cloth fibers
- The fibers break down quickly when flushed, yet are still strong in use
- Wipes are pre-moistened with rinse-free formula that cleans, moisturizes and soothes the skin

Item No.	Description	Pkg.
MSC263800	8 x 12", Scented, Tub	60/tub, 9 tub/cs
MSC263810	8 x 10", Scented, Peel & Reseal	24/pk, 24 pk/cs
MSC263820	7 x 8", Fragrance Free, Peel & Reseal	40/pk, 24 pk/cs
MSC263830	8 x 12", Fragrance Free, Peel & Reseal	24/pk, 24 pk/cs



## ReadyFlush® Select

- Premium thickness, single patient use wet wipe made from hydraspun dispersible cloth fibers that break down quickly when flushed, yet are still strong in use
- Wipes are pre-moistened with rinse-free formula that cleans, moisturizes and soothes the skin
- Formula is pH-balanced, hypoallergenic and does not contain alcohol

Item No.	Description	Pkg.
MSC263840	8 x 10", Flip-Top Lid	48/pk, 12 pk/cs



# Skin Care

The Medline Remedy® Phytoplex® line combines the most advanced skin care science with some of the gentlest, most beneficial botanicals nature provides. The result is a complete regiment of skin care specifically formulated for use on sensitive skin.

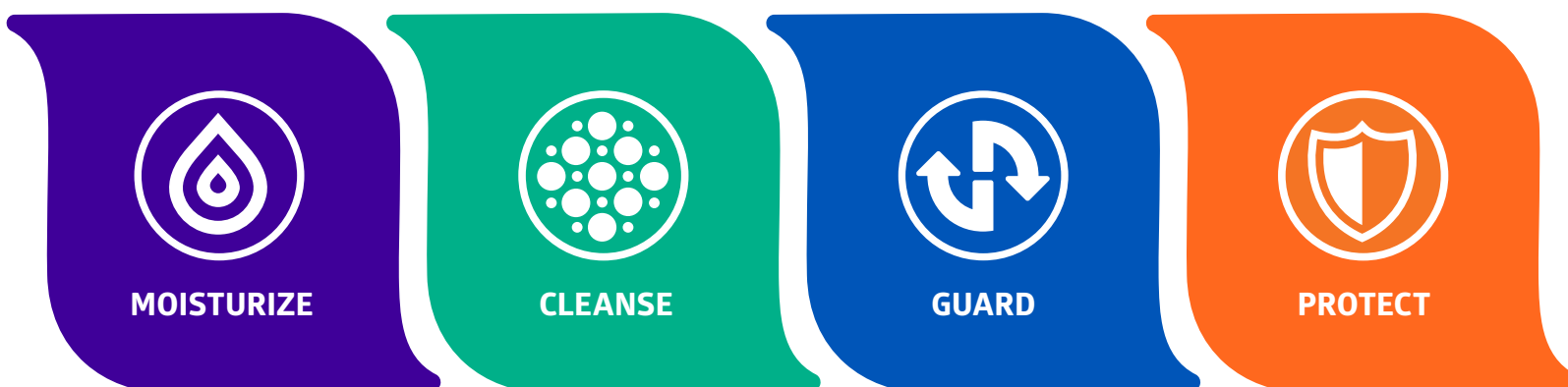

## Remedy Phytoplex Nourishing Skin Cream

- Provides hydration, nourishment and moisture balance to help maintain skin's natural defenses
- Enhanced with Phytoplex, additional botanicals and essential fatty acids
- Formulated without mineral oil or other petrochemicals to remain breathable
- Hypoallergenic, non-irritating, non-sensitizing, latex compatible, pediatrician and dermatologist recommended
- Ideal for use on hands, face and body



Item No.	Description	Pkg.
MSC0924002	2-oz. Tube	24/cs, 1/ea
MSC0924002UNS	2-oz. Tube, Unscented	24/cs
MSC0924004	4-oz. Tube	12/cs, 1/ea
MSC0924004UNS	4-oz., Unscented	12/cs
MSC092402PACK	4 mL Packet	144/gr
MSC092408	8-oz. Bottle	24/cs, 1/ea
MSC092416	16-oz. Pump	12/cs, 1/ea
MSC092416UNSC	16-oz. Pump, Unscented	12/cs
MSC092432	32-oz. Pump	12/cs
MSC092432UNSC	32-oz. Pump, Unscented	12/cs
MSC092434	1000 mL	8/cs
MSC092434UNSC	1000 mL, Unscented	8/cs



## Remedy Phytoplex Foaming Cleanser

- Gentle, no-rinse cleanser for hair, face and body
- Removes difficult barrier pastes and creams, as well as blood and fecal matter
- For use on intact, irritated or denuded skin
- Enhanced with botanical ingredients that are hypoallergenic, non-irritating and non-sensitizing

Item No.	Description	Pkg.
MSC092104	4-oz.	24/cs, 1/ea
MSC092104UNSC	4-oz., Unscented	24/cs
MSC092108	8-oz.	12/cs, 1/ea



## Remedy Phytoplex Hydraguard®

- 24% silicone blend helps to moisturize, nourish and resist moisture loss
- Appropriate for perineal care since it forms a breathable film over skin
- Improves the appearance of dry, itchy skin while providing moisturization
- Rich in oleosomes: naturally encapsulated safflower oils that release their oils over time
- Hypoallergenic, non-irritating, non-sensitizing, pediatrician and dermatologist recommended

Item No.	Description	Pkg.
MSC092532	2-oz.	24/cs, 1/ea
MSC092532UNSC	2-oz., Unscented	24/cs, 1/ea
MSC092534	4-oz.	12/cs, 1/ea
MSC092534PACK	4 mL Packet	144/gr
MSC092534UNSC	4-oz., Unscented	12/cs, 1/ea



## Remedy Phytoplex Z-Guard®

- Temporarily protects and helps relieve chapped or cracked skin, minor cuts, scrapes and burns
- White petrolatum-based formulation seals out wetness on intact, irritated or denuded skin
- Enhanced with zinc oxide, allantoin, natural oils and Phytoplex
- Formulated without menthol that may cause discomfort to some people
- Hypoallergenic, non-irritating, non-sensitizing, pediatrician and dermatologist recommended – ideal for all ages

Item No.	Description	Pkg.
MSC092542	2-oz.	24/cs, 1/ea
MSC092544	4-oz.	12/cs, 1/ea
MSC092544PACK	4 mL Packet	144/gr

# Easy-to- implement program

Our comprehensive, easy-to-implement Incontinence Solutions Program emphasizes practice and technique combined with high-quality products to help caregivers through the challenges of managing incontinence. From online education to product sizing tools, we go beyond briefs to help you provide the best care and improve outcomes.

## What to expect

Communication is key to a smooth and efficient incontinence product trial. The week before kickoff, your Medline contact will meet with you to establish goals and objectives for the incontinence trial. We will also order the appropriate trial products for you at no cost. Training and clinical support will be provided every step of the way.

## What's next?

Upon successful trial of Medline FitRight incontinence products, we will develop a plan to implement the full solution across your entire healthcare facility.



[medlineuniversity.com](https://www.medlineuniversity.com)



Scan here to  
learn more





# Kickoff week at a glance\*

## BEFORE KICKOFF WEEK BEGINS

Medline team members will collect resident sizing information, skin conditions and ask about any special concerns. Staff members will complete a pre-trial survey.

## MONDAY

Medline team members arrive early to coordinate logistics; such as stocking product, setting up carts and acquainting themselves with the necessary members of your staff.

## TUESDAY

Clinicians and caregivers begin using Medline FitRight incontinence products on the individual residents that are selected for the trial.

## WEDNESDAY

Medline team members continuously check in with staff and provide additional product training and troubleshooting as needed.

## THURSDAY

Trial surveys are completed and collected throughout the week.

## FRIDAY

Staff survey results are compiled into an executive summary to present to your facility's decision makers. Next steps are identified.

\*Schedule can be adjusted to meet your specific needs.



## We're with you for the long run

Both during the trial period and afterwards, we'll be here with ongoing education for your staff, including one-on-one sessions for new team members, product education, sizing refreshers and more.

# Growing your business

Medline has developed incontinence solutions, not only for healthcare facilities, but also for HME providers who serve their communities. We strive to bring value to our HME partners far beyond shipping boxes.

## A **trusted healthcare brand** that isn't sold in big box stores

- ✓ Case and bag packaging to maximize allowables and reimbursement
- ✓ Drop-ship programs that allow you to use our warehouses as your own



**Retail solutions** such as planograms and in-store displays



**Customizable sales  
and marketing tools**  
to help you grow your business

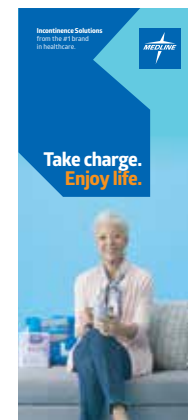



## Medline Industries

FOLLOW US [f](#) [in](#) [t](#) [BLOG](#)

Some products may not be available for sale in Mexico or Canada. We reserve the right to correct any errors that may occur within this catalog.  
©2022 Medline Industries, LP. Medline, FitRight, Ultrasorbs, Remedy, Phytoplex, Hydraguard, Z-Guard, Aloetouch, ReadyFlush are registered trademarks and OptiFit, Leak-Stop Guards, 4D Core, EasyFlex Stretch, ComfortAir, Extended Wear, Extended Use, SensiSoft, ChannelWick, MotionFlex, ActivEdge, QuickChange, NatureSoft, UltraSoft and The Leader in Healthcare are trademarks of Medline Industries, LP. MKT19W1666265 / LIT050 / SG / 10