

# CPP Ceiling Track Hoist



User Manual

## Contents

|       |   |    |
|-------|---|----|
| 1.0   | Safety Instructions and Warnings        | 4  |
| 1.1   | Introduction                            | 4  |
| 1.2   | Manufacture                             | 5  |
| 1.3   | European Authorised Representative      | 5  |
| 1.4   | Symbols Used                            | 6  |
| 1.5   | Contraindications/Limitations           | 7  |
| 1.6   | Intended Use                            | 7  |
| 1.7   | Additional Warnings and Safety Notices  | 9  |
| 1.8   | Operating Environment                   | 9  |
| 1.9   | Essential Performance                   | 10 |
| 1.10  | EMC Statement                           | 10 |
| 2.0   | Components/Key Parts                    | 12 |
| 2.1   | Unpacking                               | 12 |
| 3.0   | Installation                            | 13 |
| 4.0   | Type 'BF' Applied parts                 | 14 |
| 5.0   | Frequently Used Functions               | 14 |
| 5.1   | Carry Bar                               | 14 |
| 5.2   | Slings                                  | 15 |
| 5.3   | Connecting the Handset to the Hoist     | 23 |
| 6.0   | Hoist Operation                         | 24 |
| 6.1   | Turning the Hoist ON and OFF            | 24 |
| 6.2   | Raising and lowering the carry bar      | 24 |
| 6.3   | Moving the Hoist along the track system | 25 |
| 6.4   | Handset Storage                         | 25 |
| 6.5   | Charging the Hoist                      | 25 |
| 6.5.1 | Handset Charging                        | 25 |
| 6.6   | Emergency Operation                     | 26 |
| 6.6.1 | Emergency stopping                      | 26 |
| 6.6.2 | Emergency lowering                      | 27 |
| 7.0   | Technical Specification                 | 28 |
| 7.1   | Hoist Dimensions and Lifting Range      | 28 |
| 7.2   | Specifications                          | 29 |
| 7.3   | Expected Product Lifetime               | 30 |
| 7.4   | Standards Applied                       | 30 |

|        |   |    |
|--------|---|----|
| 8.0    | Environmental - Storage and Operating Conditions..... | 30 |
| 8.1    | Normal operating conditions .....                     | 31 |
| 8.2    | Shipping and storage conditions.....                  | 31 |
| 9.0    | Disposal.....   | 31 |
| 10.0   | Fault Finding.....                                    | 32 |
| 10.1   | LED Display.....                                      | 33 |
| 11.0   | General Inspection, Maintenance and Cleaning.....     | 34 |
| 11.1   | Service.....  | 34 |
| 11.2   | Inspection .....                                      | 34 |
| 11.2.1 | Lift Tape Caution .....                               | 35 |
| 11.3   | Cleaning .....  | 35 |
| 11.3.1 | General Cleaning.....                                 | 35 |
| 11.3.2 | Disinfecting (if necessary) .....                     | 36 |
| 12.0   | Warranty .....  | 37 |
| 13.0   | Service Record History .....                          | 38 |

## 1.0 Safety Instructions and Warnings

### 1.1 Introduction

This manual includes all variants of the CP440P Ceiling Track Hoist, along with all variants for various track types.

Below a list of all track profiles that the CPP can be installed into through the different configurations. The below profiles must match your pre-installed track for the CPP to be installed.



Type 1

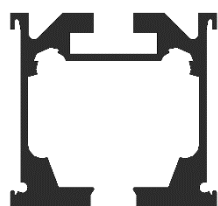

Type 2

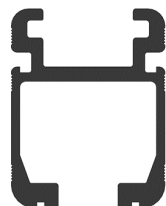

Type 3

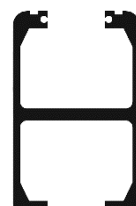

Type 4



Type 5

The list below includes all types of CPP that are covered by this User Manual and which track type they are suitable for.

| Hoist Type          | Carry Bar Type  | Track Type |
|---------------------|-----------------|------------|
| CP440P – 108761     | Black Carry Bar | Type 1     |
| CP440P – 108778     | White Carry Bar | Type 1     |
| CP440P – 108762     | Black Carry Bar | Type 2     |
| CP440P – 108779     | White Carry Bar | Type 2     |
| CP440P – 108763     | Black Carry Bar | Type 3     |
| CP440P – 108780     | White Carry Bar | Type 3     |
| CP440P – 108764     | Black Carry Bar | Type 4     |
| CP440P – 108781     | White Carry Bar | Type 4     |
| CP440P – 108765     | Black Carry Bar | Type 5     |
| CP440P – 108782     | White Carry Bar | Type 5     |
| CP440P FSG – 108766 | Black Carry Bar | FSG        |
| CP440P FSG – 108783 | White Carry Bar | FSG        |

Table 1

As hoisting and transferring a person presents a potential risk, the information in this manual is important to your safety.



Please read and understand this manual in its entirety before using your CPP Hoist.

The information in this manual is important for the safety of anyone near the CPP Hoist and must be read and understood to help prevent injuries. It is also crucial to the proper operation and maintenance of the CPP Hoist.

Store this manual with the documents included with the hoist system and sling(s). The CPP Hoist is designed to be used in conjunction with the hoist track, accessories and slings. Please refer to any user guides supplied with these components while reviewing this manual.

Should any questions arise from reviewing this manual, contact your local authorised representative.

Failure to comply with warnings in this manual may result in; injury to the operator and/or client and/or damage to the Hoist or related components.

Contents of this manual are subject to change without prior notice.



Do not attempt to use this equipment without first understanding the contents of this manual.



Unauthorised modifications on any Mackworth product may affect its safety. The manufacturer will not be held responsible for any accident, incident or deficiencies of performance that occur as a result of any unauthorised modification to its products.

## 1.4 Symbols Used

The table below includes all symbols from BS EN ISO 15223-1:2016 that can be found in this manual and on the product and what they represent. Refer back to this table when you are unsure of what a symbol represents.



















|   |   |   |   |
|---|---|---|---|
|    | Consult instructions before use   |    | Caution – see instructions for use  |
|    | Class II Equipment - electrical equipment in which protection against electric shock does not rely on basic insulation only | <b>SWL</b>  | Safe Working Load represents the maximum load rated for safe operation  |
|    | Manufacturer  |    | Date of manufacture   |
|   | Packaging indicator – This way up   |    | Packaging indicator – Keep dry  |
|  | Serial number   |  | For internal use only   |
|  | Please observe local laws on recycling  | <b>IP<sub>N<sub>1</sub></sub>N<sub>2</sub></b>                                      | Degree of protection provided by enclosure.<br>N <sub>1</sub> : Ingress of particles<br>N <sub>2</sub> : Ingress of water |
|  | Temperature range   |  | Humidity range  |
|  | Atmospheric pressure range  |  | Type 'B' applied part   |
|  | Catalogue number  |  | Type 'BF' applied part  |
|  | UK CA   |  | European Authorised Representative  |

Table 2

## 1.5 Contraindications/Limitations

There are no known “contraindications” associated with the usage of the CPP hoist and its accessories, provided they are used as per manufacturer’s recommendations and guidelines. However, it is recommended that a client specific assessment is completed by a trained and knowledgeable health care professional to determine the method of transfer.

Mackworth does not recommend a required number of care givers for the use of our products. This information and recommendation can only be provided after a thorough personalized, case specific assessment, as there are many factors that can influence these decisions.

## 1.6 Intended Use



For internal use only.

This manual covers the variants of the CP440P Ceiling Track Hoists, along with all variants for various track types.

**All models of CP440P found in Table 1 have a Safe Working Load (SWL) of 200kg (440lb).**

With a safe working load of 200kg (440lb), the CPP Hoist is a raising and lowering aid used to transfer people safely. The Hoist makes it possible to move mobility impaired individuals with minimal strain or risk to the caregiver, while providing complete safety, dignity and comfort for the person being moved.

The easy to use hoist is designed to be operated by both professional health care workers and home health care workers who may not have a specific range of skills in health care. Typical home care users may include, but is not limited to, teachers, medics, paramedics, carers, family and friends. Focusing on the dignity and wellbeing of the person being moved, the simple to use hoist maximises the amount of care provided to the person.

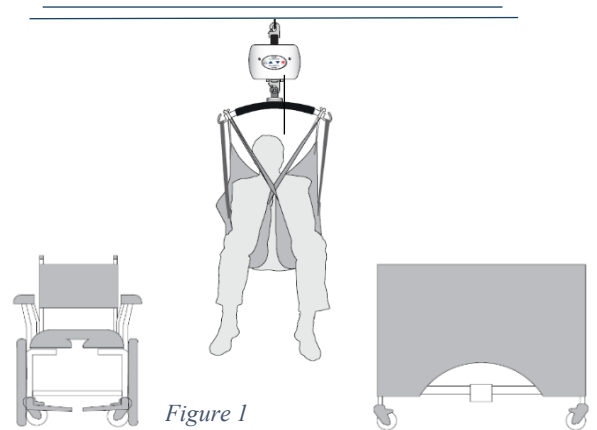

The CPP Hoist is a ceiling track hoist and should only be used whilst on the ceiling track. It has the ability to raise up an individual from one location, such as a bed, move the individual along the track to another location and finally lower the individual, such as into a chair or a bath.

The CPP is intended to be used with Mackworth and Care-ability slings, a Mackworth clipped carry bar and the ceiling track system or Free Standing Gantry. Together these three items make up the system. Please refer to any user guides supplied with the sling and track system and reference them while reviewing this manual.



A risk assessment must be performed before using any other manufactured sling, carry bar or ceiling track to ensure ‘safe’ use can be established.

The device is used under instruction and the operation of the aid is undertaken by a trained carer.

The carry bar is manufactured by Mackworth, associated for use with this device, incorporates three fixing point options at either end of carry bar, with a safety retaining clip on the outer hook. The fixing can be derived by the user, by means of a simple connection loop, made by the sling, to the carry bar. This connection system is used throughout the industry in various designs but all acts as the means to hold the sling and user in place through operation of the device whilst in use.

The sling is a specially designed fabric accessory that attaches to the hoist by means of a carry bar and strap system, and holds an individual while the hoist or transfer takes place. The sling is supplied separately from the hoist at the initial time of purchase.

The track, also supplied separately from the hoist at the time of purchase, is the means to operate the hoist in a defined safe route, enabling the person different uses around the “travel” of the hoist.

If additional accessories have been supplied with the hoist, refer to the instructions included with those items.

- The CPP Hoist must be installed on the ceiling track prior to use.
- The CPP Hoist must be installed only by persons authorized by Mackworth who have had the training to do so.
- The CPP can be removed from the track using the provided reacher pole, this action must only be performed by an approved trained professional.
- Under no circumstance should the CPP Hoist, track, sling or entire system be put in control of a person who has not been properly trained in the use and care of this equipment. Failure to adhere to this warning may result in serious injury to the operator, and / or the individual being hoisted / transferred.
- In facilities where more than one operator will be responsible for using the CPP Hoist and associated systems and sling(s) it is imperative that all such members be trained in the hoist's proper use. A training program should be established by the facility to acquaint new operators with this equipment.
- Your guarantee is void if any modifications are made that are not authorised by Mackworth. This includes, but is not limited to, shortening the length of the emergency red cord – for example, tying it up or cutting it.
- The CPP Hoist, and associated track and sling are not toys. Do not use it for unsafe practices. Do not allow children to play with the hoist or any of its components.
- There are no user serviceable parts inside the cover of the hoist, likewise for any components of the associated parts. Do not remove cover screws, or open the hoist unit, as this will VOID THE GUARANTEE/WARRANTY.
- Never expose the CPP hoist directly to water. Your guarantee does not cover any misuse or abuse of the hoist system.
- To maintain optimum function, the CPP hoist should be inspected and maintained on a regular basis. See section 'General Inspection, Maintenance and Cleaning' within this user manual.
- Any accessories used with the CPP including track and sling(s), should be checked to ensure that they are in good working order. Check for signs of wear to each component prior to use. Report any unusual wear, or damage immediately to your local authorized dealer.
- The CPP Hoist and associated accessories, track and sling(s) are intended only for hoisting and transferring of a person. Mackworth will not be responsible for any damage caused by the misuse, neglect or purposeful destruction of the Hoist, and/or its associated components.
- The installation of the Hoist and its associated parts are certified to a maximum load of 200kg. Do not exceed the maximum rated load of any of the components.
- There is a risk of explosion if the Hoist is used in the presence of flammable anaesthetics.
- Ensure that a clear space is maintained around the Hoist and track. Before performing a transfer check for and move all obstacles out of the way.
- Your Hoist is for human hoisting. Do not use it, or allow it to be used, for any other purpose.
- Protecting the people present, visually monitor sling loop connection points during raising, lowering and transfer stages so the sling remains firmly attached to the carry bar.
- In areas where children are prone to be present be vigilant when operating the Hoist.
- The Hoist batteries are not a user serviceable part. Contact your local authorised dealer to arrange for replacement.



- To reduce the risk of unintended use, when the Hoist is not in use remove the sling(s) from the product to prevent entrapment or strangulation should the device be tampered with.
- Between the Hoist, Carry Bar, Sling and other accessories, the lowest maximum load shall always be used.
- Before initial use, the hoist unit must be charged for approximately 8 hours. Refer to section 'Charging the Hoist'. The handset must also be connected to the hoist. To connect the handset refer to the section 'Connecting the Handset to the Hoist'.
- The Hoist is only to be removed by an approved trained professional.



You may need to seek specialist advice on how to assist some people with specific moving and handling needs. Sources of advice include, but is not limited to, professional bodies and organisations, occupational therapist, physiotherapists, manual handling advisers and ergonomist with experience in health and social care.

## 1.7 Additional Warnings and Safety Notices



**Risk of strangulation:** Please make sure handset cable and lift tape are clear of all persons at all times.

**Risk of impact with carry bar:** Please take care to ensure the carry bar is clear of the person in the sling when preparing to raise/lower and move them to avoid any contact with that person.

**Risk of collision:** The person operating the hoist should make sure that when raising, lowering or moving the Hoist that no people or objects will obstruct, be injured or damaged by the movement.

**Serious Injury:** If, during the use of this device or as a result of its use a serious incident has occurred, please report it to the manufacturer and to your national authority.

**Electric Shock:** Do not insert any objects into the hoist case or battery charging station because of potential risk of electric shock.

To reduce the risk of electric shock, do not install or operate the battery charger with a damaged cable or if the unit has been dropped or damaged.

**Portable RF Communication Devices:** Portable RF communications equipment (including peripherals, such as antenna cables and external antenna) should be used no closer than 30cm (12 inches) to any part of the CPP Hoist, including cables specified by the manufacturer, otherwise degradation of the performance of this equipment could result

**Vicinity to Other Equipment:** Use of this equipment adjacent to or stacked with other equipment should be avoided, as it could result in improper operation. If such use is necessary, this equipment and the other equipment should be observed to verify that they are operating normally.

**Specified Accessories:** Use of accessories, transducers and cables other than those specified or provided by the manufacturer of this equipment could result in increased electromagnetic emissions or decreased electromagnetic immunity of this equipment and result in improper operation.

## 1.8 Operating Environment

The CPP Hoist is suitable for use within the professional health care facility environment as well as the home health care environment.

The Hoist is not suitable for any special environments.

The Hoist is not intended to be used in environments where there are rapid changes in the environmental temperature and humidity during intended use.

## 1.9 Essential Performance

The essential performance of the Hoist is defined as:

Raise up, lower down, traverse left, and traverse right and emergency lower.

These functions may be interrupted if the hoist is subjected to any electromagnetic field created by other electrical devices which are located nearby.

In the event of electromagnetic disturbances, the following conditions may occur:

1. Should the LED Notification panel Display go blank, or become unreadable, but eventually self recovers and there is detrimental effect to performance, continue to use but investigate source of electromagnetic disturbance.
2. Should the LED Notification panel Display go blank, or the charging status LED's continue to flash red or green, the hoist is still acceptable to be used, but investigate EMC source and contact your service provider at the soonest opportunity.
3. Should the lift or lower function pause temporarily during use, the hoist can continue to be used but investigate EMC source and contact your service provider at the earliest convenience.

## 1.10 EMC Statement

The following statement has been made against the assumption that the user of the system utilises the provided components supplied by the manufacturer of the device to operate the device as intended. DO NOT use any other form of power charge with the system as the manufacturer's adapter has been assessed and complies with the EMC requirements.

This product, manufactured by Mackworth, has been designed, manufactured and tested in accordance with the legal requirements for the environment in which the device will be used within.

Pacemakers, defibrillators and other medical devices should be manufactured in such a manner that they can withstand Electromagnetic Interferences (EMI) in accordance with their associated mandatory European directives and regulations. Please consult the user alert card which would have been issued to the user regarding the use of electrical items for those individuals fitted with these or any other devices.

If users of this equipment are unsure of its compliance to EMC you can request the confirmation from Mackworth that the product is manufactured to the appropriate Electromagnetic Compatibility standard.

A brief summary of the tests carried out in accordance with IEC 60601-1-2 is shown below in Table 3.

The hoist is also classified as Class B according to CISPR 11:2009 for the home health care environment.

The use of the device within the correct area where the intended use is given will have no detrimental effect on other devices that have been tested to their intended respective requirements.

| Section   | Specification Clause | Test Description   | Results | Comments/ Base Standard |
|---|----------------------|--|---------|-------------------------|
| <b>Configuration and Mode: Test setup standby</b> |                      |  |         |                         |
| <b>2.1</b>  | 4.4.1                | General Requirement; Risk Management Process for ME Equipment and ME Systems | Pass    |                         |
| <b>2.2</b>  | 5                    | Identification, Marking and documents  | Pass    |                         |

| Configuration and Mode: Test setup charging               |         |  |      |   |
|---|---------|--|------|---|
| 2.3   | 7.1.1   | Mains Terminal Disturbance Voltage   | Pass | CISPR 11: 2009 A1:2010 EN 55016-2-3: 2004 + A1:2005 |
| 2.4   | 7.1.1   | Electromagnetic Radiation Disturbance  | Pass | CISPR 11: 2009 A1:2010 EN 55016-2-3: 2004 + A1:2005 |
| 2.5   | 7.2.1   | Harmonic Current Emissions (AC Power Port)   | Pass | EN 61000-3-2: 2014                                  |
| 2.6   | 7.2.2   | Voltage Fluctuations and Flicker (AC Power Port)                                       | Pass | IEC 61000-3-3: 2013                                 |
| 2.7   | Table 4 | Immunity to Electrostatic discharge (Enclosure Port)                                   | Pass | IEC 61000-4-2 2008                                  |
| 2.8   | Table 4 | Immunity to Radiated RF Electromagnetic fields (Enclosure Port)                        | Pass | IEC 61000-4-3: 2006 A2:2010                         |
| 2.9   | Table 4 | Immunity to Proximity Fields from RF Wireless CommunicatioN Equipment (Enclosure Port) | Pass | IEC 61000-4-3: 2006 A2:2010                         |
| 2.10  | Table 5 | Immunity to Surges (AC Power Port)   | Pass | IEC 61000-4-5: 2005                                 |
| 2.11  | Table 5 | Immunity to Electrical Fast Transient / Burst (AC Power Port)                          | Pass | IEC 61000-4-4: 2012                                 |
| 2.12  | Table 5 | Immunity to Conduct Disturbances Induced by RF Fields (AC Power Port)                  | Pass | IEC 61000-4-6: 2013                                 |
| 2.13  | Table 5 | Immunity to Voltage Dips and Voltage Variations (AC Power Port)                        | Pass | IEC 61000-4-11: 2004                                |
| 2.14  | Table 5 | Immunity to Voltage Interruptions (AC Power Port)                                      | Pass | IEC 61000-4-11: 2004                                |
| In-Track charging system stand testing                    |         |  |      |   |
| 2.7   | Table 4 | Immunity to Electrostatic discharge (Enclosure Port)                                   | Pass | IEC 61000-4-2 2008                                  |
| Configuration and Mode: Test setup standby                |         |  |      |   |
| 2.4   | 7.1.1   | Electromagnetic Radiation Disturbance  | Pass | CISPR 11: 2009 A1:2010 EN 55016-2-3: 2004 + A1:2005 |
| 2.7   | Table 4 | Immunity to Electrostatic discharge (Enclosure Port)                                   | Pass | IEC 61000-4-2 2008                                  |
| 2.8   | Table 4 | Immunity to Radiated RF Electromagnetic fields (Enclosure Port)                        | Pass | IEC 61000-4-3: 2006 A2:2010                         |
| 2.9   | Table 4 | Immunity to Proximity Fields from RF Wireless CommunicatioN Equipment (Enclosure Port) | Pass | IEC 61000-4-3: 2006 A2:2010                         |
| Configuration and Mode: Test set up operating up and down |         |  |      |   |
| 2.4   | 7.1.1   | Electromagnetic Radiation Disturbance  | Pass | CISPR 11: 2009 A1:2010 EN 55016-2-3: 2004 + A1:2005 |
| 2.7   | Table 4 | Immunity to Electrostatic discharge (Enclosure Port)                                   | Pass | IEC 61000-4-2 2008                                  |
| 2.8   | Table 4 | Immunity to Radiated RF Electromagnetic fields (Enclosure Port)                        | Pass | IEC 61000-4-3: 2006 A2:2010                         |
| 2.9   | Table 4 | Immunity to Proximity Fields from RF Wireless CommunicatioN Equipment (Enclosure Port) | Pass | IEC 61000-4-3: 2006 A2:2010                         |
| Configuration and Mode: Test setup standby                |         |  |      |   |
| 2.1   | 4.4.1   | General Requirement; Risk Management Process for ME Equipment and ME Systems           | Pass |   |
| 2.2   | 5       | Identification, Marking and documents  | Pass |   |

Table 3

## 2.0 Components/Key Parts

Please see below to familiarise yourself with the components of the Mackworth CPP Hoist. The images below show the contents of the Hoist. If you have not received all the components contact your local Mackworth dealer immediately – contact details are provided on the last page of this manual.

| Item | Description   | Part Numbers                    |
|------|---------------|---------------------------------|
| 1    | CPP Hoist     | See Table 1:                    |
| 2    | Carry bar     | 300501, 300512                  |
| 3    | Handset       | 108032                          |
| 4    | Hoist charger | 104037                          |
| 5    | Trolley       | 108060, 108130, 108120, 108220, |
| 6    | Reacher Pole  | 430046                          |
| 7    | User manual   | 999086                          |

Table 4



Figure 1

### 2.1 Unpacking



The Hoist will arrive to you in a robust box, please be careful when removing the components from the box. Please read the user guide in full before operating.

This user manual should be kept safe for future reference.

The Hoist has been specifically designed to be installed in both the professional and home health care environments.

No matter the environment, health and safety factors should be considered to ensure the safety and essential performance of the Hoist and to avoid unnecessary damage or injuries to people within the area of the Hoist.



When using a sharp knife, be careful not to damage the product.

This section will summarize the layout of the hoist packaging and what is included in the Box. It is recommended a knife is used for smoother unpacking of the hoist. The hoist is packed into a single box (280x670x365), weighing approximately 11kg.

Using a knife to open the box around the perimeter, the box should open, remove the internal packaging to access the product. It will include all the components listed above.

Please see below to familiarise yourself with the components of the CPP hoist. The images below show the contents of the hoist package. If you have not received all the components contact your local Mackworth dealer immediately – contact details are provided on the last page of this manual.



Figure 3



Figure 4

### 3.0 Installation

The CPP Hoist has been specifically designed to be installed in both the professional and home health care environments.

No matter the environment, health and safety factors should be considered to ensure the safety and essential performance of the hoist and to avoid unnecessary damage or injuries to people within the area of the hoist.

Typical examples include radiated heat (e.g. from a heater or fireplace), excessive moisture impacting electrical performance (e.g. from a bathroom or kitchen area) and the correct storage of the hoist after use (e.g. handset position on the carry bar).

The Hoist is not intended to be used in environments where there are rapid changes in the environmental temperature and humidity during intended use.

This manual covers the safety and advice for the CPP and moving and handling risks can be done in-house, as long as the person is competent to identify and address the risks.

The CPP is a ceiling track hoist that can be removed from one track system to another, using the provided reacher pole, this action must only be performed by an approved trained professional.

Refer to the Commissioning guide document which outlines the correct procedure to install the product.  
Document Number: 996086.

You may need to seek to seek specialist advice on how to assist some people with specific moving and handling needs. Sources of advice include, but is not limited to, professional bodies and organisations, occupational therapist, physiotherapists, manual handling advisers and ergonomist with experience in health and social care.



A Mackworth approved trained professional must install the hoist.

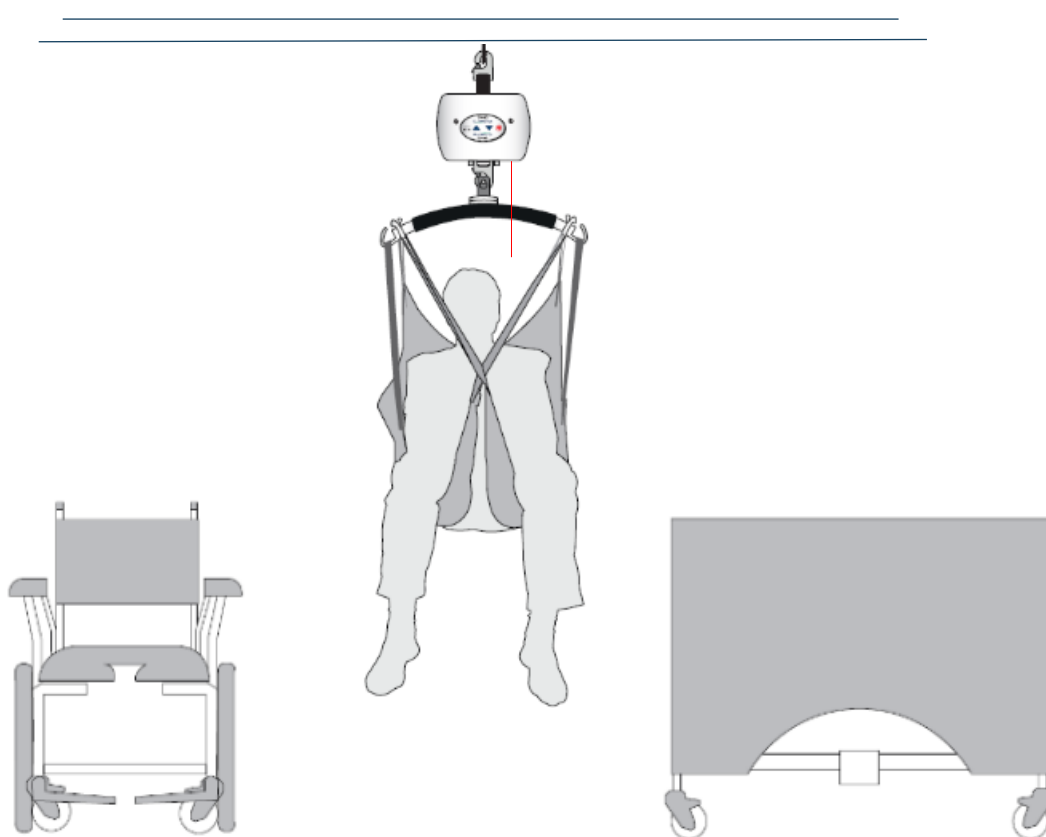
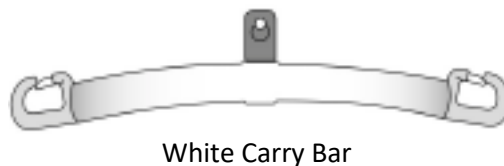

Figure 5

## 4.0 Type 'BF' Applied parts

Below shows the two parts of the hoisting system, which are classed as Body Floating (BF) applied parts. The carry bar is a complete assembled unit which allows approved Mackworth slings to be attached, to lift and assist patient. See section 5.1 for instructions to attach carry bar to Hoist system and 5.2 to attach an approved sling to the carry bar. To see Mackworth approved sling list, see table 5 and 6.



Slings  
(Reference image)

## 5.0 Frequently Used Functions

### 5.1 Carry Bar

Attach the carry bar (type 'BF applied part) into the hook on the lift tape, located at the end opposite to the hoist, in the following way:

1. On the hook, move the locking mechanism into the hook by pressing down on the tab (Figure 6 and 7).
2. With the carry bar positioned sideways along the length of the bar, move the pin at the top of the carry bar into the hook (Figure 8).
3. Alternatively, with the carry bar positioned sideways, the pin at the top of the carry bar can gently push the locking mechanism out of the way as the pin is carefully moved into the hook.
4. Once the pin is in the hook, rotate the carry bar 90° down so the carry bar is hanging below the hook on the pin in the hook. Move the locking mechanism into place by pushing up on the tab, securing the carry bar on the hook and lifting tape. (Figure 10 and 11)



Figure 6



Figure 7

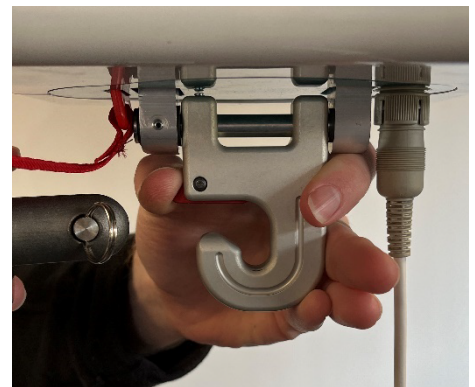

Figure 8



Figure 9



Figure 10



Figure 11

The black and white carry bar are both attached to the Quick Release Hook (QRS) in the same fashion as described above, see images below for reference.

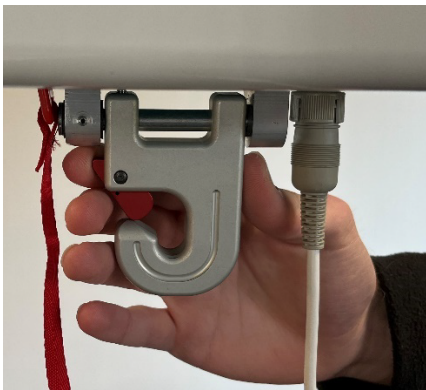

Figure 12



Figure 13



Figure 14



Figure 15



Figure 16



Figure 17

## 5.2 Slings

The way the sling is attached to the carry bar needs to be assessed on individual basis and documented in the individual's care plan. Furthermore, the person attaching the sling to the carry bar should reference the user manual for the specific sling in use as attachment points vary depending on the application and type.

Only after the correct attachment is fully understood should the sling loops be fitted onto the carry bar in the correct order. Sling loops should be attached as follows:

1. Put the required sling loop onto your finger and thumb and then using the same finger or thumb, pull back the spring locking mechanism on the correct hook on the correct side of the carry bar (Figure 18).
2. Slide the sling loop from your finger and thumb over the edge of the hook (Figure 19 and 20).
3. After positioning the loop below the locking mechanism (Figure 21) release the spring locking mechanism to secure the sling loop. (Figure 22)



Make sure the required loop(s) are on the correct hooks and are correctly positioned.



Figure 18



Figure 19

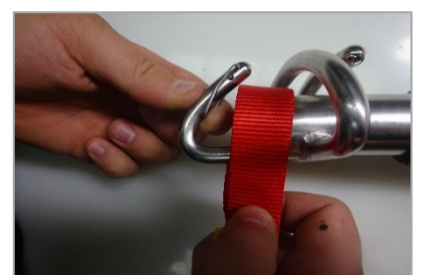

Figure 20



Figure 21



Figure 22

To remove the sling, simply reverse the process – pull back on the spring locking mechanism, lift the loop out of the hook and release the locking mechanism.

The slings attach to the black and white carry bar in the same fashion as described above, see images below for reference.



Figure 23



Figure 24



Figure 25

We recommend the use of Mackworth manufactured sling range (type 'BF' applied part) to be utilised with the CPP Hoist. It is at the user's discretion to use alternative supplied product. In utilising another manufacturer's sling, checks must first be made to ensure the sling is safe to use and meets the requirements of BS EN ISO 10535 before its use and a full risk assessment to be carry out before use.

The Mackworth slings with a safe working load of 200kg (440lb) or more that can be used with the CPP Hoist are shown below in Table 5, complete with product codes.

| Size                                   | Mackworth Sling Range - Product Material and Code |                |            |            |                  |
|--|---|----------------|------------|------------|------------------|
|  | Polyester Solid                                   | Polyester Mesh | Parasilk   | Quilted    | Supersoft Spacer |
| <b>Mackworth Oak</b>                   |   |                |            |            |                  |
| <b>Small</b>                           | 1201OK7500  | 1201OK8500     | 1201OK3500 | 1201OK5500 | 1201OK4500       |
| <b>Medium</b>                          | 1201OK7400  | 1201OK8400     | 1201OK3400 | 1201OK5400 | 1201OK4400       |
| <b>Large</b>                           | 1201OK7300  | 1201OK8300     | 1201OK3300 | 1201OK5300 | 1201OK4300       |
| <b>XL</b>                              | 1201OK7200  | 1201OK8200     | 1201OK3200 | 1201OK5200 | 1201OK4200       |
| <b>XXL</b>                             | 1201OK7100  | 1201OK8100     | 1201OK3100 | 1201OK5100 | 1201OK4100       |
| <b>XXXL</b>                            | 1201OK7000  | 1201OK8000     | 1201OK3000 | 1201OK5000 | 1201OK4000       |
| <b>Mackworth Oak with head support</b> |   |                |            |            |                  |
| <b>Small</b>                           | 1201OK7520  | 1201OK8520     | 1201OK3520 | 1201OK5520 | 1201OK4520       |
| <b>Medium</b>                          | 1201OK7420  | 1201OK8420     | 1201OK3420 | 1201OK5420 | 1201OK4420       |
| <b>Large</b>                           | 1201OK7320  | 1201OK8320     | 1201OK3320 | 1201OK5320 | 1201OK4320       |
| <b>XL</b>                              | 1201OK7220  | 1201OK8220     | 1201OK3220 | 1201OK5220 | 1201OK4220       |
| <b>XXL</b>                             | 1201OK7120  | 1201OK8120     | 1201OK3120 | 1201OK5120 | 1201OK4120       |
| <b>XXXL</b>                            | 1201OK7020  | 1201OK8020     | 1201OK3020 | 1201OK5020 | 1201OK4020       |



| Mackworth Yew                      |            |  |            |            |            |
|------------------------------------|------------|--|------------|------------|------------|
| Small                              | 1201YW7500 | 1201YW8500   | 1201YW3500 | n/a        | 1201YW4500 |
| Medium                             | 1201YW7400 | 1201YW8400   | 1201YW3400 | n/a        | 1201YW4400 |
| Large                              | 1201YW7300 | 1201YW8300   | 1201YW3300 | n/a        | 1201YW4300 |
| XL                                 | 1201YW7200 | 1201YW8200   | 1201YW3200 | n/a        | 1201YW4200 |
| XXL                                | 1201YW7100 | 1201YW8100   | 1201YW3100 | n/a        | 1201YW4100 |
| XXXL                               | 1201YW7000 | 1201YW8000   | 1201YW3000 | n/a        | 1201YW4000 |
| Mackworth Yew with head support    |            |  |            |            |            |
| Small                              | 1201YW7520 | 1201YW8520   | 1201YW3520 | n/a        | 1201YW4520 |
| Medium                             | 1201YW7420 | 1201YW8420   | 1201YW3420 | n/a        | 1201YW4420 |
| Large                              | 1201YW7320 | 1201YW8320   | 1201YW3320 | n/a        | 1201YW4320 |
| XL                                 | 1201YW7220 | 1201YW8220   | 1201YW3220 | n/a        | 1201YW4220 |
| XXL                                | 1201YW7120 | 1201YW8120   | 1201YW3120 | n/a        | 1201YW4120 |
| XXXL                               | 1201YW7020 | 1201YW8020   | 1201YW3020 | n/a        | 1201YW4020 |
| Mackworth Hazel                    |            |  |            |            |            |
| Small                              | 1201HZ7500 | 1201HZ8500   | 1201HZ3500 | 1201HZ5500 | 1201HZ4500 |
| Medium                             | 1201HZ7400 | 1201HZ8500   | 1201HZ3400 | 1201HZ5400 | 1201HZ4400 |
| Large                              | 1201HZ7300 | 1201HZ8300   | 1201HZ3300 | 1201HZ5300 | 1201HZ4300 |
| XL                                 | 1201HZ7200 | 1201HZ8200   | 1201HZ3200 | 1201HZ5200 | 1201HZ4200 |
| XXL                                | 1201HZ7100 | 1201HZ8100   | 1201HZ3100 | 1201HZ5100 | 1201HZ4100 |
| XXXL                               | 1201HZ7000 | 1201HZ8000   | 1201HZ3000 | 1201HZ5000 | 1201HZ4000 |
| Mackworth Hazel with head support  |            |  |            |            |            |
| Small                              | 1201HZ7520 | 1201HZ8520   | 1201HZ3520 | 1201HZ5520 | 1201HZ4520 |
| Medium                             | 1201HZ7420 | 1201HZ8520   | 1201HZ3420 | 1201HZ5420 | 1201HZ4420 |
| Large                              | 1201HZ7320 | 1201HZ8320   | 1201HZ3320 | 1201HZ5320 | 1201HZ4320 |
| XL                                 | 1201HZ7220 | 1201HZ8220   | 1201HZ3220 | 1201HZ5220 | 1201HZ4220 |
| XXL                                | 1201HZ7120 | 1201HZ8120   | 1201HZ3120 | 1201HZ5120 | 1201HZ4120 |
| XXXL                               | 1201HZ7020 | 1201HZ8020   | 1201HZ3020 | 1201HZ5020 | 1201HZ4020 |
| Mackworth Willow                   |            |  |            |            |            |
| Small                              | 1201WL7500 | This sling is made up of a single quilted material backed with solid polyester material. |            |            |            |
| Medium                             | 1201WL7400 |  |            |            |            |
| Large                              | 1201WL7300 |  |            |            |            |
| XL                                 | 1201WL7200 |  |            |            |            |
| XXL                                | 1201WL7100 |  |            |            |            |
| XXXL                               | 1201WL7000 |  |            |            |            |
| Mackworth Willow with head support |            |  |            |            |            |
| Small                              | 1201WL7520 | This sling is made up of a single quilted material backed with solid polyester material. |            |            |            |
| Medium                             | 1201WL7420 |  |            |            |            |
| Large                              | 1201WL7320 |  |            |            |            |
| XL                                 | 1201WL7220 |  |            |            |            |
| XXL                                | 1201WL7120 |  |            |            |            |
| XXXL                               | 1201WL7020 |  |            |            |            |
| Mackworth Beech                    |            |  |            |            |            |
| Small                              | 1201BC7500 | 1201BC8500   | 1201BC3500 | 1201BC5500 | 1201BC4500 |
| Medium                             | 1201BC7400 | 1201BC8400   | 1201BC3400 | 1201BC5400 | 1201BC4400 |
| Large                              | 1201BC7300 | 1201BC8300   | 1201BC3300 | 1201BC5300 | 1201BC4300 |
| XL                                 | 1201BC7200 | 1201BC8200   | 1201BC3200 | 1201BC5200 | 1201BC4200 |
| XXL                                | 1201BC7100 | 1201BC8100   | 1201BC3100 | 1201BC5100 | 1201BC4100 |

|  |            |            |            |            |            |
|--|------------|------------|------------|------------|------------|
| <b>XXXL</b>                              | 1201BC7000 | 1201BC8000 | 1201BC3000 | 1201BC5000 | 1201BC4000 |
| <b>Mackworth Beech with head support</b> |            |            |            |            |            |
| <b>Small</b>                             | 1201BC7520 | 1201BC8520 | 1201BC3520 | 1201BC5520 | 1201BC4520 |
| <b>Medium</b>                            | 1201BC7420 | 1201BC8420 | 1201BC3420 | 1201BC5420 | 1201BC4420 |
| <b>Large</b>                             | 1201BC7320 | 1201BC8320 | 1201BC3320 | 1201BC5320 | 1201BC4320 |
| <b>XL</b>                                | 1201BC7220 | 1201BC8220 | 1201BC3220 | 1201BC5220 | 1201BC4220 |
| <b>XXL</b>                               | 1201BC7120 | 1201BC8120 | 1201BC3120 | 1201BC5120 | 1201BC4120 |
| <b>XXXL</b>                              | 1201BC7020 | 1201BC8020 | 1201BC3020 | 1201BC5020 | 1201BC4020 |
| <b>Mackworth Pine</b>                    |            |            |            |            |            |
| <b>Small</b>                             | 1201PN7500 | 1201PN8500 | 1201PN3500 | 1201PN5500 | 1201PN4500 |
| <b>Medium</b>                            | 1201PN7400 | 1201PN8400 | 1201PN3400 | 1201PN5400 | 1201PN4400 |
| <b>Large</b>                             | 1201PN7300 | 1201PN8300 | 1201PN3300 | 1201PN5300 | 1201PN4300 |
| <b>XL</b>                                | 1201PN7200 | 1201PN8200 | 1201PN3200 | 1201PN5200 | 1201PN4200 |
| <b>XXL</b>                               | 1201PN7100 | 1201PN8100 | 1201PN3100 | 1201PN5100 | 1201PN4100 |
| <b>XXXL</b>                              | 1201PN7000 | 1201PN8000 | 1201PN3000 | 1201PN5000 | 1201PN4000 |
| <b>Mackworth Pine with head support</b>  |            |            |            |            |            |
| <b>Small</b>                             | 1201PN7520 | 1201PN8520 | 1201PN3520 | 1201PN5520 | 1201PN4520 |
| <b>Medium</b>                            | 1201PN7420 | 1201PN8420 | 1201PN3420 | 1201PN5420 | 1201PN4420 |
| <b>Large</b>                             | 1201PN7320 | 1201PN8320 | 1201PN3320 | 1201PN5320 | 1201PN4320 |
| <b>XL</b>                                | 1201PN7220 | 1201PN8220 | 1201PN3220 | 1201PN5220 | 1201PN4220 |
| <b>XXL</b>                               | 1201PN7120 | 1201PN8120 | 1201PN3120 | 1201PN5120 | 1201PN4120 |
| <b>XXXL</b>                              | 1201PN7020 | 1201PN8020 | 1201PN3020 | 1201PN5020 | 1201PN4020 |

Table 5

The Care-Ability slings with a safe working load of 200kg or more that can be used with the CPP Hoist are shown below in Table 6, complete with product codes.

| Size                          | Care-Ability Sling Range - Product Material and Code |          |          |           |
|-------------------------------|--|----------|----------|-----------|
|                               | Polyester  | Mesh     | Spacer   | Parachute |
| <b>CA300 Universal</b>        |  |          |          |           |
| <b>P1</b>                     | CA300PP1   | CA300MP1 | CA300SP1 | CA300PAP1 |
| <b>P2</b>                     | CA300PP2   | CA300MP2 | CA300SP2 | CA300PAP2 |
| <b>P3</b>                     | CA300PP3   | CA300MP3 | CA300SP3 | CA300PAP3 |
| <b>P4</b>                     | CA300PP4   | CA300MP4 | CA300SP4 | CA300PAP4 |
| <b>P5</b>                     | CA300PP5   | CA300MP5 | CA300SP5 | CA300PAP5 |
| <b>X Small</b>                | CA300PXS   | CA300MXS | CA300SXS | CA300PXS  |
| <b>Small</b>                  | CA300PS  | CA300MS  | CA300SS  | CA300PAS  |
| <b>Small/Medium</b>           | CA300PSM   | CA300MSM | CA300SSM | CA300PASM |
| <b>Medium</b>                 | CA300PM  | CA300MM  | CA300SM  | CA300PAM  |
| <b>Medium/Large</b>           | CA300PML   | CA300MML | CA300SML | CA300PAML |
| <b>Large</b>                  | CA300PL  | CA300ML  | CA300SL  | CA300PAL  |
| <b>X Large</b>                | CA300PXL   | CA300MXL | CA300SXL | CA300PAXL |
| <b>CA400 Universal Deluxe</b> |  |          |          |           |
| <b>P1</b>                     | CA400PP1   | CA400MP1 | CA400SP1 | CA400PAP1 |
| <b>P2</b>                     | CA400PP2   | CA400MP2 | CA400SP2 | CA400PAP2 |

|  |          |          |          |           |
|--|----------|----------|----------|-----------|
| <b>P3</b>  | CA400PP3 | CA400MP3 | CA400SP3 | CA400PAP3 |
| <b>P4</b>  | CA400PP4 | CA400MP4 | CA400SP4 | CA400PAP4 |
| <b>P5</b>  | CA400PP5 | CA400MP5 | CA400SP5 | CA400PAP5 |
| <b>X Small</b>                                   | CA400PXS | CA400MXS | CA400SXS | CA400PAXS |
| <b>Small</b>                                     | CA400PS  | CA400MS  | CA400SS  | CA400PAS  |
| <b>Small/Medium</b>                              | CA400PSM | CA400MSM | CA400SSM | CA400PASM |
| <b>Medium</b>                                    | CA400PM  | CA400MM  | CA400SM  | CA400PAM  |
| <b>Medium/Large</b>                              | CA400PML | CA400MML | CA400SML | CA400PAML |
| <b>Large</b>                                     | CA400PL  | CA400ML  | CA400SL  | CA400PAL  |
| <b>X Large</b>                                   | CA400PXL | CA400MXL | CA400SXL | CA400PAXL |
| <b>CA500 Toilet Access</b>                       |          |          |          |           |
| <b>P1</b>  | CA500PP1 | CA500MP1 | CA500SP1 | CA500PAP1 |
| <b>P2</b>  | CA500PP2 | CA500MP2 | CA500SP2 | CA500PAP2 |
| <b>P3</b>  | CA500PP3 | CA500MP3 | CA500SP3 | CA500PAP3 |
| <b>P4</b>  | CA500PP4 | CA500MP4 | CA500SP4 | CA500PAP4 |
| <b>P5</b>  | CA500PP5 | CA500MP5 | CA500SP5 | CA500PAP5 |
| <b>X Small</b>                                   | CA500PXS | CA500MXS | CA500SXS | CA500PAXS |
| <b>Small</b>                                     | CA500PS  | CA500MS  | CA500SS  | CA500PAS  |
| <b>Small/Medium</b>                              | CA500PSM | CA500MSM | CA500SSM | CA500PASM |
| <b>Medium</b>                                    | CA500PM  | CA500MM  | CA500SM  | CA500PAM  |
| <b>Medium/Large</b>                              | CA500PML | CA500MML | CA500SML | CA500PAML |
| <b>Large</b>                                     | CA500PL  | CA500ML  | CA500SL  | CA500PAL  |
| <b>X Large</b>                                   | CA500PXL | CA500MXL | CA500SXL | CA500PAXL |
| <b>CA501 Toilet Access with crossover straps</b> |          |          |          |           |
| <b>P1</b>  | CA501PP1 | CA501MP1 | CA501SP1 | CA501PAP1 |
| <b>P2</b>  | CA501PP2 | CA501MP2 | CA501SP2 | CA501PAP2 |
| <b>P3</b>  | CA501PP3 | CA501MP3 | CA501SP3 | CA501PAP3 |
| <b>P4</b>  | CA501PP4 | CA501MP4 | CA501SP4 | CA501PAP4 |
| <b>P5</b>  | CA501PP5 | CA501MP5 | CA501SP5 | CA501PAP5 |
| <b>X Small</b>                                   | CA501PXS | CA501MXS | CA501SXS | CA501PAXS |
| <b>Small</b>                                     | CA501PS  | CA501MS  | CA501SS  | CA501PAS  |
| <b>Small/Medium</b>                              | CA501PSM | CA501MSM | CA501SSM | CA501PASM |
| <b>Medium</b>                                    | CA501PM  | CA501MM  | CA501SM  | CA501PAM  |
| <b>Medium/Large</b>                              | CA501PML | CA501MML | CA501SML | CA501PAML |
| <b>Large</b>                                     | CA501PL  | CA501ML  | CA501SL  | CA501PAL  |
| <b>X Large</b>                                   | CA501PXL | CA501MXL | CA501SXL | CA501PAXL |
| <b>CA502 Toilet Access with head support</b>     |          |          |          |           |
| <b>P1</b>  | CA502PP1 | CA502MP1 | CA502SP1 | CA502PAP1 |
| <b>P2</b>  | CA502PP2 | CA502MP2 | CA502SP2 | CA502PAP2 |
| <b>P3</b>  | CA502PP3 | CA502MP3 | CA502SP3 | CA502PAP3 |
| <b>P4</b>  | CA502PP4 | CA502MP4 | CA502SP4 | CA502PAP4 |
| <b>P5</b>  | CA502PP5 | CA502MP5 | CA502SP5 | CA502PAP5 |
| <b>X Small</b>                                   | CA502PXS | CA502MXS | CA502SXS | CA502PAXS |
| <b>Small</b>                                     | CA502PS  | CA502MS  | CA502SS  | CA502PAS  |
| <b>Small/Medium</b>                              | CA502PSM | CA502MSM | CA502SSM | CA502PASM |

|   |           |          |          |           |
|---|-----------|----------|----------|-----------|
| <b>Medium</b>                                       | CA502PM   | CA502MM  | CA502SM  | CA502PAM  |
| <b>Medium/Large</b>                                 | CA502PML  | CA502MML | CA502SML | CA502PAML |
| <b>Large</b>  | CA502PL   | CA502ML  | CA502SL  | CA502PAL  |
| <b>X Large</b>                                      | CA502PXL  | CA502MXL | CA502SXL | CA502PAXL |
| <b>CA503 Toilet Access with high back</b>           |           |          |          |           |
| <b>P1</b>   | CA503PP1  | CA503MP1 | CA503SP1 | CA503PAP1 |
| <b>P2</b>   | CA503PP2  | CA503MP2 | CA503SP2 | CA503PAP2 |
| <b>P3</b>   | CA503PP3  | CA503MP3 | CA503SP3 | CA503PAP3 |
| <b>P4</b>   | CA503PP4  | CA503MP4 | CA503SP4 | CA503PAP4 |
| <b>P5</b>   | CA503PP5  | CA503MP5 | CA503SP5 | CA503PAP5 |
| <b>X Small</b>                                      | CA503PXS  | CA503MXS | CA503SXS | CA503PAXS |
| <b>Small</b>  | CA503PS   | CA503MS  | CA503SS  | CA503PAS  |
| <b>Small/Medium</b>                                 | CA503PSM  | CA503MSM | CA503SSM | CA503PASM |
| <b>Medium</b>                                       | CA503PM   | CA503MM  | CA503SM  | CA503PAM  |
| <b>Medium/Large</b>                                 | CA503PML  | CA503MML | CA503SML | CA503PAML |
| <b>Large</b>  | CA503PL   | CA503ML  | CA503SL  | CA503PAL  |
| <b>X Large</b>                                      | CA503PXL  | CA503MXL | CA503SXL | CA503PAXL |
| <b>CA503E Toilet Access with high back extensor</b> |           |          |          |           |
| <b>X Small</b>                                      | CA503EPXS | n/a      | n/a      | n/a       |
| <b>Small</b>  | CA503EPS  | n/a      | n/a      | n/a       |
| <b>Medium</b>                                       | CA503EPM  | n/a      | n/a      | n/a       |
| <b>Large</b>  | CA503EPL  | n/a      | n/a      | n/a       |
| <b>X Large</b>                                      | CA503EPXL | n/a      | n/a      | n/a       |
| <b>CA600 Hammock</b>                                |           |          |          |           |
| <b>P1</b>   | CA600PP1  | CA600MP1 | CA600SP1 | CA600PAP1 |
| <b>P2</b>   | CA600PP2  | CA600MP2 | CA600SP2 | CA600PAP2 |
| <b>P3</b>   | CA600PP3  | CA600MP3 | CA600SP3 | CA600PAP3 |
| <b>P4</b>   | CA600PP4  | CA600MP4 | CA600SP4 | CA600PAP4 |
| <b>P5</b>   | CA600PP5  | CA600MP5 | CA600SP5 | CA600PAP5 |
| <b>X Small</b>                                      | CA600PXS  | CA600MXS | CA600SXS | CA600PAXS |
| <b>Small</b>  | CA600PS   | CA600MS  | CA600SS  | CA600PAS  |
| <b>Small/Medium</b>                                 | CA600PSM  | CA600MSM | CA600SSM | CA600PASM |
| <b>Medium</b>                                       | CA600PM   | CA600MM  | CA600SM  | CA600PAM  |
| <b>Medium/Large</b>                                 | CA600PML  | CA600MML | CA600SML | CA600PAML |
| <b>Large</b>  | CA600PL   | CA600ML  | CA600SL  | CA600PAL  |
| <b>X Large</b>                                      | CA600PXL  | CA600MXL | CA600SXL | CA600PAXL |
| <b>CA700 Classic Hammock</b>                        |           |          |          |           |
| <b>P1</b>   | CA700PP1  | CA700MP1 | CA700SP1 | CA700PAP1 |
| <b>P2</b>   | CA700PP2  | CA700MP2 | CA700SP2 | CA700PAP2 |
| <b>P3</b>   | CA700PP3  | CA700MP3 | CA700SP3 | CA700PAP3 |
| <b>P4</b>   | CA700PP4  | CA700MP4 | CA700SP4 | CA700PAP4 |
| <b>P5</b>   | CA700PP5  | CA700MP5 | CA700SP5 | CA700PAP5 |
| <b>X Small</b>                                      | CA700PXS  | CA700MXS | CA700SXS | CA700PAXS |
| <b>Small</b>  | CA700PS   | CA700MS  | CA700SS  | CA700PAS  |
| <b>Small/Medium</b>                                 | CA700PSM  | CA700MSM | CA700SSM | CA700PASM |

|   |            |            |            |             |
|---|------------|------------|------------|-------------|
| <b>Medium</b>   | CA700PM    | CA700MM    | CA700SM    | CA700PAM    |
| <b>Medium/Large</b>                                     | CA700PML   | CA700MML   | CA700SML   | CA700PAML   |
| <b>Large</b>  | CA700PL    | CA700ML    | CA700SL    | CA700PAL    |
| <b>X Large</b>  | CA700PXL   | CA700MXL   | CA700SXL   | CA700PAXL   |
| <b>CA701 Deluxe Hammock</b>                             |            |            |            |             |
| <b>P1</b>   | CA701PP1   | CA701MP1   | CA701SP1   | CA701PAP1   |
| <b>P2</b>   | CA701PP2   | CA701MP2   | CA701SP2   | CA701PAP2   |
| <b>P3</b>   | CA701PP3   | CA701MP3   | CA701SP3   | CA701PAP3   |
| <b>P4</b>   | CA701PP4   | CA701MP4   | CA701SP4   | CA701PAP4   |
| <b>P5</b>   | CA701PP5   | CA701MP5   | CA701SP5   | CA701PAP5   |
| <b>X Small</b>  | CA701PXS   | CA701MXS   | CA701SXS   | CA701PAXS   |
| <b>Small</b>  | CA701PS    | CA701MS    | CA701SS    | CA701PAS    |
| <b>Small/Medium</b>                                     | CA701PSM   | CA701MSM   | CA701SSM   | CA701PASM   |
| <b>Medium</b>   | CA701PM    | CA701MM    | CA701SM    | CA701PAM    |
| <b>Medium/Large</b>                                     | CA701PML   | CA701MML   | CA701SML   | CA701PAML   |
| <b>Large</b>  | CA701PL    | CA701ML    | CA701SL    | CA701PAL    |
| <b>X Large</b>  | CA701PXL   | CA701MXL   | CA701SXL   | CA701PAXL   |
| <b>CA701 Deluxe Hammock with head support</b>           |            |            |            |             |
| <b>P1</b>   | CA701HSPP1 | CA701HSMP1 | CA701HSSP1 | CA701HSPAP1 |
| <b>P2</b>   | CA701HSPP2 | CA701HSMP2 | CA701HSSP2 | CA701HSPAP2 |
| <b>P3</b>   | CA701HSPP3 | CA701HSMP3 | CA701HSSP3 | CA701HSPAP3 |
| <b>P4</b>   | CA701HSPP4 | CA701HSMP4 | CA701HSSP4 | CA701HSPAP4 |
| <b>P5</b>   | CA701HSPP5 | CA701HSMP5 | CA701HSSP5 | CA701HSPAP5 |
| <b>X Small</b>  | CA701HSPXS | CA701HSMXS | CA701HSSXS | CA701HSPAXS |
| <b>Small</b>  | CA701HSPS  | CA701HSMS  | CA701HSSS  | CA701HSPAS  |
| <b>Small/Medium</b>                                     | CA701HSPSM | CA701HSMSM | CA701HSSSM | CA701HSPASM |
| <b>Medium</b>   | CA701HSPM  | CA701HSMM  | CA701HSSM  | CA701HSPAM  |
| <b>Medium/Large</b>                                     | CA701HSPML | CA701HSMML | CA701HSSML | CA701HSPAML |
| <b>Large</b>  | CA701HSPL  | CA701HSML  | CA701HSSL  | CA701HSPAL  |
| <b>X Large</b>  | CA701HSPXL | CA701HSMXL | CA701HSSXL | CA701HSPAXL |
| <b>CA702 Comfort In Chair Hammock</b>                   |            |            |            |             |
| <b>P1</b>   | CA702PP1   | CA702MP1   | CA702SP1   | CA702PAP1   |
| <b>P2</b>   | CA702PP2   | CA702MP2   | CA702SP2   | CA702PAP2   |
| <b>P3</b>   | CA702PP3   | CA702MP3   | CA702SP3   | CA702PAP3   |
| <b>P4</b>   | CA702PP4   | CA702MP4   | CA702SP4   | CA702PAP4   |
| <b>P5</b>   | CA702PP5   | CA702MP5   | CA702SP5   | CA702PAP5   |
| <b>X Small</b>  | CA702PXS   | CA702MXS   | CA702SXS   | CA702PAXS   |
| <b>Small</b>  | CA702PS    | CA702MS    | CA702SS    | CA702PAS    |
| <b>Small/Medium</b>                                     | CA702PSM   | CA702MSM   | CA702SSM   | CA702PASM   |
| <b>Medium</b>   | CA702PM    | CA702MM    | CA702SM    | CA702PAM    |
| <b>Medium/Large</b>                                     | CA702PML   | CA702MML   | CA702SML   | CA702PAML   |
| <b>Large</b>  | CA702PL    | CA702ML    | CA702SL    | CA702PAL    |
| <b>X Large</b>  | CA702PXL   | CA702MXL   | CA702SXL   | CA702PAXL   |
| <b>CA702 Comfort In Chair Hammock with head support</b> |            |            |            |             |
| <b>P1</b>   | CA702HSPP1 | CA702HSMP1 | CA702HSSP1 | CA702HSPAP1 |

|   |            |            |            |             |
|---|------------|------------|------------|-------------|
| <b>P2</b>                               | CA702HSPP2 | CA702HSMP2 | CA702HSSP2 | CA702HSPAP2 |
| <b>P3</b>                               | CA702HSPP3 | CA702HSMP3 | CA702HSSP3 | CA702HSPAP3 |
| <b>P4</b>                               | CA702HSPP4 | CA702HSMP4 | CA702HSSP4 | CA702HSPAP4 |
| <b>P5</b>                               | CA702HSPP5 | CA702HSMP5 | CA702HSSP5 | CA702HSPAP5 |
| <b>X Small</b>                          | CA702HSPXS | CA702HSMXS | CA702HSSXS | CA702HSPAXS |
| <b>Small</b>                            | CA702HSPS  | CA702HSMS  | CA702HSSS  | CA702HSPAS  |
| <b>Small/Medium</b>                     | CA702HSPSM | CA702HSMSM | CA702HSSSM | CA702HSPASM |
| <b>Medium</b>                           | CA702HSPM  | CA702HSMM  | CA702HSSM  | CA702HSPAM  |
| <b>Medium/Large</b>                     | CA702HSPML | CA702HSMML | CA702HSSML | CA702HSPAML |
| <b>Large</b>                            | CA702HSPL  | CA702HSML  | CA702HSSL  | CA702HSPAL  |
| <b>X Large</b>                          | CA702HSPXL | CA702HSMXL | CA702HSSXL | CA702HSPAXL |
| <b>CA703 Split Leg In Chair Hammock</b> |            |            |            |             |
| <b>P1</b>                               | CA703PP1   | CA703MP1   | CA703SP1   | CA703PAP1   |
| <b>P2</b>                               | CA703PP2   | CA703MP2   | CA703SP2   | CA703PAP2   |
| <b>P3</b>                               | CA703PP3   | CA703MP3   | CA703SP3   | CA703PAP3   |
| <b>P4</b>                               | CA703PP4   | CA703MP4   | CA703SP4   | CA703PAP4   |
| <b>P5</b>                               | CA703PP5   | CA703MP5   | CA703SP5   | CA703PAP5   |
| <b>X Small</b>                          | CA703PXS   | CA703MXS   | CA703SXS   | CA703PAXS   |
| <b>Small</b>                            | CA703PS    | CA703MS    | CA703SS    | CA703PAS    |
| <b>Small/Medium</b>                     | CA703PSM   | CA703MSM   | CA703SSM   | CA703PASM   |
| <b>Medium</b>                           | CA703PM    | CA703MM    | CA703SM    | CA703PAM    |
| <b>Medium/Large</b>                     | CA703PML   | CA703MML   | CA703SML   | CA703PAML   |
| <b>Large</b>                            | CA703PL    | CA703ML    | CA703SL    | CA703PAL    |
| <b>X Large</b>                          | CA703PXL   | CA703MXL   | CA703SXL   | CA703PAXL   |

Table 6

### 5.3 Connecting the Handset to the Hoist



A sturdy ladder or steps may be required in order to access the underside of the Hoist to attach the hand controller. Caution should be used when this is required.

Should the cord that connects the Hoist to the hand controller become disengaged from the underside of the hoist it must be re-connected in order for the Hoist to work.

The hand controller may become disconnected for the following reasons:

- The Hoist is pulled along the track by the hand controller.
- The hand controller cord accidentally gets wrapped around an object while a hoist or transfer is being performed.
- It is accidentally pulled out by the carer or the individual being hoisted.

A connection plug located at the end of the hand controller wire will make the connection to the Hoist via mating together of the male and female sockets from the hand controller to the hoist itself.

To attach the Handset, align the groove circled in the image in the same orientation shown. The groove will be perpendicular to the front face of the Hoist. If the alignment is not perfect, slowly rotate the handset until you feel the plug locating into the socket.

The Electrical handset is connected to a female connector located on the underside of the hoist.

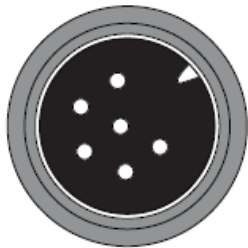

Figure 26

Handset controller connector



Figure 27

Hoist connector



The orientation of the socket pins – this will only fit into the hoist socket in one position – once aligned press the connection home

When the profile of the two mating parts are aligned. Push the handset connector upward into the port until it is fully located. (Figure 28)

To fully secure the handset, twist the threaded lock on the handset connector until it is fully closed. (Figure 29)

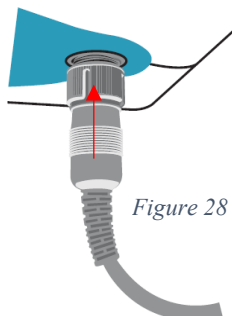

Figure 28

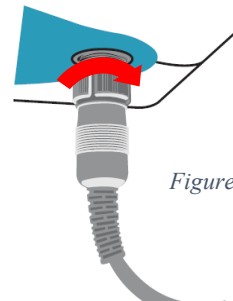

Figure 29

Perform a brief test to ensure proper connectivity. Turn the Hoist ON and OFF and also use the hand controller to raise and lower the carry bar. If these functions all work correctly, then the hand controller is correctly installed to the hoist.

If the Hoist does not work as expected after connection of the hand controller to the device, then please check firstly that the unit has power to operate. This will be indicated by the LED indicator status on the unit.

To remove the handset, follow the procedure above in reverse.

## 6.0 Hoist Operation

### 6.1 Turning the Hoist ON and OFF

To operate the Hoist, it must first be turned ON via the “ON” cord on the Hoist itself (see figure 30). The cord operates a toggle switch within the Hoist. Pressing the toggle switch upward will turn the hoist ON, while pulling the cord down will turn the Hoist OFF. On the side cover of the Hoist, the LED’s will turn GREEN to indicate that power is available. The hand controller will “wake up” once any functionality button is pressed.

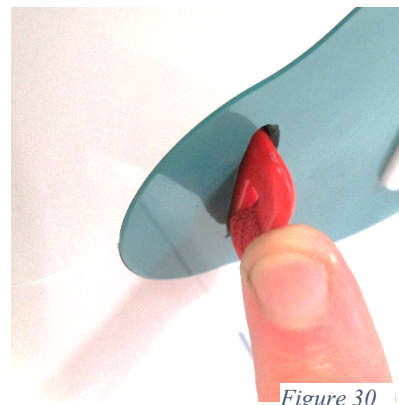

Figure 30

To conserve battery, the Hoist will automatically shut off after approximately two minutes of non-use.

If the batteries of the Hoist are low and require charging, the LED indicator lights located on the hoist will flash yellow (see LED status indications further in the user manual) depending upon the level of discharge and an audible buzzing alarm will sound when the level gets critical until charging takes place.

### 6.2 Raising and lowering the carry bar

By pressing the UP or the DOWN arrow button on the handset, the carry bar can be raised or lowered to the correct height for attaching the sling or positioning an individual. The UP/DOWN functions of the handset buttons are in relation to the travel of the Hoist. That is, the grey button at the top end of the handset activates the UP motion of the carry bar and the Green button activates the DOWN motion (Figure 31). The Red Button is the Emergency Lowering function. This should only be used in an emergency when the normal functions cannot lower the patient during a lift. The Hoist cover also provides these abilities, with the same colour coding performing these functions.

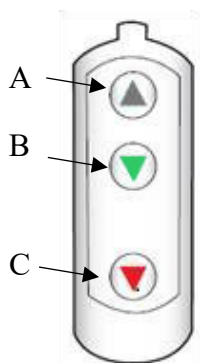

Figure 31

Shown in the image opposite are the 3 functions of the hand controller for the hoist.

- A. “UP” when pressed
- B. “DOWN” when pressed
- C. “EMERGENCY LOWER” when pressed

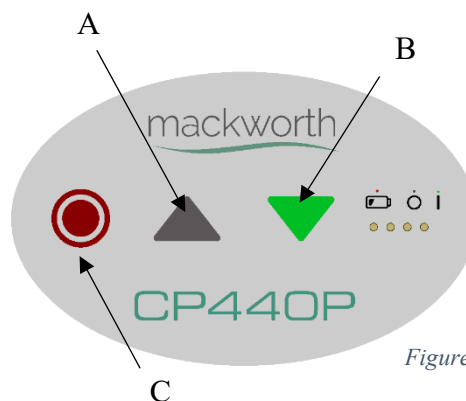

Figure 32



It is recommended that the operator hold the carry bar with one hand while raising/lowering is being done. This will stop the bar accidentally swaying and/or coming into contact with an individual or close object.

For the same reasons, raise the carry bar above head height when not in use and when traversing the unloaded hoist.



## 6.3 Moving the Hoist along the track system



Always use extreme care when moving the hoist along the track. Watch out for and avoid any obstructions that may cause injury to the individual in the sling, damage to the hoist and/or to the obstruction.

After use, the hoist should be located at the correct end of the track system for re-charging.

When needed, the hoist should be moved along the track using the following appropriate method:

To Traverse the hoist, you must first lower the carry bar to an appropriate height to hold onto with both hands.

Then the user must hold the carry bar with both hands either side of the lift tape, and push or pull the hoist along the track in the intended direction of travel to the required destination.

This process applies when moving the Hoist with and without a patient in the sling.

When there is a patient being transferred, ensure they are at a reasonable height above the ground to ensure they are not being dragged along the floor, or hit any obstructions.

Always ensure the direction of travel is clear of any obstacles.



NEVER pull the hoist along the track using the handset as this could have a detrimental effect on the performance of the Hoist.

## 6.4 Handset Storage

The handset is stored in the handset case provided. The handset dock will be installed onto the wall at either end of the track system. This dock is also the charging dock for the hoist as it is charged through the handset. To store the handset after use, traverse the hoist back to its charging location and dock the handset into the handset dock. At the end of each use of the hoist, the handset should be returned to the dock.

To place the handset into the dock correctly, the front face of the handset will face the wall with the attachment hook facing away. The handset should slot into the dock nicely. For further details see "Handset Charging". Always ensure that the handset is stored in the correct orientation as shown in the image. This ensures that the handset complies with the standards stated in section 7.4.

The handset can also be stored onto the carry bar as a secondary storage option. Always ensure that the orientation remains the same.



Figure 33



Figure 34

## 6.5 Charging the Hoist

### 6.5.1 Handset Charging

The CPP hoist is designed for handset charging. A charging dock should have been fitted onto the wall nearby, usually at the end of the ceiling track system.

The charging dock is also used as a handset hook, meaning at the end of each use of the hoist, the hoist should be traversed to the charging docks location and the handset should be placed into the charging dock for placement and charging.

This will ensure that the batteries are charged on a regular basis for peak performance and maximum life expectancy. The hoist may remain connected to the charger indefinitely because the hoist has a built-in regulator, removing the danger of overcharging.

To charge the hoist, you must first open the small blue bung at the base of the handset to open the charging port. Then you must place the handset into the charging dock as shown in the figures below. The handset front face will be facing towards the wall with the attachment hook facing away. Slide the handset all the way into the dock and carefully push until the dock has attached to the handset port.

To ensure the Hoist is charging, check the LED's on the Cover are showing, charging or charged.



Figure 35



Figure 36



Figure 37



Figure 38

Use only the charger that was supplied with the hoist or provided as a replacement. Use of any other charger will void all warranties and may cause damage to the hoist.



When Charging has completed, ensure that the Blue rubber bung at the base of the handset is inserted back into the charging port. This ensures that the stated IP compliance of the handset is maintained.

## 6.6 Emergency Operation

### 6.6.1 Emergency stopping

The Hoist unit has an emergency shut-off feature that allows the operator to cut all power from the Hoist.

By pulling the power cord hanging down from the bottom cover of the Hoist, all powered functions of the hoist will cease immediately. (Figure 39)

Once the Emergency Stop has been used, the Hoist unit will need to be reset in order to operate again. Contact your local authorised dealer to reset the hoist – contact details are on the last page of this manual.

Once reset, simply press any button on the handset to resume power.

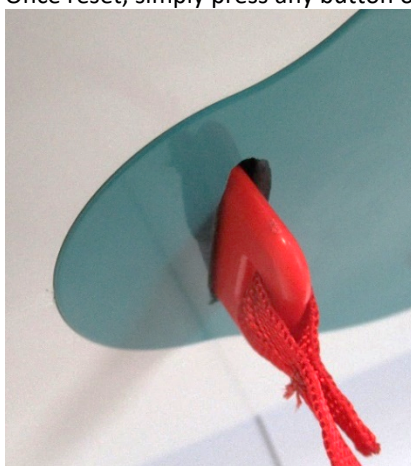

Figure 39

## 6.6.2 Emergency lowering

In the event that the DOWN button on the handset does not function, or in power failure situations, the person may be lowered by Pressing down and HOLDING the red buttons. The emergency button's is located on the handset and also on the Hoist membrane switch panel. (Figure 40 and Figure 41)

Press and hold down on the emergency button (either one which you have chosen) until the person is safely lowered to the desired position. The unit will continue beeping until the red button is released.

NOTE: The emergency lowering function does not provide a lifting function. The Emergency Lower should only be used in an emergency, such as lowering a patient due to damaged handset etc.

Once the emergency button is released, contact your local authorised dealer to report the emergency and where applicable, an approved trained professional may be sent out to solve the issue with the hoist. Do not continue to use the hoist after using the emergency lower function before contacting the local authorised dealer. (See the last page of this manual for contact details).



Figure 40

Emergency Lowering Button



Figure 41

## 7.0 Technical Specification

### 7.1 Hoist Dimensions and Lifting Range

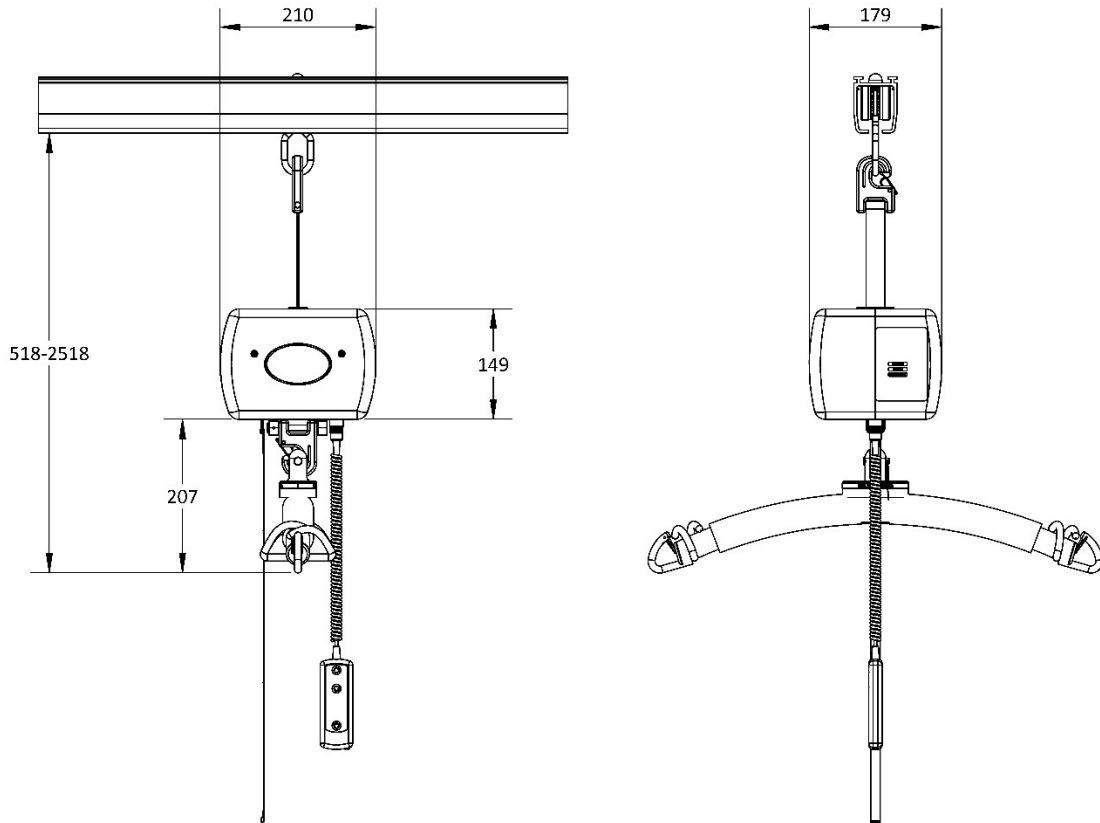

Figure 42

The diagram above (Figure 42) shows the relevant lifting ranges and dimensional sizes of the Hoist. The direction of travel can only be made within the boundaries of where the hoist is in the track system.



There are no necessary modifications required for the device to perform its intended use. However, should the device or the installed system require modification, please consult your local Mackworth dealer to arrange a date and time to assess the required changes to the system.

If this equipment is modified, appropriate inspection and testing must be conducted to ensure continued safe use of the equipment.

## 7.2 Specifications

| Technical specification   |  |
|---|--|
| Hoist Motor   | 24VDC  |
| Charger Input   | 100-240V AC 50/60Hz 1.5A                             |
| Charger Output  | 24VDC/1.0A   |
| Batteries   | 24 V dc (2 x 12V) 3.3Ah Nimh                         |
| Hoist Case  | Flame Retardant ABS                                  |
| Hoist Case Degree of Protection   | IP20   |
| Handset Degree of Protection  | IP24   |
| Lifting Capacity (SWL)  | 200 kg (440 lb)                                      |
| Lifting/Range   | 2100mm (82.7") Lift                                  |
| Operation   | Handset (Electrical)                                 |
| Sound Level   | 54 dB  |
| Lifting Speed (0 kg / 0 lb)   | 30.86 mm/s (1.2 in/s)                                |
| Lifting Speed (50 kg / 110 lb)  | 28.67 mm/s (1.1 in/s)                                |
| Lifting Speed (100 kg / 220 lb)   | 27.66 mm/s (1.1 in/s)                                |
| Lifting Speed (130 kg / 286 lb)   | 25.38 mm/s (1.0 in/s)                                |
| Lifting Speed (200 kg / 440 lb)   | 20.86 mm/s (0.82 in/s)                               |
| Lowering Speed (0 kg / 0 lb)  | 27.02 mm/s (1.06 in/s)                               |
| Lowering Speed (50 kg / 110 lb)   | 34.72 mm/s (1.36 in/s)                               |
| Lowering Speed (100 kg / 220 lb)  | 35.21 mm/s (1.39 in/s)                               |
| Lowering Speed (130 kg / 286 lb)  | 36.04 mm/s (1.41 in/s)                               |
| Lowering Speed (200 kg / 440 lb)  | 37.93 mm/s (1.49 in/s)                               |
| Raising/Lowering Duty Cycle   | 15% use, 85% rest (90 seconds use, 510 seconds rest) |
| Maximum Charging Time   | 8.5 hrs  |
| Battery Capacity – Raising/Lowering (Top 500mm / 19.69" of Lift Tape) – (100 kg / 220 lb) | 120 Lifts  |
| Battery Capacity – Raising/Lowering (Top 500mm / 19.69" of Lift Tape) – (130 kg / 286 lb) | 100 Lifts  |
| Battery Capacity – Raising/Lowering (Top 500mm / 19.69" of Lift Tape) – (200 kg / 440 lb) | 60 Lifts   |

Table 7

| Weights                 |                 |
|-------------------------|-----------------|
| Safe Working Load (SWL) | 200 kg (440 lb) |
| Hoist                   | 4.5 kg (9.9 lb) |
| Battery charger         | 0.5 kg (1.1 lb) |
| Carry bar               | 2kg (4.4 lb)    |
| Handset                 | 0.2kg (0.44 lb) |

Table 8

| Operational Forces                             |      |
|--|------|
| Handset  | 4N   |
| Emergency Button                               | 4N   |
| Hook locking mechanisms on lift tape           | 2.5N |
| Spring clips on carry bar                      | 8N   |
| Manually traversing fully loaded hoist (SWL)   | 97N  |
| Manually traversing unloaded hoist (No weight) | 6N   |

Table 9

### 7.3 Expected Product Lifetime

Ten years depending usage and compliance to maintenance, servicing and LOLER inspections.

Serviceable parts within this period are batteries and the lift tape. Batteries should have an expected service life of >400 discharge cycles, dependant on the charging routine. The lift tape should have an expected service life of 2 years if used correctly but visual inspection should be carried out before use.

### 7.4 Standards Applied

The standards that have been applied to the device are as follows:

- EN 10535:2006 Hoists for the transfer of disabled persons. Requirement and test methods
- EN 60601-1-1:2006 +A12:2014 Medical electrical equipment. General requirements for basic safety and essential performance
- EN 60601-1-2:2015 Medical electrical equipment. General requirements for basic safety and essential performance. Collateral Standard. Electromagnetic disturbances. Requirements and tests
- EN 60601-1-6:2010 Medical electrical equipment. General requirements for basic safety and essential performance
- EN 60601-1-11:2015 Medical electrical equipment. General requirements for basic safety and essential performance

## 8.0 Environmental - Storage and Operating Conditions

The Hoist is intended for internal use within normal environmental conditions.



It is not intended to be used in environments where there are rapid changes in the environmental temperature and humidity during intended use.

- Lint – Due to the nature of the CPP Hoist being installed closely to the ceiling, very little lint would be likely to gain access into the hoist’s workings. The hoist is recommended as per Service Guide to be wiped cleaned during every hoist inspection.
- Dust – Due to the nature of the CPP Hoist being installed closely to the ceiling, very little dust would be likely to gain access into the hoist’s workings.
- Light – The User controls have been designed to be easily recognisable and the use of bright colours will help the user through all ranges of lighting. The Specification of the hoist dictates that normal use would occur during ambient luminance 50 – 500 lux. Additional as the hoist is designed for indoor use only, if required the user may wish to switch on room lighting.

## 8.1 Normal operating conditions

+5°C to +40°C (41°F to 104°F) at a relative humidity between 15% to 90% RH, non-condensing but not requiring a water vapour pressure greater than 50hPa and atmospheric pressure between 700hPa to 1060hPa

## 8.2 Shipping and storage conditions

-25°C to +5°C (-13°F to 41°F) with any humidity level.

+5°C to +35°C (41°F to 95°F) at a relative humidity up to 90%.

+35°C to 70°C (95°F to 158°F) non-condensing at a water vapour pressure up to 50hPa.

12 hours are required for the hoist to cool from the maximum storage temperature until ready for its intended use when the ambient temperature is 20°C (68°F).

12 hours are required for the hoist to warm from the minimum storage temperature until ready for its intended use when the ambient temperature is 20°C (68°F).

## 9.0 Disposal



When the Hoist has completed its life cycle and can no longer perform to its intended use safely the Hoist must be decommissioned by an approved trained professional. The following specifies the importance of correct disposal procedure including local laws and being environmentally friendly.

Please observe the local laws on recycling and respect the current laws for disposal within the community the device is being used within. If there is any uncertainty of the below guidelines, contact your local authorities to determine the proper method of disposal of potentially biohazardous parts and accessories.

The relevant components utilised in the manufacture of the device that can be recycled at the end of the device life are:

| Fully recyclables:                          | Consideration when Recycling: |
|---|-------------------------------|
| Chassis                                     | Batteries                     |
| Plastic Covers                              | Wiring Looms – electronics    |
| Metallic Internals – Hub etc.               | PCB                           |
| Initial packaging of the device (cardboard) | Hand Control                  |
| Metallic fixing – Screws etc.               | Motors                        |
| Plastic Mouldings                           | Lift Tape                     |
| Carry Bar                                   | Charger                       |
| Trolley                                     |                               |
| Reacher Pole                                |                               |

Table 10

Ensure that this list is used as guidance and that the local laws in the given community overrule the suggested component disposal in the table above.



The product may be contaminated and has to be disinfected before decommissioning. See section 'Cleaning' in the User Manual for details of how to do this.

## 10.0 Fault Finding

If a problem arises with the Hoist, the Table below will hopefully assist in determining the fault and what actions you can take. If the fault cannot be found or the fault is found and the action guide does not provide a fix (e.g. – a damaged wire would need replacement), contact your local Mackworth authorized dealer immediately, an approved professional will be required to repair the Hoist. Contact details can be found on the last page of this manual.

| Fault   | Action   |
|---|--|
| The Handset has become disengaged from the Hoist, or the Handset buttons are not responding.                    | Refer to the section 4.3 'Connecting the Handset to The Hoist'. If this does not correct the fault, then contact your local authorised dealer immediately so the hoist can be checked to ensure proper continued operation.  |
| The handset button command is continuously activated – UP, DOWN, E-LOWER.                                       | Turn off the Hoist using the OFF cord by pulling it down. Contact your local authorised dealer immediately so that the hoist can be checked to ensure proper continued operation.  |
| The carry bar of the Hoist does not move UP or DOWN even when the handset has been properly connected.          | The indicator light on the control panel should be green and show that there is power. If it is not, then pressing any coloured button on the handset to activate the hoist and the indicator light should turn GREEN.<br>If the hoist still does not function, then the batteries may be low and require charging. Refer to the section 5.5 'Charging the Hoist '. Charge the hoist for at least one hour and then try to raise/lower the carry bar.<br>If none of these resolve the fault, DO NOT use the Hoist. Contact your local authorised dealer immediately so that the hoist can be checked to ensure proper continued operation. |
| The Hoist LED's indicate there is power, but the Hoist does not operate in the DOWN direction.                  | A built-in detector checks the slackness of the lift tape. This may be sensitive. Apply weight to the carry bar while pressing the DOWN button at the same time. If this corrects the fault temporarily but not permanently then contact your local authorised dealer so that the Hoist can be checked to ensure proper continued operation  |
| The red indicator light on the hoist turns RED and/or a loud alarm sound is heard when an individual is raised. | The batteries are low and require charging. Refer to section 5.5 'Charging the Hoist' and charge the hoist for at least one hour before trying to raise/lower the carry bar.<br>If this does not correct the fault, then contact your local authorised dealer immediately so that the hoist can be checked to ensure proper continued operation.   |
| One side of the lift tape is starting to fray after continued use.  | Contact your local authorised dealer immediately so the hoist can be checked to ensure proper continued operation.   |
| The hoist does not pass through a track component such as a turntable or gate.                                  | Refer to the User Manual of the specific piece of equipment in question. If the recommended solution does not correct the fault, then contact your local authorised dealer immediately so that the track component and hoist can be checked to ensure proper continued operation.  |

Table 11



## 10.1 LED Display

Should a problem arise with the use of the Hoist review the table below gives an indication as to the status of the device through reference to the LED's shown on the hoist unit.

Find the fault and complete the recommended solution.

If the fault is not found and/or the solution does not correct the problem, contact your local Mackworth authorized dealer immediately – contact details are provided on the last page of this manual.

| LED 1 | LED 2 | LED 3 | LED 4 | Buzzer                             | Function                             | Action                    |
|-------|-------|-------|-------|------------------------------------|--------------------------------------|---------------------------|
|       |       |       |       | No                                 | 75% - 100% Battery Capacity          | None                      |
|       |       |       |       | No                                 | 50% - 75% Battery Capacity           | None                      |
|       |       |       |       | No                                 | 25% - 50% Battery Capacity           | None                      |
|       |       |       |       | No                                 | 10% - 25% Battery Capacity           | None                      |
|       |       |       |       | 2 Beeps (1 sec apart) x 3 cycles   | 0% - 10% Battery Capacity            | Charge Hoist              |
|       |       |       |       | No                                 | Hoist Charging                       | None                      |
|       |       |       |       | No                                 | Hoist charged (connected to charger) | None                      |
|       |       |       |       | 2 Beeps (0.5 sec apart)            | Upper limit reached                  | Release Up button         |
|       |       |       |       | 2 Beeps (1 sec apart)              | Lower limit reached                  | Release Down button       |
|       |       |       |       | Solid Beep                         | Emergency lower Activated            | General Information       |
|       |       |       |       | No                                 | Hoist Standby/Switched Off           | General Information       |
|       |       |       |       | 1 Beep (1 sec apart) x 2 cycles    | Maximum patient load exceeded        | Review loading            |
|       |       |       |       | No                                 | Motor -Max temperature exceeded      | Allow Hoist to cool       |
|       |       |       |       | No                                 | Battery - Max temperature exceeded   | Allow Hoist to cool       |
|       |       |       |       | 3 Beeps (0.5 sec apart) x 2 cycles | Motor current delta limit exceeded   | Call Engineer Promptly    |
|       |       |       |       | 4 Beeps (0.5 sec apart) x 2 cycles | Battery voltage delta exceeded       | Call Engineer Promptly    |
|       |       |       |       | 5 Beeps (0.5 sec apart) x 2 cycles | Battery temperature sensor fault     | Call Engineer Immediately |
|       |       |       |       | 6 Beeps (0.5 sec apart) x 2 cycles | Charging system fault                | Call Engineer Immediately |
|       |       |       |       | 7 Beeps (0.5 sec apart) x 2 cycles | Motor temperature sensor fault       | Call Engineer Immediately |
|       |       |       |       | 8 Beeps (0.5 sec apart) x 2 cycles | Limit switch fault                   | Call Engineer Immediately |

Table 12



LED'S are solid

LED's are flashing.

## 11.0 General Inspection, Maintenance and Cleaning

### 11.1 Service



No service is to be carried out on the Hoist while transferring a person to reduce the risk of injury. Service must be completed by a Mackworth approved trained professional. Do not attempt to service the product yourself, or warranty is void.

To ensure the safety and continued good function of your Hoist, routine service must be performed on your Mackworth CPP Hoist.

Service should be completed by a Mackworth approved trained professional every 6 months to ensure the products required standard is maintained. The service history of the product should be documented each service in the Service Log at the back of this User Manual.



When the Hoist is serviced, the 6 month service checklist must be completed for the Mackworth CPP Hoist.

Service Manual Document Number: 995086.

Spare Parts Manual Document Number: 992086.

The Service must be completed every 6 months after installation of the Hoist to comply with LOLER Regulations.

The Mackworth CPP Hoist has an expected Service Life of 10 Years.

Contact your local authorised Mackworth dealer if you:

- Need more information.
- Have any questions about the use or service of your Hoist.
- Notice any change in the performance.
- Want to report an unexpected occurrence.
- Want to arrange a service.
- Need to ascertain necessary information for replacement parts and components.

Contact details of your local Mackworth dealer are shown on the last page of this manual.

### 11.2 Inspection

**Inspection is to be completed prior to each use by the user of the Hoist.**



Should any of the components in the table below fail the inspection, DO NOT use the Hoist. Contact your local authorized dealer for service – contact details are on the last page of this manual.

Ensure all component inspections in the Table below are completed prior to each use of the Hoist.

#### Check List before Use

| Component           | Service/Inspection required  |
|---------------------|--|
| Generic             | Visual inspection of the external of the Hoist. Significant damage that may affect the function of the Hoist along with a clear safety hazard is unacceptable.   |
|                     | Check the Labelling on the Hoist to ensure they are all still legible, this includes the Serial Number and other important markings. If labels are not legible, then contact your local authorised dealer immediately. |
|                     | Check all nuts and bolts that are accessible and visible to see if they are loose, (such as the Carry Bar Hook). If they are not tight or you have concerns, then contact your local authorised dealer immediately.    |
| Emergency Stop Cord | Check the emergency stop cord functionality.   |
| Carry Bar           | Inspect the sling looped attachments for any damage, sharp edges and excessive wear.   |
|                     | Check the carry bar rotates and swings freely, and that there is no build-up of wear.  |
|                     | Ensure the Spring Clips on the Carry Bar are functional and present.   |

|                                 |   |
|---------------------------------|---|
| <b>Lift Tape</b>                | Inspect the Hoist Lift Tape for any signs of damage such as fraying, breaking and tearing along its entire length. Ensure to also inspect the stitching on the tape for the same signs of damage. |
| <b>QRS (Quick Release Hook)</b> | Ensure that the locking device on the QRS is closed when the carry bar is attached.<br>Inspect the QRS for damage such as cracking. And ensure that the locking device is functioning correctly.  |
| <b>LED's</b>                    | Ensure that the LED's are all working correctly prior to use.   |
| <b>Wheels</b>                   | Ensure the wheels are traversing smoothly in the track before traversing a patient along the system. Listen for any unusual noises.   |
| <b>Motor</b>                    | When raising and lowering the Hoist, with or without load, listen to the motor for any unusual lifting noises. Lower the patient immediately if an unusual noise is present.                      |
| <b>Handset</b>                  | Ensure the Handset is functional, ensure the connection to the Hoist is correct and that all the buttons are working before operation with a patient.   |
| <b>Trolley</b>                  | Ensure that the CPP is attached to the Trolley correctly, with the QRS locking mechanism closed.<br>Ensure that the Trolley is able to swivel smoothly without restraint.                         |

Table 13

### 11.2.1 Lift Tape Caution

The image (Figure 45) indicates a badly worn lift tape due to an accumulation of events the Hoist has operated under.



Whilst a tape in this condition provides no immediate danger, the Hoist should not be used until a service agent can replace the damaged tape.

The visual checks that must be performed before each use will make the operator aware of a tape degrading. Any damage should prompt the operator to cease use and seek a replacement.



Figure 45

## 11.3 Cleaning

Please follow the cleaning guidelines below on cleaning and disinfecting the Hoist.

### 11.3.1 General Cleaning



It is recommended to clean the Hoist and accessories before use by a different person, reducing the risk of cross-contamination.

The exterior of the Hoist can be cleaned using a damp soapy cloth for general cleaning duties. Please ensure the cloth is damp and not wet. Ensure the exterior of the device is dry after cleaning. Dry using a clean dry cloth.

**For the Handset and Lift Tape, use a dry cloth wipe only.**



Care should always be taken when cleaning around electrical components to reduce the risk of electric shock or damage to the hoist.

### 11.3.2 Disinfecting (if necessary)

Should the Hoist require a more thorough clean, the use of the Actichlor™ disinfectant product (which is widely available in tablet form and used throughout the health care industry) is recommended.



Follow the manufacturer’s safety instructions for the use of the cleaning product before use to ensure safe use for the operator and the patient.

Ensure the cloth is damp before the cleaning process.

Application is through a clean damp cloth applied to wipe the device down. Use in the following dilutions to ensure an effective clean:

- Actichlor™ dissolvable chlorine tablets provide a concentration of 1000 ppm of available chlorine (0.1%) per 1 tablet
- 1 tablet (1.7g formed tablet (x1)) will create a virucidal solution, diluted in 1 litre of water to provide effective means to clean a “dirty” device. This is also ideal for use after an outbreak of the Norovirus/winter vomiting and can be used as a precaution against C.Diff. It is effective against viruses, bacteria, spores, yeasts and moulds.
- The contact time against the outer components of the device should be for 5 minutes to prevent any virucidal infections without a degradation to the functionality of the device. 5 minutes is a recommended contact time. The device can withstand a longer contact period but the 5 minute recommendation as a minimum must be followed to provide an effective cleaning regime.
- Blood spills should be dealt with by an increased concentration of the solution – please refer to the instructions on the manufacturers product labelling.

#### Dilution chart

| Product used as           | Device condition | Concentration (ppm) | Dilution qty* (l) | Tablets per 1l (0.26gal) | Contact time (minutes) |
|---------------------------|------------------|---------------------|-------------------|--------------------------|------------------------|
| <b>Bactericidal</b>       | Clean            | 200                 | 5 (1.32gal)       | 1                        | 1                      |
|                           | Dirty            | 1000                | 1 (0.26gal)       | 1                        | 5                      |
| <b>Yeasticidal</b>        | Clean            | 200                 | 5 (1.32gal)       | 1                        | 1                      |
|                           | Dirty            | 1000                | 1 (0.26gal)       | 1                        | 5                      |
| <b>Fungicidal</b>         | Clean            | 2000                | 1 (0.26gal)       | 2                        | 15                     |
|                           | Dirty            | 5000                | 1 (0.26gal)       | 5                        | 15                     |
| <b>Mycrobactericidal</b>  | Clean            | 1000                | 1 (0.26gal)       | 1                        | 15                     |
|                           | Dirty            | 5000                | 1 (0.26gal)       | 5                        | 15                     |
| <b>Virucidal</b>          | Clean            | 500                 | 2 (0.53gal)       | 1                        | 5                      |
|                           | Dirty            | 1000                | 1 (0.26gal)       | 1                        | 5                      |
| <b>Sporcidal (C.Diff)</b> | Clean            | 1000                | 1 (0.26gal)       | 1                        | 10                     |
|                           | -                | -                   | -                 | -                        | -                      |
| <b>Sporcidal</b>          | Clean            | 5000                | 1 (0.26gal)       | 5                        | 10                     |
|                           | -                | -                   | -                 | -                        | -                      |

\* Dilution is made with water. DO NOT dilute within any other medium.

- When diluted in water, one tablet gives 1000ppm of available chlorine.
- The concentration of the solution depends upon whether the object being cleaned is noticeably dirty (indicated in the table by “Device condition”).

Table 14

## Handling and storage safety precautions when using this cleaning agent:

### Advice on Safe Handling



- Avoid contact with skin and eyes.
- Do not breathe dust/fumes/gas/mist/vapours/spray.
- Use only with adequate ventilation.
- Wash hands thoroughly after handling.
- Mixing this product with acid or ammonia releases chlorine gas.

### Hygiene Measures

Handle in accordance with good industrial hygiene and safety practice. Remove and wash contaminated clothing before re-use. Wash face, hands and any exposed skin thoroughly after handling.

### Conditions for safe storage, including and incompatibilities



- Keep out of reach of children.
- Keep container tightly closed.
- Store in suitable labelled containers.
- Storage temperature: 0-25°C (32-77°F).

### Individual protective measures

Hand protection: Gloves

### Dissolve

Dissolve in cold water – With no agitation, 1 tablet will take approximately 10 minutes to fully dissolve in the water used.

The information above has been extracted from the Actichlor™ MSDS (Manufacturers Safety Data Sheet). For a full review of the data please follow the link below:

## 12.0 Warranty

This guarantee does not affect or in any way limit your Statutory Rights.

1. Mackworth guarantees the CPP, supplied as new, against failure within the period of 12 months from the date of purchase by virtue of defects in material or workmanship.
2. The liability of Mackworth under terms of this guarantee shall be limited to the replacement or the defective part(s) to the sales distributor, dealer, agent, person or entity which purchased the equipment from Mackworth. In no event shall Mackworth incur liability for any consequential or unforeseeable losses.
3. This equipment guarantee shall be void if the equipment is not serviced by Mackworth or its authorized agents, in accordance with manufacturer's recommendations, or if any unauthorized persons carry out work on the equipment.
4. This guarantee does not apply to failure attributable to normal wear and tear, damage by natural forces, user neglect or misuse or to deliberate destruction.
5. Do not attempt to service the product yourself, or warranty is void.
6. Exemptions: Batteries will be guaranteed for a period of 90-days after original purchase.
7. Do not transfer the hoist from one track system to another using the reacher yourself, this must be done by an approved professional.