

B FRAME MEASUREMENTS 1/2

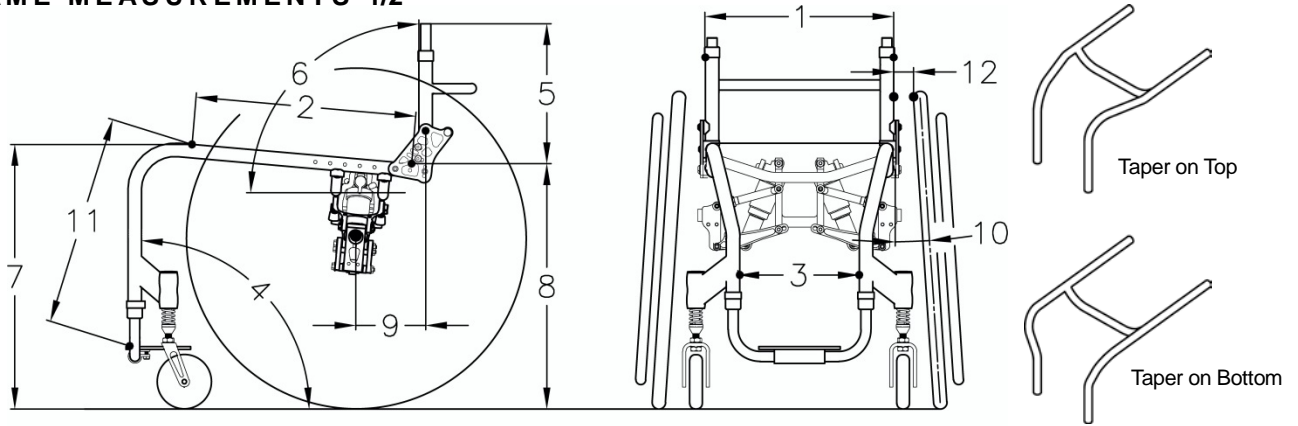

1. SEAT WIDTH	<input type="checkbox"/> 13" <input type="checkbox"/> 14" <input type="checkbox"/> 15" <input type="checkbox"/> 16" <input type="checkbox"/> 17" <input type="checkbox"/> 18" <input type="checkbox"/> 19" <input type="checkbox"/> 20" E2201								
2. SEAT DEPTH * Only Choose One Option	<input type="checkbox"/> Net Seat Depth <input type="checkbox"/> 13" <input type="checkbox"/> 14" <input type="checkbox"/> 15" <input type="checkbox"/> 16" <input type="checkbox"/> 17" <input type="checkbox"/> 18" <input type="checkbox"/> 19" E2203 <input type="checkbox"/> Depth Adj. Frame <input type="checkbox"/> Short Frame (16" Depth) Set at <input type="checkbox"/> 13" <input type="checkbox"/> 14" <input type="checkbox"/> 15" <input type="checkbox"/> 16" .. <input type="checkbox"/> Long Frame (19" Depth) Set at <input type="checkbox"/> 16" <input type="checkbox"/> 17" <input type="checkbox"/> 18" <input type="checkbox"/> 19" ..								
	<input type="checkbox"/> Aluminum Seat Base (250-300lbs) E2231 <input type="checkbox"/> Positioning Frame Add (") <input type="checkbox"/> Ergo Seat Tubing Depth (") *Measurement must be 2.5" longer than your Center of Gravity <div style="text-align: right;"> </div>								
3. FOOTREST WIDTH	<input type="checkbox"/> STD (Seat Width Minus 5") <input type="checkbox"/> Taper on Top <input type="checkbox"/> Taper on Bottom <input type="checkbox"/> Custom (") <input type="checkbox"/> Taper on Top <input type="checkbox"/> Taper on Bottom <input type="checkbox"/> No Taper (Seat Width Minus 2")-.								
FOOT PLATE STYLE	<input type="checkbox"/> Standard single loop with adjust. height & angle. STD Foot Plate <input type="checkbox"/> Single Flip-Back-single loop (no riser avail) with adjust. height & angle. STD Foot Plate K0040, K0045 <input type="checkbox"/> No Foot Plate with extra stabilizer bar for foot propel (amputee) STD Foot Plate Size Chart <table border="1" style="display: inline-table; margin-left: 20px;"> <thead> <tr> <th>Your Footrest Width</th> <th>Foot Plate Size</th> </tr> </thead> <tbody> <tr> <td>8.5"-10.0"</td> <td>W6.5"xD5"</td> </tr> <tr> <td>10.5"-13.0"</td> <td>W8.5"xD6.5"</td> </tr> <tr> <td>13.5"-17.0"</td> <td>W11"xD6.5"</td> </tr> </tbody> </table> <div style="text-align: right;"> </div>	Your Footrest Width	Foot Plate Size	8.5"-10.0"	W6.5"xD5"	10.5"-13.0"	W8.5"xD6.5"	13.5"-17.0"	W11"xD6.5"
Your Footrest Width	Foot Plate Size								
8.5"-10.0"	W6.5"xD5"								
10.5"-13.0"	W8.5"xD6.5"								
13.5"-17.0"	W11"xD6.5"								
CUSTOM FOOT PLATE <input type="checkbox"/> Foot Propel w/ Stabilizer Bar Style	<input type="checkbox"/> Custom Foot Plate with adjust. height & angle *Available Solid Plate Only <div style="text-align: right;"> </div>								
<input type="checkbox"/> Add Anti-Skid Tape	<input type="checkbox"/> Custom Tubular Footrest <div style="text-align: right;"> </div> <input type="checkbox"/> With ABS Foot Plate (\$75 up charge)								
4. FRAME ANGLE	<input type="checkbox"/> 75° <input type="checkbox"/> 80° <input type="checkbox"/> 85° <input type="checkbox"/> 90° to the ground <input type="checkbox"/> Custom (°) to the ground *Up to 65°								

B FRAME MEASUREMENTS 2/2

5. BACKREST HEIGHT	<input type="checkbox"/> 8" <input type="checkbox"/> 9" <input type="checkbox"/> 10" <input type="checkbox"/> 11" <input type="checkbox"/> 12" <input type="checkbox"/> 13" <input type="checkbox"/> 14" <input type="checkbox"/> 15" <input type="checkbox"/> 16" <input type="checkbox"/> 17" <input type="checkbox"/> 18"	<small>Adj. Range</small> <small>Adj. Range</small> <small>Adj. Range</small>															
* Rigidizer bar 3.25" deep std.																	
TYPE	<input type="checkbox"/> Locking mechanism with adjust. height & angle																
	<input type="checkbox"/> Double Locking mechanism with adjust. height & angle																
	<input type="checkbox"/> Folding with adjust. height & angle																
CUSTOM	<input type="checkbox"/> Welded Backrest Angle Set at (") to the ground *Non Folding Backrest . . . only.																
	<input type="checkbox"/> Welded Side Guards *Non Folding Backrest only.																
		<input type="checkbox"/> Custom Backrest (ie: double rigidizer bars, custom depth, custom height, etc)															
6. BACKREST ANGLE	Set at (°) to the ground *STD 90°																
7. FRONT SEAT HEIGHT	<input type="checkbox"/> 16.0" <input type="checkbox"/> 16.5" <input type="checkbox"/> 17.0" <input type="checkbox"/> 17.5" <input type="checkbox"/> 18.0" <input type="checkbox"/> 18.5" <input type="checkbox"/> 19.0" <input type="checkbox"/> 19.5" <input type="checkbox"/> 20.0" <input type="checkbox"/> 20.5" <input type="checkbox"/> 21.0"																
Front Seat Height Ranges		<table border="1" style="width:100%; border-collapse: collapse;"> <thead> <tr> <th>Caster Wheel Size</th> <th>Front Seat Height</th> </tr> </thead> <tbody> <tr> <td>3" Caster</td> <td>16.0" - 19.5"</td> </tr> <tr> <td>4" Caster</td> <td>16.0" - 20.0"</td> </tr> <tr> <td>5" Caster</td> <td>16.0" - 21.0"</td> </tr> </tbody> </table>	Caster Wheel Size	Front Seat Height	3" Caster	16.0" - 19.5"	4" Caster	16.0" - 20.0"	5" Caster	16.0" - 21.0"							
Caster Wheel Size	Front Seat Height																
3" Caster	16.0" - 19.5"																
4" Caster	16.0" - 20.0"																
5" Caster	16.0" - 21.0"																
8. REAR SEAT HEIGHT	<input type="checkbox"/> 16.0" <input type="checkbox"/> 16.5" <input type="checkbox"/> 17.0" <input type="checkbox"/> 17.5" <input type="checkbox"/> 18.0" <input type="checkbox"/> 18.5" <input type="checkbox"/> 19.0" 																
Rear Seat Height Ranges		<table border="1" style="width:100%; border-collapse: collapse;"> <thead> <tr> <th>Rear Tire Size</th> <th>Rear Seat Height</th> </tr> </thead> <tbody> <tr> <td>24"x1"(540)</td> <td>16.0" - 18.5"</td> </tr> <tr> <td>24"x1 3/8"(540)</td> <td>16.5" - 19.0"</td> </tr> <tr> <td>25"x1"(559)</td> <td>16.5" - 19.0"</td> </tr> <tr> <td>24"x2"(540)</td> <td>17.0" - 19.0"</td> </tr> <tr> <td>26"x1"(590)</td> <td>17.0" - 19.0"</td> </tr> <tr> <td>25"x1.95"(559)</td> <td>17.0" - 19.0"</td> </tr> </tbody> </table>	Rear Tire Size	Rear Seat Height	24"x1"(540)	16.0" - 18.5"	24"x1 3/8"(540)	16.5" - 19.0"	25"x1"(559)	16.5" - 19.0"	24"x2"(540)	17.0" - 19.0"	26"x1"(590)	17.0" - 19.0"	25"x1.95"(559)	17.0" - 19.0"	
Rear Tire Size	Rear Seat Height																
24"x1"(540)	16.0" - 18.5"																
24"x1 3/8"(540)	16.5" - 19.0"																
25"x1"(559)	16.5" - 19.0"																
24"x2"(540)	17.0" - 19.0"																
26"x1"(590)	17.0" - 19.0"																
25"x1.95"(559)	17.0" - 19.0"																
*No Custom Modifications																	
9. CENTER OF GRAVITY	<input checked="" type="checkbox"/> 1.5" <input checked="" type="checkbox"/> 2.0" <input type="checkbox"/> 2.5" <input type="checkbox"/> 3.0" <input type="checkbox"/> 3.5" <input type="checkbox"/> 4.0" <input type="checkbox"/> 4.5" <input type="checkbox"/> 5.0" *Not Available w / Net Seat Depth Frame																
10. CAMBER ANGLE	<input type="checkbox"/> 2° <input type="checkbox"/> 4° 																
11. FRONT OF SEAT SLING TO FRONT OF FOOTREST	<input checked="" type="checkbox"/> 15.0" <input checked="" type="checkbox"/> 15.5" <input checked="" type="checkbox"/> 16.0" <input type="checkbox"/> 16.5" <input type="checkbox"/> 17.0" <input type="checkbox"/> 17.5" <input type="checkbox"/> 18.0" <input type="checkbox"/> 18.5" <input type="checkbox"/> 19.0" <input type="checkbox"/> 19.5"																
*Not Available w / 19.0" , 19.5" , 20.0" , 20.5" , 21.0" Front Seat Height																	
*Measurement must be 1.5" shorter than your Front Seat Height																	
HIGH MOUNT With Risers or Clamps	<input type="checkbox"/> 11.0" <input type="checkbox"/> 11.5" <input type="checkbox"/> 12.0" <input type="checkbox"/> 12.5" <input type="checkbox"/> 13.0" <input type="checkbox"/> 13.5" <input type="checkbox"/> 14.0" <input type="checkbox"/> 14.5" <input type="checkbox"/> 15.0" <input type="checkbox"/> 15.5" <input type="checkbox"/> 16.0" K0040																
12. INSIDE WHEEL CLEARANCE	<input type="checkbox"/> 3/4"* <input type="checkbox"/> 1" <input type="checkbox"/> 1 1/4" <input type="checkbox"/> 1 1/2" <input type="checkbox"/> 1 3/4" <input type="checkbox"/> 2" <small>*3/4" Inside wheel clearance not available with 2 degree camber. (with the exception of Y-360 wheels)</small> <small>*3/4" Inside wheel clearance not available with Armrest</small>																
REAR SUSPENSION RATING	<input type="checkbox"/> Set up 50psi (For 80 lbs-110 lbs weight) <input type="checkbox"/> Set up 100psi (For 170 lbs-200 lbs weight) <input type="checkbox"/> Set up 60psi (For 110 lbs-140 lbs weight) <input type="checkbox"/> Set up 120psi (For 200 lbs-230 lbs weight) <input type="checkbox"/> Set up 80psi (For 140 lbs-170 lbs weight) <input type="checkbox"/> Set up 150psi (For 230 lbs-250 lbs weight)																
SHOCK OPTION	<input checked="" type="checkbox"/> Fox Racing Shox 300 HP Pump *Customer Needs Pump To Adjust Rear Suspension Rating <input type="checkbox"/> Omit Air Pro System																
Pick Color AirTubes:	<input type="checkbox"/> Black <input type="checkbox"/> Yellow <input type="checkbox"/> Orange <input type="checkbox"/> Blue <input type="checkbox"/> Red																

1. SEAT WIDTH

Measure from outside of seat tube to the outside of the opposite seat tube.

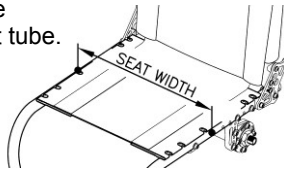

2. SEAT DEPTH

Measure from at the front bottom of backrest tube to the front edge of seat sling.

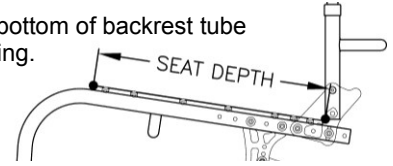

3. FOOTREST WIDTH

Measure from inside of front frame tube to inside of opposite front frame tube.

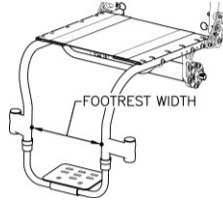

4. FRAME ANGLE

Measure angle frame front to floor.

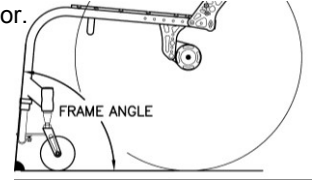

5. BACKREST HEIGHT

Measure from top of back post to seat sling at front bottom of backrest tube.

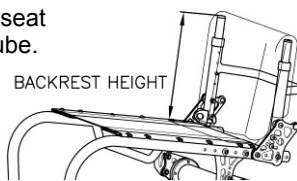

6. BACKREST ANGLE

Measure angle from front of back post to floor.

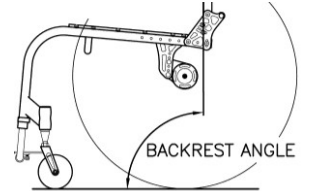

7. FRONT SEAT HEIGHT

Measure from floor to top of seat sling at front edge.

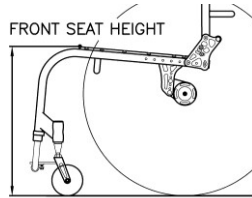

8. REAR SEAT HEIGHT

Measure from floor to top of seat sling at front bottom of backrest tube.

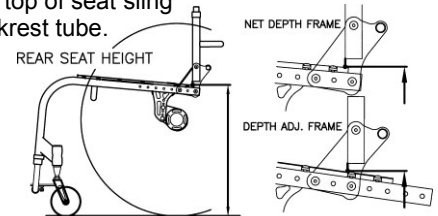

9. CENTER OF GRAVITY

Measure from center of back tube at the folding pivot to the center of the rear axle.

(If welding backrest is selected, Measure from center of back tube at the seat tube to the center of the rear axle.)

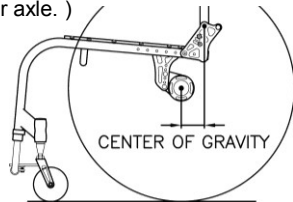

10. CAMBER ANGLE

Measure angle from wheel to vertical at floor.

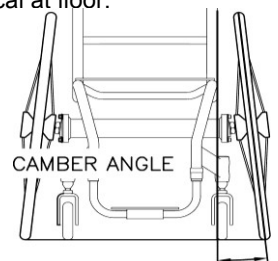

11. FRONT OF SEAT SLING TO FOOTREST

ADULT CHAIR

Measure from top of seat sling at front edge to top of foot plate at front edge.

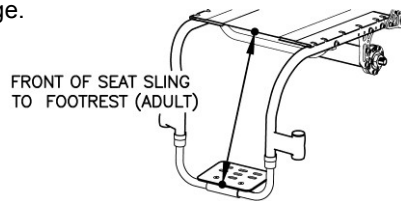

PEDIATRIC CHAIR

Measure vertical from top of seat sling at front edge to top of foot plate.



12. INSIDE WHEEL CLEARANCE

Measure from outside of seat back tube to inside of rear tire.

(If side guards are selected, measure from outside of side guards to inside of rear tire.)

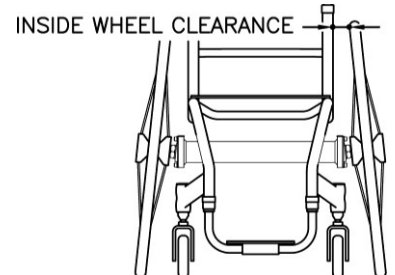

C SPECIAL PARTS COLORS (Please allow an additional 1-2 weeks delivery)

PARTS COLORS						
Powder-Coated	Gloss Black	Twilight Flake	Yellow	Magenta	Fire Engine Red	White
Neon Red	Candy Blue	Candy Purple	Candy Green	Candy Red	Candy Raspberry	Cobalt Blue
Brass Metal	Matte Gray	Matte Purple	Matte Blue	Matte Green	Matte Black	Matte Red
Sparkle Burgundy	Reed Green	Neon Green	Orange Sparkle	Mellon Yellow	Gun Smoke Silver	Blue Lilac
Shocker Yellow	Neon Yellow	Granny Sparkle Green	Sparkle Sky Blue			

Special Colors	Polished Aluminum	
	24 karat Gold Plated	*Please allow an additional 4 weeks delivery

Please Choose the Color for each Part

*Parts not selected will be black color. (Suspension Spring: Silver Color)
 *Minimum 3 parts selected per order.

*PC=Powder-Coated

Saddle Stops
 PC () _____
 Polished..... _____
 Gold Plated..... _____

Backrest Frame
 PC () _____
 Polished..... _____
 Gold Plated..... _____

Backrest Brackets
 PC () _____
 Polished..... _____
 Gold Plated..... _____

Foot Plate
 PC () _____
 Polished..... _____
 Gold Plated..... _____

Footrest Rings
 PC () _____
 Polished..... _____
 Gold Plated..... _____

Foot Plate Clamps
 PC () _____
 Polished..... _____
 Gold Plated..... _____

Footrest Tubes
 PC..... _____
 Polished..... _____
 Gold Plated..... _____

Caps
 PC () _____
 Polished..... _____
 Gold Plated..... _____

Front Springs
 PC () _____
 Polished..... _____
 Gold Plated..... _____

Forks & Knurl Nuts
 PC () _____
 Polished..... _____
 Gold Plated..... _____

Suspension Main Frame
 PC () _____
 Polished..... _____
 Gold Plated..... _____

Upper A-Arms
 PC () _____
 Polished..... _____
 Gold Plated..... _____

Lower A-Arms
 PC () _____
 Polished..... _____
 Gold Plated..... _____

Axle Receiver Holder
 PC () _____
 Polished..... _____
 Gold Plated..... _____

D COMPONENTS

WHEEL LOCKS

New Solutions Push to Lock w/ 2" Extension Handle (\$80 up charge)

Gallop Push to Lock / Anodized

Question Mark Style Scissor

NEW Compact Scissor Lock / Anodized Black Only

Gallop Scissor Lock / Anodized

PUSH HANDLES *If you are ordering push handles, You must select the backrest locking mechanism.

Integrated w/Fixed Backrest Height / Anodized Black Only

Bolt-on / Anodized Black Only Specify Height from floor -()

Bolt-on w/Quick Release / Anodized Black Only Specify Height from floor -()

NEW Height Adj. / Anodized Black Only Specify Maximum height from floor -()

NEW ARM RESTS Anodized Black Only

Fixed Tubular Armrest Adj. Angle and Height Height from seat sling Set at : 8" 9" 10" 11" 12" **E0973**

Swing Away Tubular Armrest Adj. Angle and Height Height from seat sling Set at : 8" 9" 10" 11" 12" **E0973**

Flip-Up Armrest w/Fixed Tubular Armrest Height from seat sling Set at : 8" 9" 10" 11" 12" **E0973**
Adj. Angle w/ Swing Away Tubular Armrest Height from seat sling Set at : 8" 9" 10" 11" 12" **E0973**

Custom Length & Height (\$150 up charge)
*Specify Height & Length →

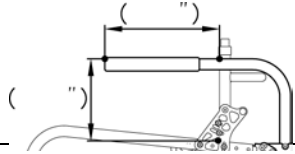

ANTI-TIPPERS

Removable Anti-tipper(pair) Anodized Black Only **E0971**

Press Release Removable Anti-tipper(pair) **E0971**

SIDE GUARDS

Rigid Side Guards - Black ABS Non-Removable Removable Removable w/Hole (\$12 up charge)
Color: Black Only | Size: STD Medium Cut to Wheel (\$98 up charge) Measurement

Rigid Side Guards - Aluminum Non-Removable Removable
Size: Medium Only Cut to Wheel (\$98 up charge) Measurement
Color Black (STD) Pol. Aluminum (STD)
 Powder Coated () (\$120 up charge)
 Gold Plate (+CFP)

Height	Size
7.5"	STD
8.25"	Medium

Fabric Clothing Guards Black Nylon w/Velcro

SEAT CUSHION -*Please see section for other cushion choices.-

Foam Cushion w/Nylon Black Cover Thickness 1" 2" 3" 4"

Custom Cushion Cover (Std. Foam Cushion Only) -Select Fabric () (\$90 up charge)

ACCESSORIES

Frame Protectors / Black Leather/Zipper Type

Gel Ovation Protector Wraps Gel Silicone

E0978 Seat Belt w/Auto Buckle (BP) 1.5" Black Belt Only **E0978**

Tie Down Brackets 4pcs.

Calf Strap Black Matching Fabric (\$55 up charge) -Select Fabric ()

Bodypoint Padded Calf Strap (14"-16" footrest width) (16"-20" footrest width) (20"-24" footrest width)
\$77 \$83 \$89

Hanging Zipper Pouch Black Matching Fabric (\$60) or Leather (\$75) Custom Size Width: Length:

Matching Fabric on Padded Side Guards -Select Fabric ()

UPHOLSTERY CHOICE & COLOR *Positioning Back Available. Please see Section E

Standard Adjustable Height Backrest (Black)

Adjustable Tension Backrest Black Only (*Not available with 8" Backrest Height)

Options Fun Fabric: For Std. or Adj. Style
(Choose From Choices on Page 7 and write below) (\$ 80 up charge)

Backrest Leather Trim (outside panels) (\$ up charge)

FABRIC CHOICE SHEET

1. Camouflage Girls

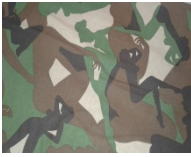

2. Purple Zebra



3. Silver Grey Snake



5. Laughing Skulls



6. Purple Snake



7. Sweetheart Pinup Girls



9. Blue Flames

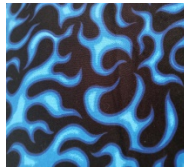

10. Arctic Camo



11. Furry Friends



12. Supercars



13. Urban Camo

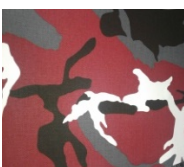

14. Superbikes



15. Sizzle Flames



16. Hot Rod Flames



17. Skulls w/ Attitude



18. Sweet Pink

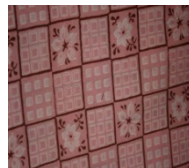

19. Heart and Soul



20. Home Run



21. Fuzzy Giraffe

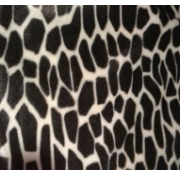

22. Cheetah



23. Paperweight Cobalt



24. Zig Zag Dots



25. Smokey Tribal Flames

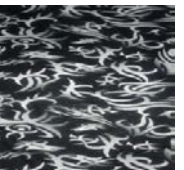

26. Rose and Rebellion



27. Tattoo Adventure(Cream

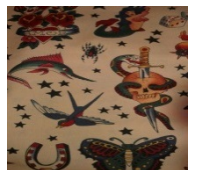

28. Red Tribal Flames

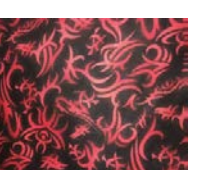

29. Tattoo Adventure(Black)

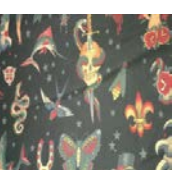

30. Butterfly Bandana

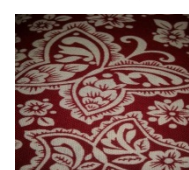

31. Tatsu Dragon

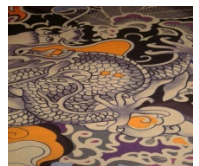

E TIRES, CASTERS, & FORKS



TIRES	
<input type="checkbox"/> Primo High Pressure Tire <input type="checkbox"/> 24"x1" <input type="checkbox"/> 25"x1" <input type="checkbox"/> 26"x1" Gray Tire w/ black line	E2211/E2212
<input type="checkbox"/> Primo High Pressure Tire <input type="checkbox"/> 24"x1" <input type="checkbox"/> 25"x1" or <input type="checkbox"/> 26"x1" <input type="checkbox"/> Blue <input type="checkbox"/> Red	E2211/E2212
<input type="checkbox"/> Low Pressure Tire <input type="checkbox"/> 24"x1-3/8" or <input type="checkbox"/> 26"x1-3/8" Gray Only	E2211/E2212
<input type="checkbox"/> Schwalbe Marathon Plus High Pressure Tire <input type="checkbox"/> 24"x1", <input type="checkbox"/> 25"x1" or <input type="checkbox"/> 26"x1" Black Only	E2211/E2212
<input type="checkbox"/> Solid Tire <input type="checkbox"/> 24"x1" <input type="checkbox"/> 25"x1" Black	E2218
<input type="checkbox"/> Solid Tire <input type="checkbox"/> 26"x1" Dark Grey	
<input type="checkbox"/> Moderate V-Track Knobby Tire 24"x1-3/8" (37-540) Gray Only	E2211/E2212
<input type="checkbox"/> Aggressive Knobby Tire 24"x 2" (50-540) Gray Only <input type="checkbox"/> Blue Line <input type="checkbox"/> Red Line	E2211/E2212
<input type="checkbox"/> Aggressive Knobby Tire 26"x 2" (50-559) Gray Only <input type="checkbox"/> Blue Line <input type="checkbox"/> Red Line	E2211/E2212
<input type="checkbox"/> Aggressive Knobby Tire 24" x 1.95"(50-540) Black Only	E2211/E2212
<input type="checkbox"/> E2211 Bell Mountain Bike Tire in Flat Defense (559) 26" X 1.75 - 2.25 Black Only	E2211/E2212
<input type="checkbox"/> Flat-Free Inserts For 24"x1-3/8" Tires Only	E2211/E2213

CASTERS					
SIZE	TIRE WIDTH	HUB COLOR	TIRE COLOR	DESCRIPTION	
<input type="checkbox"/> 3"	1"	Black Hub	Black Tire Only	Polyurethane	K0077
<input type="checkbox"/> 3"	1"	Plastic Black Hub	Clear Tire Only	Lighted, Polyurethane	A9900
<input type="checkbox"/> 3"	1"	Red Hub	Red Tire Only	Polyurethane	E2222
<input type="checkbox"/> 3"	1"	Black Hub	Clear Tire Only	Polyurethane	E2222
<input type="checkbox"/> 3"	1"	Aluminum Silver Hub	Black Tire Only	Made By Frog Legs	K0071
<input type="checkbox"/> 3"	1"	Aluminum Black Hub	Black Tire Only	Made By Frog Legs	E2222
<input type="checkbox"/> 3"	1.5"	Aluminum Silver Hub	Black Tire Only	Soft Roll Made By Frog Legs	E2222
<input type="checkbox"/> 3"	1.5"	Aluminum Black Hub	Black Tire Only	Soft Roll Made By Frog Legs	E2222
<input type="checkbox"/> 4"	1 1/8"	Plastic Black Hub	Black Tire Only	Polyurethane Not Available with Narrow Frog Leg Forks	E2222
<input type="checkbox"/> 4"	1"	Plastic Black Hub	Clear Only	Lighted, Polyurethane	E2221
<input type="checkbox"/> 4"	1"	Aluminum Silver Hub	Black Tire Only	Made By Frog Legs	E2214
<input type="checkbox"/> 4"	1"	Aluminum Black Hub	Black Tire Only	Made By Frog Legs	E2214
<input type="checkbox"/> 4"	1.5"	Aluminum Silver Hub	Tire <input type="checkbox"/> Black <input type="checkbox"/> Blue <input type="checkbox"/> Red	Soft Roll Made By Frog Legs	E1015
<input type="checkbox"/> 4"	1.5"	Aluminum Black Hub	Black Tire Only	Soft Roll Made By Frog Legs	E2214
<input type="checkbox"/> 5"	1"	Composite Black	Black Tire Only	Polyurethane	E2222
<input type="checkbox"/> 5"	1"	Plastic Black Hub	Clear Tire Only	Lighted, Polyurethane	A9900
<input type="checkbox"/> 5"	1"	Aluminum Silver Hub	Black Tire Only	Made By Frog Legs	A9900
<input type="checkbox"/> 5"	1"	Aluminum Black Hub	Black Tire Only	Made By Frog Legs	E2214
<input type="checkbox"/> 5"	1.5"	Aluminum Silver Hub	Tire <input type="checkbox"/> Black <input type="checkbox"/> Blue <input type="checkbox"/> Red	Soft Roll Made By Frog Legs	K0072
<input type="checkbox"/> 5"	1.5"	Aluminum Black Hub	Black Tire Only	Soft Roll Made By Frog Legs	E2222
<input type="checkbox"/> 6"	1.5"	Aluminum Black Hub	Black Tire Only	Soft Roll Made By Frog Legs	E2222
<input type="checkbox"/> 6"	1.5"	Aluminum Silver Hub	Black Tire Only	Soft Roll Made By Frog Legs	E2222
<input type="checkbox"/> "	<input type="checkbox"/> 1"OR <input type="checkbox"/> 1.5"	Hub Color:	Tread Color:	Soft Roll Made By Frog Legs	E2222

FORKS		<input type="checkbox"/> Frog Leg Shields(4 pcs) Only for Frog Leg Forks
<input type="checkbox"/> STD Aluminum Forks with Suspension Springs Black Only		
Extra Options for Aluminum Forks		<input type="checkbox"/> without Suspension Springs E1015
		<input type="checkbox"/> With Quick Release Axles K0073
<input type="checkbox"/> Frog Leg Suspension Forks 1" Wide (For 3", 4" x 1" width Caster and 5" STD Caster, 5" lighted Caster) Not available with Quick Release Axle		
*User's Weight _____	Color <input type="checkbox"/> Anodized Black <input type="checkbox"/> Anodized Silver	E1015
<input type="checkbox"/> Frog Leg Suspension Forks 1.5" Wide (For 3", 4" x 1.5" width Caster and 5" x 1"& 5" x 1.5" Casters) Not available with Quick Release Axle		
*User's Weight _____	Color <input type="checkbox"/> Anodized Black <input type="checkbox"/> Anodized Silver	E1015

Valid from 2022 Prices & Specifications Are Subject To Change Without Notice.

F WHEELS

WHEELS													
Wire Wheels	<input type="checkbox"/> 24" (540) <input type="checkbox"/> 25" (599) <input type="checkbox"/> 26" (590)												
Y-360 Billet Wheels <small>*Max. Capacity 220Lbs *Camber 0-2" max *Not for Sports or Rugged use</small>	<input type="checkbox"/> 25" (559) Style <input type="checkbox"/> Saw Blade												
Y-360 Billet Wheels MOD Style <small>*Max. Capacity 220Lbs *Camber 0-2" max *Not for Sports or Rugged use</small>	<input type="checkbox"/> 25" (559) Only Style <input type="checkbox"/> Tribal Sun <input type="checkbox"/> Girls <input type="checkbox"/> Eagle <input type="checkbox"/> Holy Cross <input type="checkbox"/> Hono(Flames) Specify Powder Coat Color for Insert Only () *Choose from Frame Colors												
Extra Options for <input type="checkbox"/> Powder-Coated Spokes Only () *Choose from Frame Colors (\$250 up charge)													
Spinergy Spox 18 Spokes 	<input type="checkbox"/> 24" (540) <input type="checkbox"/> 25" (559) <input type="checkbox"/> 26" (590) Spoke Color <input type="checkbox"/> Black With Silver Hub <input type="checkbox"/> Red With Black Hub <input type="checkbox"/> Yellow With Black Hub <input type="checkbox"/> Blue With Black Hub <input type="checkbox"/> White With Black Hub <input type="checkbox"/> Custom Color Spoke Pattern <table border="1" style="display: inline-table; border-collapse: collapse;"> <tr> <td></td> <td>Left Wheel</td> <td>Right Wheel</td> </tr> <tr> <td>Spokes</td> <td>Inside</td> <td>.....</td> </tr> <tr> <td>Color</td> <td>Outside</td> <td></td> </tr> <tr> <td>Hub Color</td> <td><input type="checkbox"/> Black/<input type="checkbox"/> Silver</td> <td><input type="checkbox"/> Black/<input type="checkbox"/> Silver</td> </tr> </table>		Left Wheel	Right Wheel	Spokes	Inside	Color	Outside		Hub Color	<input type="checkbox"/> Black/ <input type="checkbox"/> Silver	<input type="checkbox"/> Black/ <input type="checkbox"/> Silver
	Left Wheel	Right Wheel											
Spokes	Inside											
Color	Outside												
Hub Color	<input type="checkbox"/> Black/ <input type="checkbox"/> Silver	<input type="checkbox"/> Black/ <input type="checkbox"/> Silver											
Spinergy LX 12 Spokes 	<input type="checkbox"/> 24" (540) <input type="checkbox"/> 25" (559) <input type="checkbox"/> 26" (590) Spoke Color <input type="checkbox"/> Black With Silver Hub <input type="checkbox"/> Red With Black Hub <input type="checkbox"/> Yellow With Black Hub <input type="checkbox"/> Blue With Black Hub <input type="checkbox"/> White With Black Hub <input type="checkbox"/> Neon Green With Black Hub <input type="checkbox"/> Pink With Black Hub <input type="checkbox"/> Orange With Black Hub <input type="checkbox"/> Purple With Black Hub <input type="checkbox"/> Custom Color Spoke Pattern <table border="1" style="display: inline-table; border-collapse: collapse;"> <tr> <td></td> <td>Left Wheel</td> <td>Right Wheel</td> </tr> <tr> <td>Spokes</td> <td>Inside</td> <td></td> </tr> <tr> <td>Color</td> <td>Outside</td> <td></td> </tr> <tr> <td>Hub Color</td> <td><input type="checkbox"/> Black/<input type="checkbox"/> Silver</td> <td><input type="checkbox"/> Black/<input type="checkbox"/> Silver</td> </tr> </table>		Left Wheel	Right Wheel	Spokes	Inside		Color	Outside		Hub Color	<input type="checkbox"/> Black/ <input type="checkbox"/> Silver	<input type="checkbox"/> Black/ <input type="checkbox"/> Silver
	Left Wheel	Right Wheel											
Spokes	Inside												
Color	Outside												
Hub Color	<input type="checkbox"/> Black/ <input type="checkbox"/> Silver	<input type="checkbox"/> Black/ <input type="checkbox"/> Silver											
Spinergy X-Laced Sport Lite Extreme "XSLX" 24 Spokes 	<input type="checkbox"/> 24" (540) <input type="checkbox"/> 25" (559) <input type="checkbox"/> 26" (590) Spoke Color <input type="checkbox"/> Black With Silver Hub <input type="checkbox"/> Red With Black Hub <input type="checkbox"/> Yellow With Black Hub <input type="checkbox"/> Blue With Black Hub <input type="checkbox"/> White With Black Hub <input type="checkbox"/> Neon Green With Black Hub <input type="checkbox"/> Pink With Black Hub <input type="checkbox"/> Orange With Black Hub <input type="checkbox"/> Purple With Black Hub <input type="checkbox"/> Custom Color Spoke Pattern <table border="1" style="display: inline-table; border-collapse: collapse;"> <tr> <td></td> <td>Left Wheel</td> <td>Right Wheel</td> </tr> <tr> <td>Spokes</td> <td>Inside</td> <td></td> </tr> <tr> <td>Color</td> <td>Outside</td> <td></td> </tr> <tr> <td>Hub Color</td> <td><input type="checkbox"/> Black/<input type="checkbox"/> Silver</td> <td><input type="checkbox"/> Black/<input type="checkbox"/> Silver</td> </tr> </table>		Left Wheel	Right Wheel	Spokes	Inside		Color	Outside		Hub Color	<input type="checkbox"/> Black/ <input type="checkbox"/> Silver	<input type="checkbox"/> Black/ <input type="checkbox"/> Silver
	Left Wheel	Right Wheel											
Spokes	Inside												
Color	Outside												
Hub Color	<input type="checkbox"/> Black/ <input type="checkbox"/> Silver	<input type="checkbox"/> Black/ <input type="checkbox"/> Silver											

Valid from 2022 Prices & Specifications Are Subject To Change Without Notice.

**Spinergy Sport Lite
Extreme "SLX"
24 Spoke**



- 24" (540) 25" (559) 26" (590)
- Spoke Color Black Red Yellow Blue
 With Silver Hub With Black Hub With Black Hub With Black Hub
 White Neon Green Pink Orange Purple
 With Black Hub With Black Hub With Black Hub With Black Hub With Black Hub

<input type="checkbox"/> Custom Color Spoke Pattern		Left Wheel	Right Wheel
Spokes	Inside		
	Outside		
Hub Color		<input type="checkbox"/> Black/ <input type="checkbox"/> Silver	<input type="checkbox"/> Black/ <input type="checkbox"/> Silver

**Spinergy Lite Extreme
"XLX" X-Laced-12 Spoke**



- 24" (540) 25" (559) 26" (590)
- Spoke Color Black Red Yellow Blue
 With Silver Hub With Black Hub With Black Hub With Black Hub
 White Neon Green Pink Orange Purple
 With Black Hub With Black Hub With Black Hub With Black Hub With Black Hub

<input type="checkbox"/> Custom Color Spoke Pattern		Left Wheel	Right Wheel
Spokes	Inside		
	Outside		
Hub Color		<input type="checkbox"/> Black/ <input type="checkbox"/> Silver	<input type="checkbox"/> Black/ <input type="checkbox"/> Silver

**Spinergy Blade "LXL"
18 Spoke**



- 24" (540) 25" (559) 26" (590)
- Spoke Color Black Red Yellow Blue
 With Silver Hub With Black Hub With Black Hub With Black Hub
 White Neon Green Pink Orange Purple
 With Black Hub With Black Hub With Black Hub With Black Hub With Black Hub

<input type="checkbox"/> Custom Color Spoke Pattern		Left Wheel	Right Wheel
Spokes	Inside		
	Outside		
Hub Color		<input type="checkbox"/> Black	<input type="checkbox"/> Black

HANDRIM

Type

- Standard For 24", 25" or 26" Wheel Anodized Black
- Vinyl Coated For 24", 25" & 26" Wheels Not available with Y-360 Billet Wheels
- Spinergy Silver Brushed Anodized For 24", 25" & 26" Not available with Y-360 Billet Wheels
- Natural Fit For 24", 25" & 26" Wheel
- Standard Grip (Not available with short tabs.) Not available with Y-360 Billet Wheels
 - Super Grip (Not available with short tabs.) Not available with Y-360 Billet Wheels
 - Without Thumb Grip (Not available with Y-360 Billet Wheels)
- Natural Fit(LT) For 24", 25" & 26" Wheel
- Standard Grip (Not available with short tabs.) Not available with Y-360 Billet Wheels
 - Super Grip (Not available with short tabs.) Not available with Y-360 Billet Wheels
 - Without Thumb Grip (Not available with Y-360 Billet Wheels)
- The Surge Handrims * Not available with Y-360 Billet Wheels
- The Surge Handrims (LT) * Not available with Y-360 Billet Wheels
- Spinergy Flex Rim Available only on Spinergy LX & XLX
- The Q-Grip Handrims : anti-slip, latex-free, neoprene coating
 * Not available with Y-360 Billet Wheels
- OMIT HANDRIMS

TAB LENGTH

- Long Tab (STD inside clearance 3/4") Not available with Y-360 Billet Wheels *
- Short Tab (Inside clearance 1/2") * Not available with Natural Fit Handrim with thumb grip
- Short Tab (Set closest to wheel cut off excess) * Not available with Y-360 wheel

G CHAIR OPTIONS 1 / 3

SEAT CUSHION	
SUPRACOR® WHEELCHAIR CUSHIONS	
Stimulite® Contoured Cushion *Black Upholstery only *Comes with Zipper Pouch <input type="checkbox"/> Extra Sensitive (\$35 up charge) <input type="checkbox"/> Sling Style Bottom (\$52 up charge) <input type="checkbox"/> Custom Size (\$- CFP) W(") x D(") <input type="checkbox"/> Extra Cover (\$104 up charge)	<input type="checkbox"/> W14"xD16" (CD1416) E2603 <input type="checkbox"/> W16"xD16" (CD1616) E2603 <input type="checkbox"/> W16"xD18" (CD1618) E2603 <input type="checkbox"/> W18"xD16" (CD1816) E2603 <input type="checkbox"/> W18"xD18" (CD1818) E2603 <input type="checkbox"/> W18"xD20" (CD1820) E2603 <input type="checkbox"/> W20"xD16" (CD2016) E2603 <input type="checkbox"/> W20"xD18" (CD2018) E2603 <input type="checkbox"/> W20"xD20" (CD2020) E2603
Stimulite® Slimline Cushion *Black Upholstery only <input type="checkbox"/> Extra Sensitive (\$35 up charge) <input type="checkbox"/> Sling Style Bottom (\$52 up charge) <input type="checkbox"/> Custom Size (\$- CFP) W(") x D(") <input type="checkbox"/> Extra Cover (\$75 up charge)	<input type="checkbox"/> W14"xD16" (SM1416) E2603 <input type="checkbox"/> W16"xD16" (SM1616) E2603 <input type="checkbox"/> W16"xD18" (SM1618) E2603 <input type="checkbox"/> W18"xD18" (SM1818) E2603 <input type="checkbox"/> W18"xD20" (SM1820) E2603 <input type="checkbox"/> W20"xD16" (SM2016) E2603 <input type="checkbox"/> W20"xD18" (SM2018) E2603 <input type="checkbox"/> W20"xD20" (SM2020) E2603
Stimulite® Corbee Pediatric *Black Upholstery only <input type="checkbox"/> Extra Cover (\$75 up charge)	<input type="checkbox"/> W10"xD10" (PD1010) E2603 <input type="checkbox"/> W12"xD12" (PD1212) E2603 <input type="checkbox"/> W14"xD14" (PD1414) E2603 <input type="checkbox"/> Extra Sensitive (\$35 up charge) <input type="checkbox"/> Sling Style Bottom (\$52 up charge) <input type="checkbox"/> Custom Size W(") x D(") (\$- CFP)
ROHO WHEELCHAIR CUSHIONS	
<input type="checkbox"/> 4" HIGH PROFILE® QUADTRO SELECT® CUSHION *Black Upholstery <input type="checkbox"/> Extra Cover (\$+57) only. E2622-2623	
Choose Size	<input type="checkbox"/> W12"xD12" <input type="checkbox"/> W12"xD13" <input type="checkbox"/> W13"xD13" <input type="checkbox"/> W13"xD15" <input type="checkbox"/> W13"xD16" <input type="checkbox"/> W15"xD13" <input type="checkbox"/> W15"xD15" <input type="checkbox"/> W15"xD16" <input type="checkbox"/> W15"xD18" <input type="checkbox"/> W16"xD15" <input type="checkbox"/> W16"xD16" <input type="checkbox"/> W16"xD18" <input type="checkbox"/> W16"xD20" <input type="checkbox"/> W18"xD15" <input type="checkbox"/> W18"xD16" <input type="checkbox"/> W18"xD18" <input type="checkbox"/> W18"xD20" <input type="checkbox"/> W18"xD22" <input type="checkbox"/> W20"xD16" <input type="checkbox"/> W20"xD18" <input type="checkbox"/> W20"xD20" <input type="checkbox"/> W20"xD22" <input type="checkbox"/> W22"xD18" <input type="checkbox"/> W22"xD20" <input type="checkbox"/> W22"xD22" <input type="checkbox"/> Custom Size W(") x D(") (\$+CFP)
Choose Size	<input type="checkbox"/> 3" MID PROFILE® QUADTRO SELECT® CUSHION *Black Upholstery only <input type="checkbox"/> Extra Cover E2622-2623 <input type="checkbox"/> W15"xD15" <input type="checkbox"/> W15"xD16" <input type="checkbox"/> W16"xD16" <input type="checkbox"/> W16"xD18" <input type="checkbox"/> W18"xD16" <input type="checkbox"/> W18"xD18" <input type="checkbox"/> Custom Size W(") x D(") (\$+CFP)
Choose Size	<input type="checkbox"/> 2" LOW PROFILE® QUADTRO SELECT® CUSHION *Black Upholstery only <input type="checkbox"/> Extra Cover (\$+57) E2622-2623 <input type="checkbox"/> W12"xD12" <input type="checkbox"/> W12"xD13" <input type="checkbox"/> W13"xD13" <input type="checkbox"/> W13"xD15" <input type="checkbox"/> W13"xD16" <input type="checkbox"/> W15"xD13" <input type="checkbox"/> W15"xD15" <input type="checkbox"/> W15"xD16" <input type="checkbox"/> W15"xD18" <input type="checkbox"/> W16"xD15" <input type="checkbox"/> W16"xD16" <input type="checkbox"/> W16"xD18" <input type="checkbox"/> W16"xD20" <input type="checkbox"/> W18"xD15" <input type="checkbox"/> W18"xD16" <input type="checkbox"/> W18"xD18" <input type="checkbox"/> W18"xD20" <input type="checkbox"/> W20"xD16" <input type="checkbox"/> W20"xD18" <input type="checkbox"/> W20"xD20" <input type="checkbox"/> Custom Size W(") x D(") (\$+CFP)
STAR CUSHIONS	
Galaxy Cushion *Black Upholstery only <input type="checkbox"/> W14"xD14" (GXY 1414-2) <input type="checkbox"/> W14"xD16" (GXY 1416-2) <input type="checkbox"/> W16"xD14" (GXY 1614-2) <input type="checkbox"/> W16"xD16" (GXY 1616-2) <input type="checkbox"/> W16"xD18" (GXY 1618-2) <input type="checkbox"/> W18"xD16" (GXY 1816-2) <input type="checkbox"/> W18"xD18" (GXY 1818-2) <input type="checkbox"/> W18"xD20" (GXY 1820-2) <input type="checkbox"/> W20"xD16" (GXY 2016-2) <input type="checkbox"/> W20"xD18" (GXY 2018-2) <input type="checkbox"/> W20"xD20" (GXY 2020-2)	Choose Zoning Options E2624 <input type="checkbox"/> Standard - Dual Valve <input type="checkbox"/> Dual Valve - Front to Back <input type="checkbox"/> Four Valve <input type="checkbox"/> Simple - Single Valve <input type="checkbox"/> Four Valve - Enhanced <input type="checkbox"/> Four Valve - Front to Back
THE CURVE CUSHION *Black Upholstery only <input type="checkbox"/> Extra Cover (\$+ 40	<input type="checkbox"/> W10"xD10" <input type="checkbox"/> W10"xD11" <input type="checkbox"/> W10"xD11" <input type="checkbox"/> W10"xD12" <input type="checkbox"/> W11"xD12" <input type="checkbox"/> W12"xD12" <input type="checkbox"/> W12"xD13" <input type="checkbox"/> W12"xD14" <input type="checkbox"/> W13"xD11" <input type="checkbox"/> W13"xD12" <input type="checkbox"/> W13"xD13" <input type="checkbox"/> W13"xD14" <input type="checkbox"/> W14"xD14" <input type="checkbox"/> W14"xD15" <input type="checkbox"/> W14"xD16" <input type="checkbox"/> W15"xD14" <input type="checkbox"/> W15"xD15" <input type="checkbox"/> W15"xD16" <input type="checkbox"/> W16"xD14" <input type="checkbox"/> W16"xD15" <input type="checkbox"/> W16"xD16" <input type="checkbox"/> W16"xD17" <input type="checkbox"/> W16"xD18" <input type="checkbox"/> W17"xD16" <input type="checkbox"/> W17"xD17" <input type="checkbox"/> W17"xD18" <input type="checkbox"/> W18"xD16" <input type="checkbox"/> W18"xD17" <input type="checkbox"/> W18"xD18"

Valid from 2022 Prices & Specifications Are Subject To Change Without

G CHAIR OPTIONS 2 / 3

SEAT CUSHION	
Exgel Kaji Cushion	
For Comfortable Sitting To Prevent Pressure Sores <input type="checkbox"/> Owl Regular(1.6" Thick) Incontinence Cover Only	<input type="checkbox"/> W14"xD16" E2603 <input type="checkbox"/> W15"xD16" E2603 <input type="checkbox"/> W16"xD16" E2603 <input type="checkbox"/> W18"xD16" * No Custom Sizes E2603
<input type="checkbox"/> Owl High(3.1" Thick) Incontinence Cover Only	<input type="checkbox"/> W14"xD16" E2603 <input type="checkbox"/> W15"xD16" E2603 <input type="checkbox"/> W16"xD16" E2603 <input type="checkbox"/> W18"xD16" E2603 <input type="checkbox"/> W18"xD18" * No Custom Sizes E2603
<input type="checkbox"/> Owl Contour(4.3" Thick) Incontinence Cover Only	<input type="checkbox"/> W14"xD16" E2603 <input type="checkbox"/> W15"xD16" E2603 <input type="checkbox"/> W16"xD16" E2603 <input type="checkbox"/> W18"xD16" E2603 * No Custom Sizes
<input type="checkbox"/> Owl Deep Contour(4.3" Thick) <input type="checkbox"/> W14"xD16" \$ 458 * No Custom Sizes- Incontinence Cover Only <input type="checkbox"/> W14"xD16" \$518 <input type="checkbox"/> W15"xD16" \$518 <input type="checkbox"/> W16"xD16" \$518 <input type="checkbox"/> W18"xD16" \$558	
<input type="checkbox"/> Standard Regular(1.4" Thick) Easy to Use Flat Style (superior pressure redistribution) For Pressure E2622-2623 <input type="checkbox"/> W12" x D12" \$368 <input type="checkbox"/> W13" x D13" \$368 <input type="checkbox"/> W14" x D14" \$368 <input type="checkbox"/> W14" x D16" \$368 <input type="checkbox"/> W16" x D16" \$368 <input type="checkbox"/> W16" x D17" \$368 <input type="checkbox"/> W17" x D16" \$368 <input type="checkbox"/> W17" x D17" \$368 <input type="checkbox"/> W18" x D16" \$391 <input type="checkbox"/> W18" x D18" \$391 <input type="checkbox"/> W18" x D19" \$440 <input type="checkbox"/> W18" x D20" \$440 <input type="checkbox"/> W19" x D19" \$440 * No Custom Sizes- Incontinence Cover Only	
<input type="checkbox"/> Standard High(2.6" Thick) Incontinence Cover Only E2622 *Black Upholstery only <input type="checkbox"/> W12" x D12" \$383 <input type="checkbox"/> W13" x D13" \$ 383 <input type="checkbox"/> W14" x D14" \$383 <input type="checkbox"/> W14" x D16" \$ 383 <input type="checkbox"/> W16" x D16" \$383 <input type="checkbox"/> W16" x D17" \$383 <input type="checkbox"/> W17" x D16" \$383 <input type="checkbox"/> W17" x D17" \$383 <input type="checkbox"/> W18" x D16" \$460 <input type="checkbox"/> W18" x D18" \$460 <input type="checkbox"/> W18" x D19" \$512 <input type="checkbox"/> W18" x D20" \$512 <input type="checkbox"/> W19" x D19" \$512 <input type="checkbox"/> W18" x D19" \$512	
<input type="checkbox"/> Standard Anti-Thrust(2.6" Thick) * No Custom Sizes Incontinence Cover Only	<input type="checkbox"/> W16 x D16 \$460 Prevents Unwanted <input type="checkbox"/> W18 x D16 \$500 Forward Movement of <input type="checkbox"/> W18 x D18 \$500 lower back and hip bone
<input type="checkbox"/> Lite Regular(2.2" Thick) <input type="checkbox"/> W16" x D16" \$374 <input type="checkbox"/> W18" x D16" \$397 <input type="checkbox"/> W18" x D18" \$397 * No Custom Sizes- Incontinence Cover Only	
<input type="checkbox"/> Lite High(3.0" Thick) <input type="checkbox"/> W16" x D16" \$408 <input type="checkbox"/> W18" x D16" \$431 <input type="checkbox"/> W18" x D18" \$431 * No Custom Sizes- Incontinence Cover Only	

H CHAIR OPTIONS 3 / 3

POSITIONING BACK

***Note : Actual height of the backrest will increase 2" or more.**

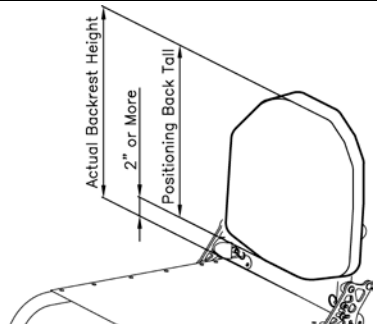

ADI CARBON BACKREST (Support Contour-ACTIVE 2.5") *Not Available with Welded Side Guards

Mounting Hardware: 2 Point Pro Quick Release

<input type="checkbox"/> Add Privacy Flap (\$69 up charge)	Height	<input type="checkbox"/> LOW (10" Tall) *Backrest Height requires 12" or more *Available 13"-19" width	Width (")	E2613
		<input type="checkbox"/> Medium (13" Tall) *Backrest Height requires 15" or more *Available 13"-19" width	Width (")	E2613
		<input type="checkbox"/> Standard (16" Tall) *Backrest Height requires 18" or more *Available 13"-19" width	Width (")	E2613
		<input type="checkbox"/> Custom Size (" Tall) x (" width)		E2613

ADI ALUMINUM BACKREST (Support Contour-ACTIVE 2.5") *Not Available with Welded Side Guards

Mounting Hardware: 2 Point Pro Quick Release

<input type="checkbox"/> Add Privacy Flap (\$69 up charge)	Height	<input type="checkbox"/> LOW (10" Tall) *Backrest Height requires 12" or more *Available 10"-20" width	Width (")	E2613
		<input type="checkbox"/> Medium (13" Tall) *Backrest Height requires 15" or more *Available 12"-20" width	Width (")	E2613
		<input type="checkbox"/> Standard (16" Tall) *Backrest Height requires 18" or more *Available 14"-20" width	Width (")	E2613
		<input type="checkbox"/> Tall (18" Tall) *Backrest Height requires 20" or more *Available 16"-20" width	Width (")	E2613
		<input type="checkbox"/> X-Tall (20" Tall) *Backrest Height requires 22" or more *Available 16"-20" width	Width (")	E2613
		<input type="checkbox"/> Custom Size (" Tall) x (" width)		E2613

ADI ALUMINUM BACKREST (Support Contour-DEEP 4") *Not Available with Welded Side Guards*Not Available with Lateral Supports

Mounting Hardware: 2 Point Pro Quick Release

<input type="checkbox"/> Add Privacy Flap (\$69 up charge)	Height	<input type="checkbox"/> LOW (10" Tall) *Backrest Height requires 12" or more *Available 10"-20" width	Width (")	E2615
		<input type="checkbox"/> Medium (13" Tall) *Backrest Height requires 15" or more *Available 12"-20" width	Width (")	E2615
		<input type="checkbox"/> Standard (16" Tall) *Backrest Height requires 18" or more *Available 14"-20" width	Width (")	E2615
		<input type="checkbox"/> Tall (18" Tall) *Backrest Height requires 20" or more *Available 16"-20" width	Width (")	E2615
		<input type="checkbox"/> X-Tall (20" Tall) *Backrest Height requires 22" or more *Available 16"-20" width	Width (")	E2615
		<input type="checkbox"/> Custom Size (" Tall) x (" width)		E2615

ADI LATERAL SUPPORTS (Lateral Supports are compatible with only active 2.5" ADI positioning back.)

<input type="checkbox"/> Stationary Pad	Pad Size	<input type="checkbox"/> Small (3" H x 3" D) <input type="checkbox"/> Medium(3" H x 4" D) <input type="checkbox"/> Large(4.5" H x 4.5" D) <input type="checkbox"/> Large(4" H x 6" D)
		<input type="checkbox"/> Pair <input type="checkbox"/> Left side only or <input type="checkbox"/> Right side only
<input type="checkbox"/> Swing-Out	Pad Size	<input type="checkbox"/> Small (3" H x 3" D) <input type="checkbox"/> Medium(3" H x 4" D) <input type="checkbox"/> Large(4.5" H x 4.5" D) <input type="checkbox"/> Large(4" H x 6" D)
		<input type="checkbox"/> Pair <input type="checkbox"/> Left side only or <input type="checkbox"/> Right side only

OTHER

- ADI Transfer Board 21" (ADV21) 24" (ADV24) 29" (ADV29).
- ADI Push and Transfer Gloves **Leather** (one size fits)
- ADI Carbon Solid Seat (Wide: 18" Max, Depth: 20") ✘ ONLY AVAILABLE WITH COLOURS NON-REMOVABLE SIDE GUARDS

VARILITE® Seating Systems Available

Please visit for all options. www.varilite.com

NOTE