

## Owner's Manual

---

# Hand-Held Bidet Holster with Integrated Shut Off

BIDET SPRAYER ACCESSORY  
MODELS MBH-10/MBH-37/MBH-40

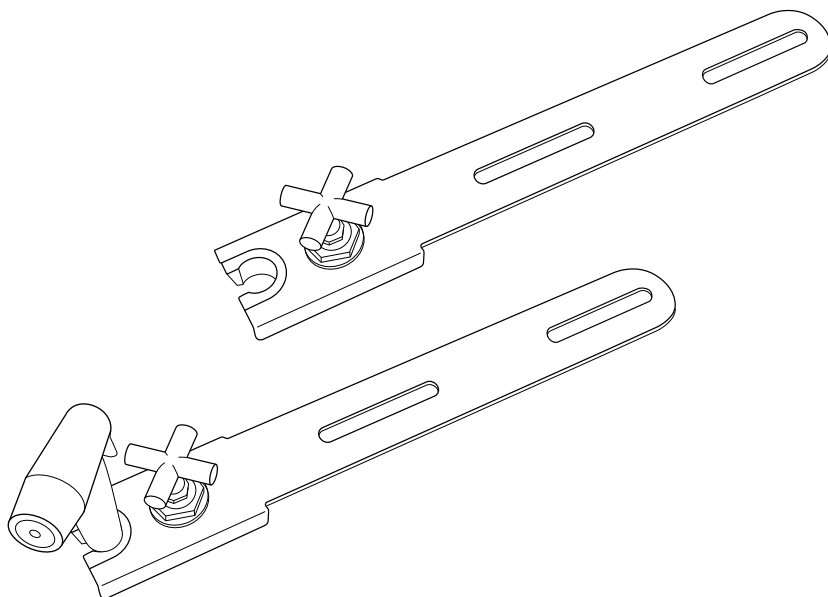

# Table of Contents

This manual contains important safety information. Before operating your Hand-Held Bidet Holster with Integrated Shut Off, please read this manual thoroughly and retain it for future reference.

## GENERAL INFORMATION

- 01 **PRODUCT INFORMATION**
- 01 Product Features
- 02 Product Dimensions
- 03 Product Parts

## TECHNICAL INFORMATION

- 08 **MAINTENANCE**
- 09 **PRODUCT SPECIFICATIONS**
- 10 **WARRANTY**
- 11 **CONTACT**

## PRODUCT INSTALLATION

- 04 **PRODUCT INSTALLATION**
- 04 Before Installation
- 05 Installation

## PRODUCT OPERATION

- 07 **PRODUCT OPERATION**
- 07 Using the Hand-Held Bidet Holster with Integrated Shut Off

## PRODUCT INFORMATION

# Product Features

Polished Stainless Steel Hand-Held Bidet  
Sprayer Mount

Integrated Chrome Water Shut Off Handle

Universal Hand-Held Sprayer Holster Works  
With Any Sprayer

High-Quality Metal  $\frac{7}{8}$ " T-Valve

Durable Braided Metal Cold Water Hose

No Electricity Or Batteries Required

Easy Installation And Adjustable Toilet Fit

One-Year Warranty

# Product Dimensions

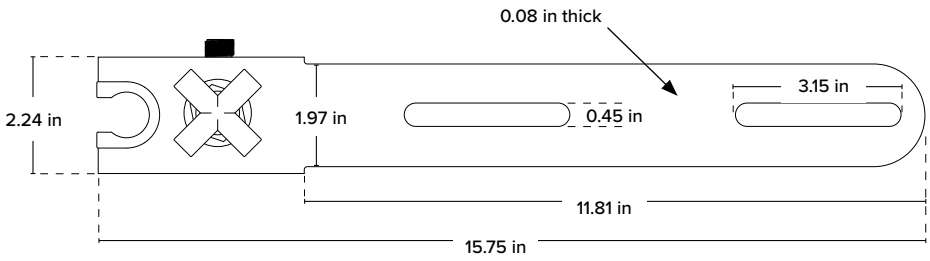

PRODUCT INFORMATION

# Product Parts

1. Stainless Steel Mount
2. Cold Water Braided Metal Hose

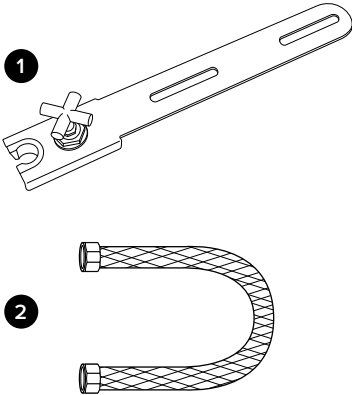

3. Large Rubber Washer (1)
4. Cold Water T-Valve Connector ( $\frac{7}{8}$ " x  $\frac{7}{8}$ " x  $\frac{3}{8}$ " )

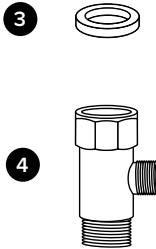

### MBH-37/MBH-40 Only

1. Sprayer Head
2. Metal Sprayer Hose ( $\frac{1}{2}$ " X  $\frac{1}{2}$ " )

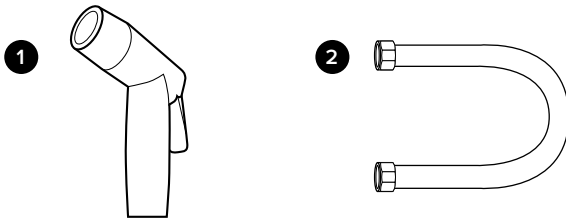

## PRODUCT INSTALLATION

# Before Installation

You must have a CleanSpa hand-held bidet or equivalent product with a ½" connection sprayer hose in order to install the Hand-Held Bidet Holster with Integrated Shut Off.

### IMPORTANT

Please be advised that the provided cold water T-valve should be installed at the fill valve under the toilet tank, NOT at the cold water supply coming from the wall.

### Check Water Supply Line

If the pipe that connects the toilet tank fill valve to the water shutoff valve at the wall is rigid, you will need to purchase a flexible water supply hose to replace it before installing the Hand-Held Bidet Holster with Integrated Shut Off. The length of the hose may vary and the top connection size should be 7/8" ballcock to connect to the T-valve that you will install under the toilet tank and the bottom connection will vary (most common are 3/8" and 1/2" female compression).

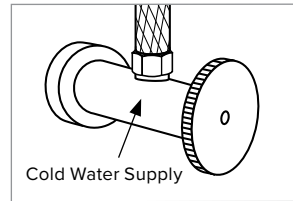

**INCORRECT**

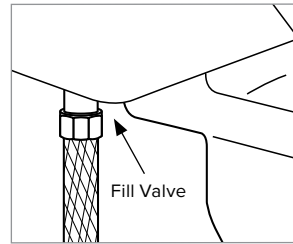

**CORRECT**

## PRODUCT INSTALLATION

# Installation

Please read these instructions carefully before installing your Hand-Held Bidet Holster with Integrated Shut Off. Failure to do so could result in flooding, leaking or damage to the product.

### 1. Existing Toilet Seat Removal

- Lift hinge covers and use flathead or Phillips head screwdriver to remove the mounting bolts. Alternatively, you may need to loosen mounting bolts underneath the seat.
- Remove the toilet seat and set the seat, mounting bolts and hardware aside.

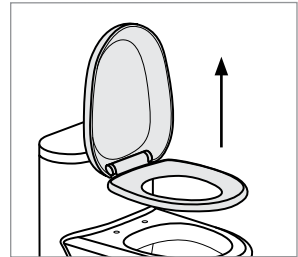

Step 1b

### 2. Turn Off Water Supply Valve and Flush Toilet

- Turn water supply valve off to stop the flow of water.
- Flush toilet and hold down handle to completely empty tank.
- Disconnect water supply hose from toilet tank. Do not disconnect from the water supply valve.
- If you have a hand-held bidet sprayer already connected to your toilet tank, remove the existing T-valve and hand-held bidet sprayer connection hose.

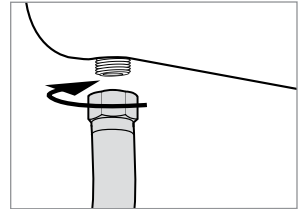

Step 2c

### 3. Connect Cold Water T-Valve to the Toilet Tank Fill Valve

- Install the included  $\frac{7}{8}$ " cold water T-valve with the large rubber washer provided to the incoming water connection on the bottom of your toilet tank.
- Connect the cold water supply line coming from the wall to the bottom of the T-valve.

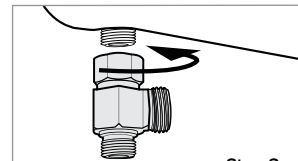

Step 3a

### 4. Connect Cold Water Hose to T-Valve

Connect one end of the Cold Water Braided Metal Hose to the remaining open side of the installed T-valve.

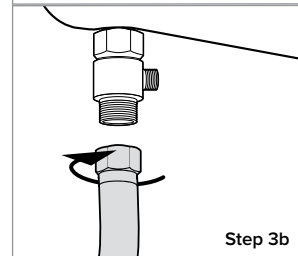

Step 3b

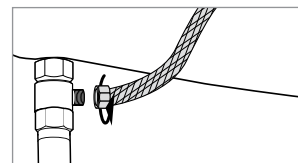

Step 4

# Installation

## Installing the Hand-Held Bidet Holster

1. Install Hand-Held Bidet Holster on Toilet
  - a. Place Hand-Held Bidet Holster on the toilet so the mounting slots line up with the holes in the toilet fixture.
  - b. Replace the toilet seat on top of Hand-Held Bidet Holster and secure using original toilet seat hardware. Make sure to tighten so that the holster and seat do not move.
  
2. Connect Cold Water Hose to Hand-Held Bidet Holster  
Attach the open end of the Cold Water Braided Metal Bidet Hose to the incoming water connection on the side of the holster.
  
3. Connect Hand-Held Bidet Sprayer to Holster
  - a. Connect your hand-held bidet sprayer to the sprayer hose.
  - b. Connect the open end of the sprayer hose to the  $\frac{1}{2}$ " connection at the bottom of the holster.
  - c. Place the hand-held bidet sprayer in the holster slot.
  
4. Turn on Water Supply & Check for Leaks
  - a. Open the main water supply valve slowly and check for leaks.
  - b. Wait 5-10 minutes, check again, and if there are no leaks, continue.

**NOTE:** If there is any leaking, check all rubber washers and make sure all water connections are tight and secure. If necessary, you can use plumbers tape for any leaking connections.

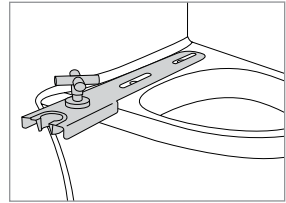

Step 1a

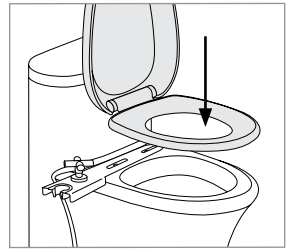

Step 1b

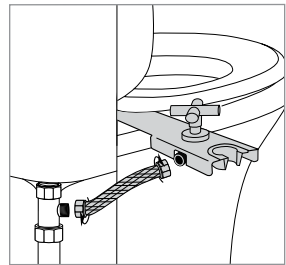

Step 2

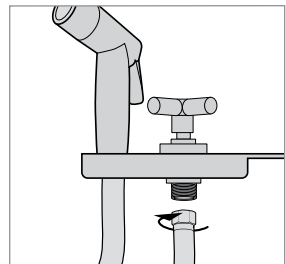

Step 3b



## PRODUCT OPERATION

# Using the Hand-Held Bidet Holster with Integrated Shut Off



**WARNING: The faucet handle must be turned off after each use.**  
**Failure to turn off after each use may cause flooding and water damage.**



To engage your hand-held bidet, turn on the integrated shut off faucet handle located on the metal holster.

Remove the sprayer from the holster and use in normal fashion.

When finished, replace the sprayer in the holster and turn off the integrated shut off faucet handle.

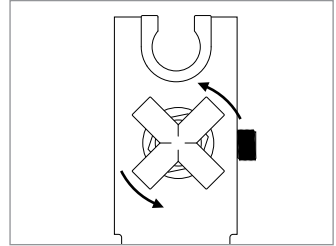

On

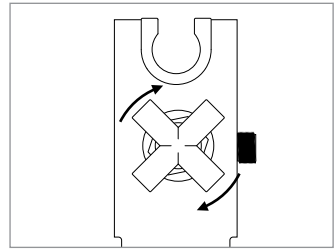

Off

# Maintenance

To clean the Hand-Held Bidet Holster with Integrated Shut Off, use a mild cleaner such as Simple Green or Windex spray. Do not scrub or use harsh, abrasive products to clean the Hand-Held Bidet Holster with Integrated Shut Off, which may scratch the product.

## Short Term Non-Use

If the product will not be used for more than a few weeks, you may consider shutting the water supply off at the wall as an additional precaution.

# Product Specifications

## HAND-HELD BIDET HOLSTER WITH INTEGRATED SHUT OFF

<b>Models</b>	MBH-10, MBH-37, MBH-40
<b>Supply Water Pressure</b>	20 psi–100 psi / 0.14 MPa–0.69 MPa
<b>Incoming Water Temperature Range</b>	32 °F–158 °F / 0 °C–70 °C
<b>Product Dimension</b>	15.75 in x 2.24 in / 40 cm x 6 cm
<b>Product Thickness</b>	0.08 in / 0.2 cm
<b>Product Weight</b>	MBH-10: 1.14 lb / 0.7 kg MBH-37: 2.23 lb / 1.02 kg MBH-40: 2.29 lb / 1.04 kg

**NOTE:** The specifications listed above are subject to change without prior notice for reasons of improving the product performance.

# Warranty

Brondell products are backed by some of the most comprehensive warranties in the industry. Brondell warrants that all products (excluding consumable items) shall be free from defects in material and workmanship under normal use and service.

## **MBH-10/MBH-37/MBH-40 RESIDENTIAL ONE-YEAR LIMITED WARRANTY**

100% Coverage of all parts and labor for the entire product for the first year from original date of purchase.

## **MBH-10/MBH-37/MBH-40 COMMERCIAL WARRANTY**

Warranty period 1 year from original purchase date for all Brondell products. Warranties may not apply to products that are used for heavy commercial, hospital, or other high use non-residential applications.

## **EXCLUSIONS AND LIMITATIONS**

1. Brondell warrants its products to be free from manufacturing defects under normal use and service. This warranty is extended only to the ORIGINAL PURCHASER.
2. Brondell's obligations under this warranty are limited to repairs or replacement, at Brondell's option, of products or parts found to be defective, provided that such products were properly installed and used in accordance with instructions. Brondell reserves the right to make such inspections as may be necessary in order to determine the cause of the defect.
3. Brondell is not responsible for the cost of removal, return (shipping) and/or re-installation of products.

This warranty does NOT apply to:

- Damage or loss which occurs during shipment.
  - Damage or loss sustained through any natural or man-made causes beyond the control of Brondell, including but not limited to fire, earthquake, floods, etc.
  - Damage or loss resulting from sediments or foreign matter contained in a water system.
  - Damage or loss resulting from negligent or improper installation including installation of a unit in a harsh or hazardous environment.
  - Damage or loss resulting from removal, improper repair, modification of the product, or improper maintenance including damage caused by chlorine or chlorine related products.
4. This warranty gives you specific legal rights. You may have other rights which vary from state to state.

THIS WRITTEN WARRANTY IS THE ONLY WARRANTY MADE BY BRONDELL. REPAIR OR REPLACEMENT AS PROVIDED UNDER THIS WARRANTY SHALL BE THE EXCLUSIVE REMEDY AVAILABLE TO THE PURCHASER. BRONDELL SHALL NOT BE RESPONSIBLE FOR LOSS OF USE OF THE PRODUCT OR FOR OTHER INCIDENTAL, SPECIAL, FOR CONSEQUENTIAL DAMAGES OR EXPENSES INCURRED BY THE PURCHASER OR FOR LABOR OR OTHER COSTS DUE TO INSTALLATION OR REMOVAL OR COSTS OF REPAIRS BY OTHERS, OR FOR ANY OTHER EXPENSE NOT SPECIFICALLY STATED ABOVE. EXCEPT TO THE EXTENT PROHIBITED BY APPLICABLE LAW, ANY IMPLIED WARRANTIES, INCLUDING THAT OF MERCHANTABILITY, ARE EXPRESSLY LIMITED TO THE DURATION OF THIS WARRANTY. SOME STATES DO NOT ALLOW LIMITATIONS, SO THE ABOVE LIMITATION AND EXCLUSION MAY NOT APPLY TO YOU.

## **HOW TO OBTAIN SERVICE**

To obtain repair service under this warranty, you must contact an authorized Brondell Service Center to obtain an RMA (Return Merchandise Authorization) number. Proof of purchase in the form of a copy of the original receipt must accompany the returned unit for the warranty to be valid. Take or ship the unit prepaid to the closest Brondell authorized service center along with the RMA number and proof of purchase.