

clarity[®]

Clarity Products LLC

©2020 Clarity Products LLC. Clarity, Clarity Professional, XLC8,XLC8HS, XLCgo and the amplified figure are trademarks or registered trademarks of Clarity Products LLC. Other trademarks and trade names are those of their respective owners.

Specifications are subject to change without notice.

Rev. A (01-2020)

Printed in China

User Guide

XLC8™

Home and
cellphone calls
Amplified.

MAKE CALLS WITH AND
WITHOUT A LANDLINE

PAIR UP TO TWO (2)
WIRELESS ENABLED DEVICES

50 DB OF AMPLIFICATION AND
FOUR (4) TONE SETTINGS

EXPANDABLE UP TO THREE
(3) EXTRA HANDSETS
(XLC8HS®)

clarity®



E
N
G
L
I
S
H



Important Safety Instructions	2
Contents & Parts Checklist	5
Installation	6
Wall Mounting Your XLC8	8
Base - Quick Reference Guide	10
Handset - Quick Reference Guide	11
Battery Information	14
Wireless Enabled Function	15
Placing & Answering Calls	16
Volume and Tone Adjustments	17
Caller ID Function	18
Slow Button	18
Phonebook	19
Screen Details	19
Telephone Menu	20
Handset Registration	31
Troubleshooting	32
Technical Information	35
Regulatory Compliance	36
Warranty Information	39

When using your telephone equipment, basic safety precautions should always be followed to reduce the risk of fire, electric shock and injury to persons, including the following:

1. Read and understand all instructions.
2. Follow all warnings and instructions marked on the telephone.
3. Avoid contact with liquids. Do not locate base unit or handset near water, for example, near a bathtub, wash basin, sink or laundry tub, in a wet basement or near a swimming pool.
4. Avoid using a telephone (other than a cordless type) during a storm. There may be a remote risk of electrical shock from lightning.
5. Do not use the telephone to report a gas leak in the vicinity of the leak.
6. Unplug this telephone from the wall outlets before cleaning. Do not use liquid cleaners or aerosol cleaners on the telephone. Use a damp cloth for cleaning.
7. Place this telephone on a stable surface. Serious damage and/or injury may result if the telephone falls.
8. Do not cover the slots and openings on this telephone. This telephone should never be placed near or over a radiator or heat register. This telephone should not be placed in a built-in installation unless proper ventilation is provided.
9. Operate this telephone using the electrical voltage as stated on the base unit or the owner's manual. If you are not sure of the voltage in your home, consult your dealer or local power company.
10. Do not allow anything to rest on the power cord or locate this product in an area where the power cord is likely to be damaged by furniture or foot traffic.
11. Do not overload wall outlets or extension cords as this can increase the risk of fire or electrical shock.
12. Never push any objects through the slots in the telephone. They can touch dangerous voltage points or short out parts that could result in a risk of fire or electrical shock. Never spill liquid of any kind on the telephone.
13. To reduce the risk of electrical shock, do not take this phone apart. Opening or removing covers may expose you to dangerous voltages or other risks. Incorrect reassembly can cause electric shock when the appliance is subsequently used.
14. Unplug this product from the wall outlet and refer servicing to the manufacturer under the following conditions: when the power supply cord or plug is frayed or damaged; if liquid has been spilled into the

SAVE THESE INSTRUCTIONS

- product; if the telephone has been exposed to rain or water; if the telephone has been dropped or the case has been damaged; if the telephone exhibits a distinct change in performance; if the telephone does not operate normally by following the operating instructions. Adjust only those controls that are covered by the operating instructions. Improper adjustment may require extensive work by a qualified technician to restore the telephone to normal operation if the telephone does not operate normally by following the operating instructions.
15. This product should be operated only from the type of power source indicated on the marking label. If you are not sure of the type of power supply to your home, consult your local power company.
 16. Do not attempt to open the AC adapter. There are potentially dangerous voltages inside, and there are no serviceable parts.
 17. Discontinue use of product and contact Clarity if the product overheats, has a damaged cord or plug, if the product has been dropped or damaged or if the product has come into contact with liquids.
 18. Use only the AC adapter provided with this product or a replacement AC adapter provided by Clarity.
 19. This phone amplifies sound to loud volumes. To prevent hearing damage, all users of the phone should be informed of the high volume capability of the phone and children should only use the phone when supervised by an adult.
 20. Exposure to high volume sound levels or excessive sound pressure may cause temporary or permanent damage to your hearing. Although there is no single volume setting that is appropriate for everyone, you should always use your telephone with the volume set at moderate levels and avoid prolonged exposure to high volume sound levels. The louder the volume, the less time is required before your hearing could be affected. If you experience hearing discomfort, you should have your hearing checked by a doctor. To protect your hearing, you should:
 - A) Set the volume control in a low position and gradually increase the volume as needed. Before pressing the **BOOST** button, reduce the volume to the lowest level. Use the phone on the lowest volume setting as possible.
 - B) Limit the amount of time you use the telephone at high volume levels.
 21. If you experience a skin irritation after using this product, discontinue use and contact Clarity.
 22. Adapter statements:
 - A) For pluggable equipment, the socket-outlet (power adapter) shall be installed near the equipment and shall be easily accessible
 23. The equipment is only use for mounting at heights <2m

BATTERY SAFETY INSTRUCTIONS

Dispose of used batteries according to the instructions.



Caution: Disconnect telephone line before replacing batteries.

1. Do not dispose of the battery in a fire as it may explode. Check with local codes for possible special disposal instructions.
2. Do not open or mutilate the battery. Released electrolyte is corrosive and may cause damage to the eyes and skin. It may be toxic if swallowed.
3. Exercise care in handling batteries in order not to short the battery with conducting materials such as rings, bracelets and keys. The battery or conduction material may overheat and cause burns.
4. Remove batteries when they are discharged and when the equipment will not be used for an extended period of time. Dispose of batteries according to local environmental laws.
5. Do not disassemble, heat, crush, deform or puncture batteries.
6. Do not attempt to charge non-rechargeable batteries.
7. Keep batteries out of the reach of children.

WARNING: Risk of explosion if battery is replaced by an incorrect type.

SAVE THESE INSTRUCTIONS



Base



Handset

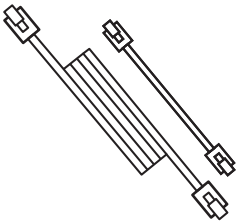

Phone cords (1 long, 1 short)

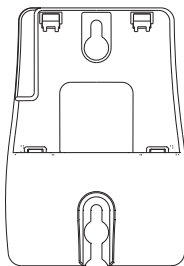

Wall mount bracket

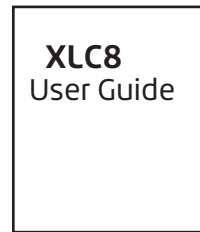

User guide

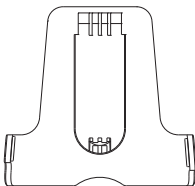

Belt clip

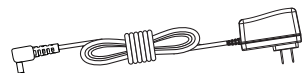

AC power adapter

Your telephone should arrive pre-assembled. To install it:

1. Remove base from package; pull yellow tab in the direction of the arrow.
2. Hold one end of your **XLC8**'s long phone line cord tightly. The correct end to hold should already be plugged into your phone's jack. Simultaneously pull the other end of the phone cord away from the phone, unraveling it and allowing you to plug that end of the cord into a wall telephone outlet.
3. Plug the loose end of the phone cord into the wall telephone outlet.
4. Hold one end of your phone's black power adapter cord tightly. The correct end to hold should already be plugged into the back of your telephone base unit. Simultaneously pull the other end of the adapter cord away from the phone, unraveling it and allowing you to plug that end of the cord into a wall electrical outlet.
5. Plug black power adapter cord on left rear of the base into a wall electrical outlet.
6. Remove handset from package.
7. Pull the handset's battery tab located on the bottom of the device in the direction of the arrow.
8. Place the handset in the base charger. The batteries in the handset must be fully charged for 16 hours before using the telephone for the first time.
9. Lift handset and press **TALK** to test. If you hear a dial tone, your telephone is ready for use. If not, check all connections again.

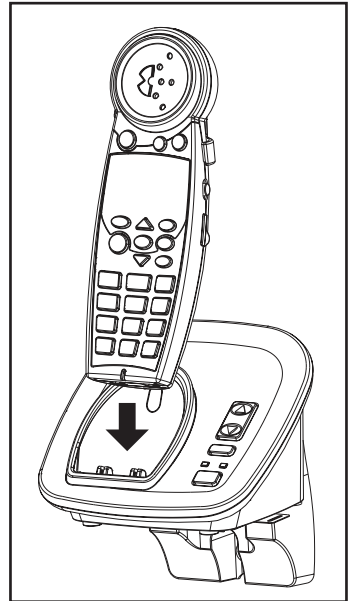
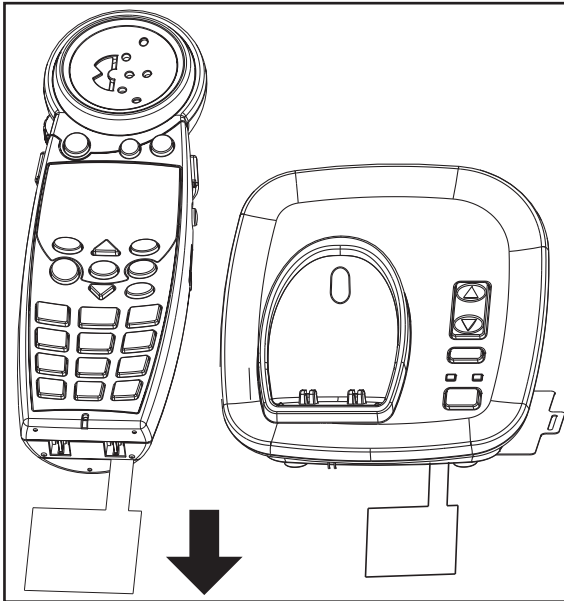
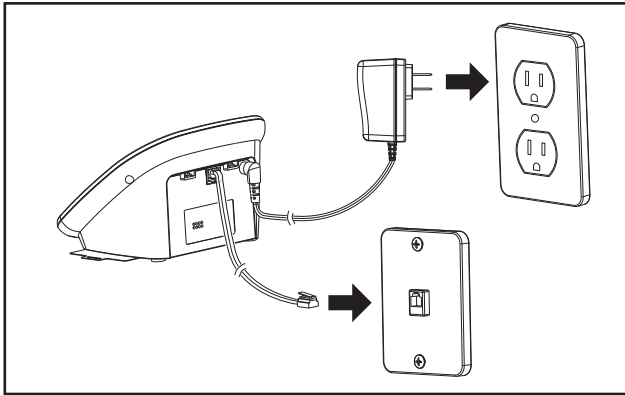
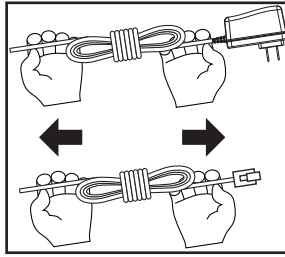

1. Follow the instructions in the Installation section to remove the base and handset from the base – steps 1, 4, 6.
2. Unplug the long phone line cord from the phone jack located on the back of your **XLC8**. Plug one end of the short phone line cord into the same jack identified by LINE on the back of your base.
3. Install the **XLC8** base onto the wall mount bracket as shown. Guide the short phone cord through the wall mount bracket as shown in the diagram.
4. Using a screwdriver, loosen the screws on your phone wall outlet (1-2 turns).
5. Plug the loose end of the short phone cord into the wall phone outlet.
6. Attach the wall mount bracket (with the **XLC8** base) onto the wall phone outlet.
7. Plug the power adapter into a wall electrical outlet.
8. Pull the handset's battery tab located on the bottom of the device in the direction of the arrow.
9. Place the handset in the base and allow 16 hours for full charge.

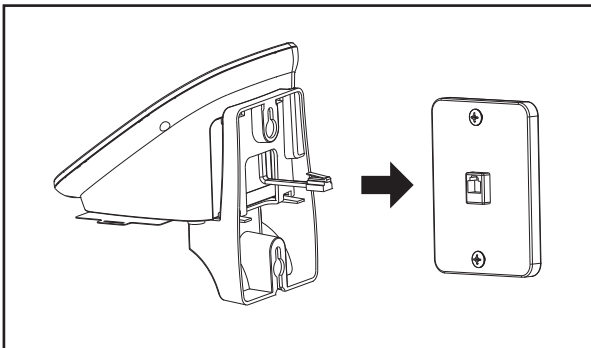
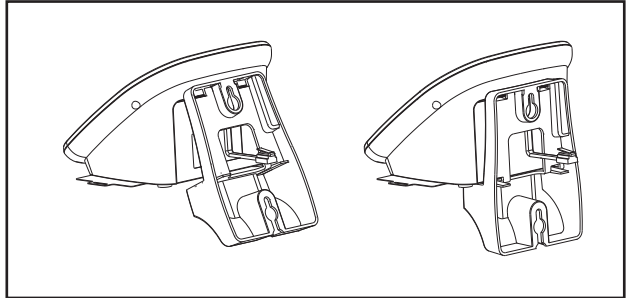
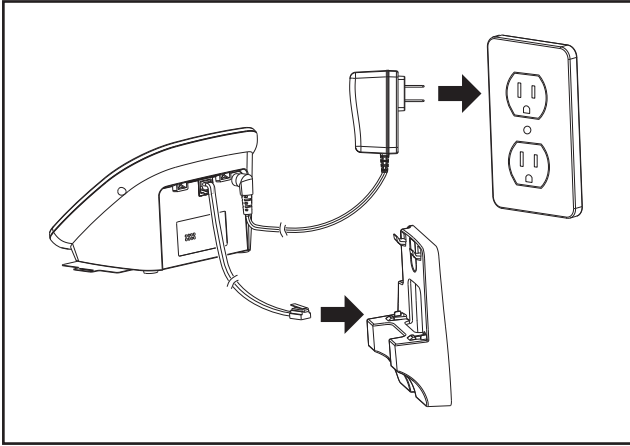

1 Visual Ringer

Lights up when phone rings; turns on when phone is in use.

2 IN USE / CHARGE Light

The light turns red when the phone is charging, and it turns green when the phone is in use.

3 POWER Light

Light is lit green when the power adapter is plugged in.

During a power outage, the **POWER** light will blink green once every two seconds when base backup batteries are installed.

4 ANSWERING MACHINE DISPLAY

Shows number of messages and if machine is on or off

5 SILENT/MUTE

Press if you want to turn off the base ringer or to mute while on base speakerphone

6 SLOW

Press to slow down messages

7 CALL BLOCK

Press to block calls

8 SPEAKERPHONE

Press to use the speakerphone on the base

9 REWIND/FAST FORWARD

Use these keys rewind or fast forward messages; skip and go back

10 DELETE

Use this to delete messages

11 PLAY/STOP

Press to play and stop messages

12 VOLUME (UP / DOWN)

Use these keys to increase or decrease the ringer volume.

13 WIRELESS ENABLED PAIR BUTTONS (1,2)

Use these keys to pair the wireless enabled cellphone(s)

14 RINGER STYLE (Base)

Use this key to choose the base ring tone. There are six ring tones available.

NOTE (Base): You can only set the ringer volume or style when the phone is not in use.

15 FIND

Press this key to locate the handset

16 ON/OFF

Press to turn answering machine on and off

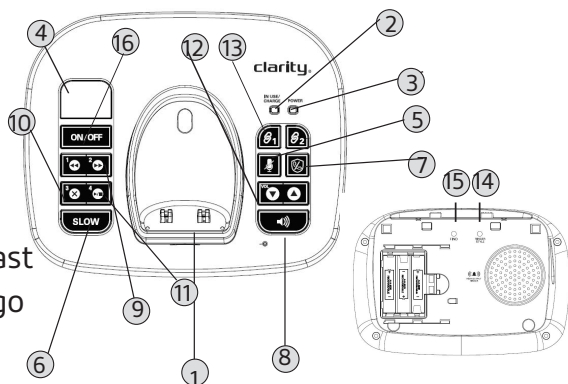

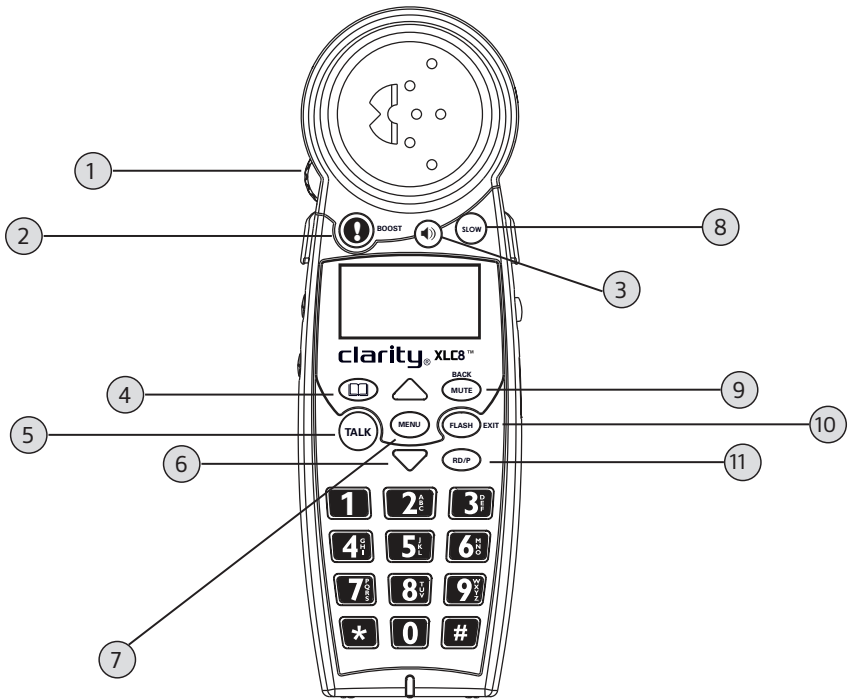

1 VOLUME Control Wheel

Use the rotary control to increase or decrease the volume of the incoming call. The volume level is displayed on the screen, lower right corner.

2 BOOST

Press this button to engage the extra amplification. The **BOOST** button turns red when Boost function is active. Warning: the handset is at high volume when BOOST is on, which may damage user with normal hearing.

3 Speaker

During a call, press to activate handset speakerphone. Press again to switch back to earpiece.

When in speakerphone mode, the speakerphone icon is displayed on the screen (to the left of the battery icon), and the speakerphone button lights up red.

4 Phonebook

This button allows you to access your XLC8's list of saved names and numbers.

5 TALK

This button allows you to make or answer phone calls. It lights up green during a call.

6 Arrow Buttons (UP / DOWN)

Press **UP** or **DOWN** arrows to navigate through the menus.

In standby mode, press **UP** or **DOWN** to access your Caller List.

7 MENU Button

Press this button to engage your phone's available options.

8 SLOW Button: press this button to slow down live conversations**9 MUTE / BACK (EDIT) Button**

Mute: Allows you to conduct private conversations you don't want heard (during a call).

Back: In **MENU** mode, allows you to return to the previous screen.

(Edit): When a phone number is displayed, allows you to toggle between 7/10/11 digit formats for the number you are viewing.

10 FLASH / EXIT

FLASH: While on a call, press **FLASH / EXIT** to receive another incoming call. (Call Waiting service is required.)

EXIT: In **MENU** mode, allows

you to return to standby mode.

11 RD / P (Redial / Pause)

Press to redial last number dialed or insert pause (two seconds) when programming memories or pre-dialing.

12 Headset

A 2.5 mm headset can be used in the Headset Port. (We recommend the Plantronics M175C headset.)

13 TONE

Press to select the audio tone setting for the handset.

14 CALL BLOCK

Press to block incoming calls

15 RINGER ON / OFF

Switch to turn handset ringer on or off.

16 NECKLOOP

A 3.4B mm neckloop can be used in the Neckloop Port. (We recommend the Clarity CE30 Neckloop.)

17 Belt Clip**18 Speaker Grill****19 Battery Compartment**

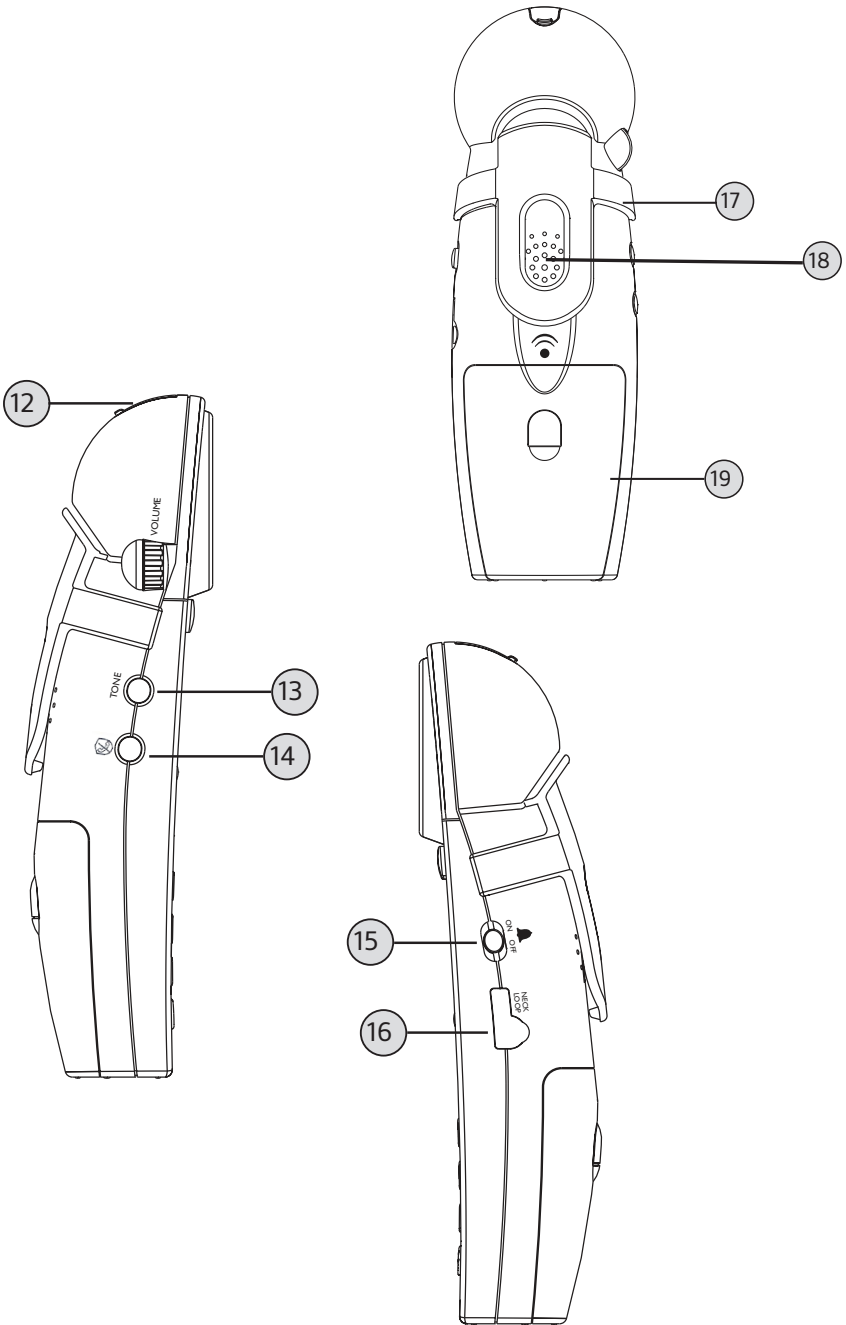

HANDSET

The batteries in the handset must be fully charged for 16 hours before using the telephone for the first time.

Battery life: Talk time is 6.5 hours, while standby is 130 hours without usage. Actual times will vary depending on the amplifier settings used. Replace batteries every two years.

Battery spec (as supplied with your phone): 3xAAA NiMH rechargeable batteries, (1.2V 600mAh NiMH - model 60AAAHc, GPI International Ltd. or KH-44AAA-J600, Yiyang Corun Battery Co., Ltd).

To replace batteries, remove the handset battery cover and install new batteries, then close battery cover.

BASE

The base backup batteries ensure the functionality of your cordless phone (3-4 hours) in case of a power outage.

When the base unit operates in battery mode (no AC power) the base POWER light will blink once every two seconds.

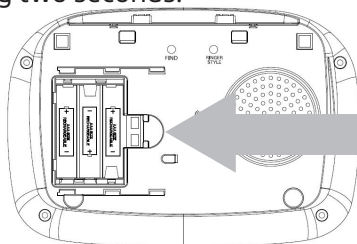

Open battery compartment door here.

To install batteries in the base:

1. Turn base over and open battery compartment door.
2. Install batteries according to the polarity shown inside the battery compartment.

NOTE: To replace handset batteries or to install base backup batteries, use ONLY standard rechargeable AAA NiMH batteries - 600mAh.

LOW BATTERY INFORMATION**Handset**

1. The battery icon on the screen shows no bars; the screen displays "Low Battery".
2. The handset beeps every two seconds in **OFF HOOK** mode.
3. The **TALK** button blinks green twice every 15 seconds in standby mode. It will not flash an alert in **OFF HOOK** mode.

Base (if optional batteries are installed)

1. The POWER light will blink green once every five seconds.

WARNING: Use rechargeable batteries only.

Do NOT use alkaline batteries!

To use a wireless enabled cell phone with your **XLC8**, you must first pair and connect your cell phone(s) with the telephone base. All **XLC8** and **XLC8HS** handsets can be used to make or answer calls on the cell line. Your cell line is the telephone line associated with your cell phone service.

Wireless enabled technology operates within a short range (a maximum of approximately 30 feet). When you pair a wireless enabled cell phone to the telephone base, place your wireless enabled cell phone closer to the telephone base to maintain sufficient signal strength. For optimal performance, keep your cell phone within 15 feet of the telephone base while using the cell line.

PAIR AND CONNECT YOUR WIRELESS ENABLED CELLPHONE

1. Choose a slot to pair the cell phone. Press and hold **PAIR 1** or **PAIR 2** on the telephone base until you hear a confirmation tone, and the **PAIR 1** or **PAIR 2** light flashes.
2. Turn on the pairing feature of your cell phone in the cell phone settings menu. Once your cell phone finds your Clarity phone (**Clarity XLC8**), press the appropriate key on your cell phone to continue the pairing process.
 - Your cell phone may prompt you to enter the PIN of the telephone base. The default PIN of the telephone base is **0000**.

When the cell phone is connected to the telephone base, the corresponding status icon (**PAIR 1** or **PAIR 2**) displays. The corresponding device light (**PAIR 1** or **PAIR 2**) turns on.

If the pairing fails, turn off the feature on your cell phone and on the **XLC8** by pressing **PAIR 1** or **PAIR 2**. Then repeat the steps above to pair and connect again. In some cases, it may take you a few attempts to complete the pairing process.

PAIR AND CONNECT YOUR WIRELESS-ENABLED HEADSET

1. Press **MENU** on the phone when it is not in use. Press **MENU** again to select **Mobile Devices**.
2. Press the **UP** or **DOWN** arrow keys to scroll to **Add Headset**, and then press **MENU**. The screen displays **Search headset....**
3. Set your headset to discoverable mode. Once your handset finds your headset, press **MENU** to select it.
 - Enter the PIN of your headset if required. The PIN for most wireless devices is 0000 (refer to the user's manual of your headset), and then press **MENU**.

When the headset is successfully paired and connected to the telephone base, the **PAIR 2** icon displays, and the **PAIR 2** light on the base turns on.

TO PLACE A CALL:

1. Press **TALK**, then dial the number using the numeric keypad. See lighting pattern for the **TALK** button on the bottom of the page.
2. Adjust the volume to the most comfortable level - using the Volume Control and **BOOST** button (if necessary).
3. Press the **TONE** button on the side of the handset to adjust the tonality of the incoming voice to the most comfortable level.

WARNING: VOLUME MAY BE LOUD!

NOTE:

1. If the **Voice Assist** function is enabled, you will hear the digits of the incoming phone number.
2. Step 1 above can be replaced with one of the following options:
 - Dial from CID records: Choose a record from your Caller List, then press **TALK**.
 - Dial from PHONEBOOK: Choose a record from your Phonebook, then press **TALK**.
 - Pre-dial: before pressing **TALK**, dial the number you wish to call; digits will display on the screen; press **TALK** when the number is complete.

NOTE: Pre-dial is not available if your default dial option is a mobile-enabled cellphone.

Follow with steps 2-3 above to enjoy a clear and comfortable phone conversation.

TO ANSWER A CALL:

1. When phone is ringing, press **TALK** to answer the call.
2. Adjust the volume and tone of the incoming voice according to your preferences.
3. When finished, press **TALK** to hang up.

NOTE:

1. For an explanation of the **TALK** button light, see the bottom of the page.
2. If you have CID service, note the incoming phone number displayed on your screen.
3. If the **Voice Assist** function is enabled, you will hear the digits of the incoming phone number.
4. At any point during the conversation, press the speakerphone button  to switch to handsfree mode. Use the volume control for adjusting the level of the incoming audio. Switch back to earpiece mode by pressing the speakerphone button again.

Talk Button Lighting Pattern

Green: Phone is in use.

Flashing Green every 15 seconds in standby mode: Low batteries.

The **BOOST** button engages the amplifier, controlling the loudness of the phone. When the **VOLUME** dial is adjusted and the **BOOST** button is pressed, the phone can reach up to 50dB of gain.

WARNING: VOLUME MAY BE LOUD. PROCEED WITH CARE.

BOOST On / Off

The **BOOST** button controls the loudness of the receiver. Once the **BOOST** button is pressed, an extra level of amplification is added over the entire range of volume control.

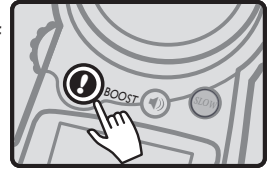

VOLUME Control Wheel

During a call, the dial on the side controls the level of volume for handset and speakerphone. The volume dial provides up to 16dB of volume before the **BOOST** button is activated. Once the **BOOST** button is pressed, the **XLC8** will provide up to 50dB of amplification.



Auto Boost

(For turning Auto Boost On or Off, see phone setup section.)

ON – When the Auto Boost is set to ON, the Boost function will be **ON** every time a call starts. If the phone hangs up, the Boost function will remain ON. Warning: the handset is at high volume when BOOST is on, which may damage user with normal hearing.

OFF – When the Auto Boost is set to OFF, the Boost function will be OFF at the beginning of all calls. Every time a call starts, the user will need to press the **BOOST** button in order to gain the extra level of amplification.

TONE

Press the **TONE** button to change the style of amplification. Switching audio tones will change how the telephone conversation sounds to you.

In order to achieve the best audio experience, we recommend the following:

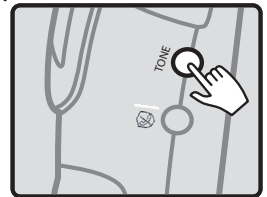

1. Adjust the Volume Control and enable the Boost function (if needed). (Lower the volume level to minimum (VOL 0) before activating the Boost feature.)
2. Press the **TONE** button to toggle between the available tone settings.

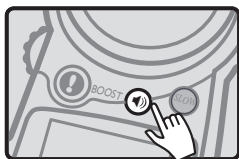
**Speakerphone**

To switch to speakerphone mode, press the **SPK** button . The display shows the speakerphone mode symbol.

Your **XLC8** is CID / CWCID compatible (optional service, purchased from your local telephone service provider).

When your phone is ringing, the screen shows the name and number of the person calling you. This information will be stored in the Caller List on your phone.

To access this list, and for further details regarding this function, press **UP** or **DOWN** in standby mode, and / or follow the instructions under **CALLER LIST**.

NOTE: If you have CID service, the date and time will automatically be set after the first incoming call.









The **SLOW** button allows you to slow down real time conversations. Press this button during a live call if you need to slow down the voice of the person you are talking to.

To access your phone's stored records (Phonebook), and for further details regarding this feature, press the **Phonebook** button  on the handset, and / or follow the instructions under the **PHONEBOOK** section.

IMPORTANT:

In standby mode, the screen displays the date and time, handset number (for the first 10 seconds of inactivity), and date and time (after the first 10 seconds of inactivity).

SCREEN ICONS AND SYMBOLS

-  Battery charge level. When the icon displays just one bar, return the handset to the charger.
-  New calls indicator. There are new calls in your Caller List.
-  The phone is in a call, in speakerphone mode.
-  The phone is in a call, in earpiece mode.
-  New voicemail (separate service).
-  Handset is connected to base, and in range.
-  ¹/₂ Wireless enabled devices are paired and in range.
-  Indicates home phone line is default dial out mode.
-  Indicates answering machine is turned on.

To start the setup process, press **MENU**. You will see the list of features to be set up on your new **XLC8**.

At any point during the navigation of the **MENU** options, you can press **MUTE / BACK** to go back to the previous screen, or you can press **FLASH / EXIT** to return to standby mode (exit setup).

To navigate through the menu options, press **UP** or **DOWN** arrows.

While in **MENU** mode, note the cursor on the top row, to the left of the text. It indicates that the feature displayed on the upper row is active. Press **MENU** to select that feature or option.

The **SETUP** menu allows you to choose your preferences for the following features of your new **XLC8**:

- **Mobile Devices** - to access cellphone/headset related settings;
- **1 Time Dial** - to change the default dial out mode;
- **Caller List** - to view and manage the information for your incoming calls - CID / CWCID service (required from your local telephone company);
- **Call Blocker** - to view and manage your call block modes, block list and announcement;
- **Phonebook** - to view and manage your saved records and VIP list (names and numbers for your frequently dialed locations);
- **Play messages**- to play new and old answering machine messages;
- **Answering System** - to change your announcement, delete messages, record memo, turn machine on and off and machine settings;
- **Intercom** - press to call additional handsets within the system;
- **Ringer Setup** - to choose ringer tones, set ringer volume, turn keypad tones on or off (default: On);
- **Visual Ring** - to turn your handset visual ringer on or off (default: On);
- **Auto Boost** - to enable Boost function to be active at the beginning of all calls (default: Off);
- **Phone Setup** - to re-establish registration to the base, to enable **Auto Talk** function (default: Off), to enable **Voice Assist** feature (default: On), to enable **Any Key Answer** (default: Off), to enable Outgoing Speech Amplification (default: Off), to choose the language you wish to use (default: English), to choose the dial mode needed for your specific setup (default: Tone), to adjust the contrast of your handset screen (default: medium);
- **Date & time** - to allow you to manually set the date and time; the date (month and day only) and time will be set during the first incoming call, if you subscribe to CID service from your local telephone service provider.

In standby mode, press **MENU**. Press **MENU** again to select **MOBILE DEVICES**. Here you will find menu settings for this feature.

Device List

In **MOBILE DEVICES** mode, press **MENU** to select “**Device List**”. You will see the WIRELESS-enabled devices paired to your **XLC8**.

Download PB

In **MOBILE DEVICES** mode, press **MENU** to select “**Download PB**”. Scroll to select the desired cellphone, then press **MENU**.

NOTE:

- For certain cell phones, you may need to press a key on your cell phone to confirm the phonebook downloaded.
- The performance of the phonebook download feature depends on the compatibility of your wireless enabled cell phone. Refer to the user's manual of your cell phone for more information about how that device uses wireless connectivity.

Add Headset

In **MOBILE DEVICES** mode, press **MENU** to select “**Add Headset**”. See **MOBILE DEVICES FUNCTIONS** section for complete instructions for this function.

Dial Default

If you have a mobile phone paired to the **XLC8** along with your home phone line, you can choose the mobile phone to be your default device when placing an outgoing call.

In **MOBILE DEVICES** mode, press **MENU** to select “**Dial Default**”. You will see list of options for this function. Home is your regular phone line (wall outlet).

Use **UP** or **DOWN** to choose your default dial mode. Press **MENU** to save your selection, or use **FLASH / EXIT** to return to the previous screen.

If you wish to use a different mode of dialing for the next outgoing call, before placing the call, use the “**1 Time Dial**” feature from the Menu options.

1 Time Dial

In standby mode, press **MENU**. Press **DOWN** to select “**1 Time Dial**”. You will see your list of additional options for dialing out. Select which one you wish to use, then press **MENU**. The next screen displays the different methods of dialing the number for the call: **Manual, Phonebook, Caller List, Redial**. Use **UP** or **DOWN** to make your selection, press **MENU**. Follow the prompts to place the call.

Review/Call from Caller List

If you have new calls, you will notice the **New Calls** icon  to the left of the battery level indicator (upper right corner).

In standby mode, press **MENU**. Scroll down to “**Caller List**”. Press **MENU** to select.

Your screen displays the number of new calls (which have not been reviewed yet). Scroll **UP** or **DOWN** to review the records in your call history (up to 40 records).

For each record, the screen alternates between showing the date / time of call and phone number, and the name associated with the phone number that called you.

Press **MUTE / BACK** to review the available formats for the record: 7 digits (no area code), 10 digits (area code + number), 11 digits (1+area code+number). The screen displays the new numbers.

When the format number is correct, press **TALK** if you wish to dial the number back.

Delete/Save/Delete All from Caller List

If you wish to save or delete the record from your memory, press **MENU** (after formatting the number). You will see the options available for that record. From here, choose one of the paths described below:

Del Number:

Select by pressing **MENU**. The screen displays “**Delete?**”. Press **MENU** to delete (screen displays **OK** and you hear five beeps), or **MUTE / BACK** to return to previous screen.

Save Number:

Select by pressing **MENU**. You can edit the number and then the name associated with the record. Press **MUTE / BACK** to delete the previous character; press **UP** or **DOWN** to move cursor within name. Use keypad to add characters to the name. Press **MENU** to save the record to your phonebook.

Delete All:

Select by pressing **MENU**. The screen displays “**Delete All?**”. Press **MENU** to delete all records (screen displays “**OK**” and you hear five beeps), or press **MUTE / BACK** to return to previous screen.

To access your call blocker functions from standby, press **MENU** once to enter the menu, then scroll down to select **CALL BLOCKER**. Press **MENU** again.

- The Call Blocker feature is only available to users who subscribe to Caller ID service.
- The phonebook/block list & VIP list are put on the base so that every handset shares the same database.
- User can assign any entries within the phonebook as VIP items. The VIP items inside phonebook will be shown with indication (*) at the end.
- 250 call block entries in maximum can be added in call block list, which are stored in base and shared within the whole system.
- The Call Blocker has no control over parallel phones. If the user picks up a parallel phone while a caller is being intercepted (or even when a caller is being played the Block message), they will be connected to the caller.

Call flows

Mode	VIP	PB contacts	Block list	All other callers
VIP mode	Allow	Send to AM	Block with BM	Screen with SM
Screen Other Callers	Allow	Allow	Block with BM	Screen with SM
Other Callers to AM	Allow	Allow	Block with BM	Send to AM
Off	Allow	Allow	Block with BM	Allow

NOTE: Answering Machine (AM), Block Message (BM), Screening Message (SM)

Call Blocker Voice Messages

- **Block message** "The number you are calling is not accepting your call. Please hang up."
- **Screening message** "Hello, calls to this number are being screened by Call Blocker, please say your name after the tone, then press pound."
- **Answering machine message** "Please leave a message after the tone."

Call Blocker and Remote Access

Key Press after screening

- **Press 1** Answer this call
- **Press 2** Answer this call and send this number to Phonebook (if there is a number)
- **Press 3** Send to the answering system
- **Press 4** Block and always block this number (if there is a number)
- **Press *(Star)** Repeat these options

MODES

- If "**VIP mode**" is selected, it will allow VIP contacts. It will send to answering machine for Phonebook contacts, and screen with screening message for all other callers. It will block with block message for the block list.
- If "**Screen Other Callers**" is selected, it will allow VIP contacts and Phonebook contacts, and screen all other calls with screening message. Callers will be asked to announce their name and press pound before putting through to you to decide if you wish to take the call. It will block with block message for the block list.
- If "**Other Callers to Ans. Mach.**" is selected, it will allow VIP contacts and Phonebook contacts, and send all other calls to answering machine without ringing handsets. It will block with block message for the block list.
- If Call Blocker feature is turned **off**, it will allow VIP contacts, Phonebook contacts and all other callers. It will block with block message for the block list.

BLOCK LIST

Press to view your block list or add numbers to your block list

Screening Announcement

Press to play your announcement, record your name and reset the screening announcement to default

To access your phonebook from standby, press **MENU** once to enter the menu, then scroll down to select **Phonebook**. Press **MENU** again. Use **UP** or **DOWN** to browse through your saved records.

Call from Phonebook

To dial one of your saved numbers, select the record and press **TALK**.

Add/Edit/Delete/Delete All from Phonebook - choose HOME or VIP LIST

To add a number, edit a number, delete a number or delete all numbers, press **MENU** while viewing a saved record. From here, choose one of the paths described below:

Add Number:

Select by pressing **MENU** to select "**Add Number**". You will be prompted to enter the number as you will dial it. To edit the number before saving it, use **MUTE / BACK** to delete the last digit (one at a time); use **UP** or **DOWN** to move within the number without deleting all digits. When finished, press **MENU** to save the number.

You will be prompted to enter the name for the number you saved. Use the numeric keypad to enter the name to be saved. When finished, press **MENU** to save the number.

Screen will display "**OK**" and you will hear five beeps.

Edit Number:

While viewing the record, press **DOWN** to advance the row that reads "**Edit Number**" to the top of the screen. Press **MENU** to select this option.

You will be prompted to edit the number - use **UP** or **DOWN** to move the cursor, or use **MUTE / BACK** to delete the last digit. Press **MENU** when the editing is complete.

You will be prompted to edit the name. Use the same controls as above.

Press **MENU** to save your edited record.

Screen will display "**OK**" and you will hear five beeps.

Del Number:

While viewing the record, scroll to "**Del Number**". Press **MENU** to select this option.

The screen displays "**Delete?**". Press **MENU** to delete (screen displays "**OK**" and you hear five beeps), or **MUTE / BACK** to return to previous screen.

Delete All:

While viewing the record, scroll to "**Delete All**". Press **MENU** to select this option.

The screen displays "**Delete All?**". Press **MENU** to delete (screen displays "**OK**" and you hear five beeps), or **MUTE / BACK** to return to previous screen.

XLC8

MENU - PLAY MESSAGES

In standby mode, press **MENU**.

Press **UP** or **DOWN** to play new and old answering machine messages

XLC8

MENU - ANSWERING SYSTEM

In standby mode, press **MENU**.

Press **UP** or **DOWN** to advance the row that reads "ANS. SYS.". Press **MENU** to enter the **ANSWERING SYSTEM Setup** sub menu.

- **The ANSWERING SYSTEM Setup sub menu allows you to adjust the following features:**
- **Announcement - (Record Announcement, Play Announcement, Reset Announcement)**
- **Delete all old - (Delete all old messages)**
- **Record Memo - (Record memo after the tone)**
- **Answer on/off - (Answering machine On / Off)**
- **Answer system setup**
 - Screening (On/Off)
 - # of rings (Toll Saver, 2, 3, 4, 5, 6)
 - Remote Code (set for checking messages remotely)
 - Message Alert Tone (On/Off)
 - Recording Time (1, 2, 3 minutes)

XLC8

MENU - INTERCOM

In standby mode, press **MENU**.

Press **UP** or **DOWN** to **INTERCOM** to choose which paired handset, or **all**, you wish to call within the house.

In standby mode, press **MENU**, then scroll to select "**Ring Setup**"; press **MENU** to enter the ringer setup. You will see the available options for your ringer.

From here, choose one of the paths described below - for both the home and the cellphone lines:

Ringer Vol:

In order to adjust the ringer volume, the **RINGER ON / OFF** switch on the side of the **XLC8** handset must be set to the **ON** position. Use **UP** or **DOWN** to reach the desired level of ring loudness. When finished, press **MENU** to save your setting.

Screen will display "**OK**" and you will hear five beeps.

If the **RINGER ON / OFF** switch is set to OFF, the screen displays "Ringer Off" (middle of screen) with no sound made. Turn ringer volume switch **ON** or return phone to standby.

Ringer Tone:

To adjust the ringer tone, press **DOWN** to advance the row that reads "Ringer Tone" to the top of the screen. Press **MENU** to select this option. Use **UP** or **DOWN** to scroll through the available ring tones.

Press **MENU** to save the setting you selected. Screen will display "**OK**" and you will hear five beeps.

Keypad Tone:

To turn the keypad tones high, low or off, press **DOWN** twice to advance the row that reads "Keypad Tone" to the top of the screen. Press **MENU** to select this option.

Use **UP** or **DOWN** to make your selection. Press **MENU** to save. Screen will display "**OK**" and you will hear five beeps.

In standby mode, press **MENU**.

Press **UP** or **DOWN** to advance the row that reads "**Visual Ring**".

Press **MENU** to enter the handset visual ringer On / Off setup.

Use **UP** or **DOWN** to make your selection. Press **MENU** to save your selection. Screen will display "**OK**" and you will hear five beeps.

NOTE: This option refers to the handset visual ringer only.

In standby mode, press **MENU**.

Press **UP** or **DOWN** to advance the row that reads "Auto Boost". Press **MENU** to enter the Auto Boost On / Off setup.

Use **UP** or **DOWN** to make your selection. Press **MENU** to save your selection. Screen will display "**OK**" and you will hear five beeps.

In standby mode, press **MENU**.

Press **UP** or **DOWN** to advance the row that reads "**Phone Setup**". Press **MENU** to enter the **Phone Setup** submenu.

The **Phone Setup** submenu allows you to adjust the following features:

- **Register**
- **Auto Talk** (On / Off, default: Off)
- **Voice Assist (Voice Asst:** On / Off; default: On) - English/
French
- **Any Key Answer** (On / Off; default: Off)
- **OSA (On/Off; default: Off)**
- **Language** (English/French/Spanish, default: English)
- **Dial Mode** (Tone / Pulse, default: Tone)

Register

• **Contrast** (1-5, default: 3)
Press **MENU** to access this function. See handset registration section.

Auto Talk

Press **UP** or **DOWN** once to advance the row reading "**Auto Talk**". Press **MENU** to enter this option.

Use **UP** or **DOWN** to make your selection. Press **MENU** to save your selection. Screen will display "**OK**" and you will hear five beeps.

Voice Assist

This option activates the audio numbers - both for the phone numbers dialed, as well as the incoming phone numbers (with optional CID service from your local phone service provider.)

Press **UP** or **DOWN** to advance the row reading "**Voice Asst**". Press **MENU** to enter this option.

Use **UP** or **DOWN** to make your selection. Press **MENU** to save your

selection. The screen will display **"OK"** and you will hear five beeps.

Any Key Answer

This feature allows you to answer the call by pressing any numeric key on the handset, rather than pressing **TALK** and Speakerphone.

Press **UP** or **DOWN** to advance the row reading "Any Key Ans". Press **MENU** to enter this option.

Use **UP** or **DOWN** to make your selection. Press **MENU** to save your selection. The screen will display **"OK"** and you will hear five beeps.

OSA (Outgoing Speech Amplification)

This feature allows you to make your voice louder during a call.

WARNING: Voice volume level may be loud. We recommend that you turn on the OSA function ONLY if your voice is considered too quiet.

Press **UP** or **DOWN** to advance the row reading "OSA". Press **MENU** to enter this option.

Use **UP** or **DOWN** to make your selection. Press **MENU** to save your selection. The screen will display **"OK"** and you will hear five beeps.

Language

Press **UP** or **DOWN** to advance the row reading "Language". Press **MENU** to enter this option.

Use **UP** or **DOWN** to make your selection. Press **MENU** to save your selection. The screen will display **"OK"** and you will hear five beeps.

Dial Mode (Tone/Pulse)

Press **UP** or **DOWN** to advance the row reading "Dial Mode". Press **MENU** to enter this option.

Use **UP** or **DOWN** to make your selection. Press **MENU** to save your selection. The screen will display **"OK"** and you will hear five beeps.

Contrast

Press **UP** or **DOWN** to advance the row reading "Contrast". Press **MENU** to enter this option.

Use **UP** or **DOWN** to make your selection. There are five levels available (default: Level 3). Press **MENU** to save your selection. The screen will display **"OK"** and you will hear five beeps.

In standby mode, press **MENU**. Press **UP** or **DOWN** arrow to advance the row that reads "Date & Time". Press **MENU** to enter the date and time setup.

Use the numeric keypad to enter the date (follow format on screen). Press **MENU** to save your selection. Use the numeric keypad to enter the time (follow format on screen).

Press **MENU** to save your selection. The screen will display "**OK**" and you will hear five beeps.

Registering the XLC8HS

In order to use the **XLC8HS** handset (sold separately), you must register it to the **XLC8** base.

Pull the handset's battery tab located on the bottom of the device, and then press **MENU** to start registering or deregistering your handset from your system.

To register an unregistered handset

1. Press **MENU** to enter registration mode. You will see displayed on the screen, "Handset Needs Registration."
2. Press and hold the **FIND** key on the **XLC8** base for five seconds, until the base visual ringer starts flashing. Release **FIND** key on the **XLC8** base.
3. Press **MENU** key on the handset.
4. The screen shows "**Registering...**", then "Registration Successful" (accompanied by five quick beeps).
5. Your handset is now registered to your **XLC8** system. Your screen will display "Handset X," (where "X" is the number of the actual handset registered, such as the second or fourth handset, etc.).

TO REGISTER YOUR HANDSET AGAIN (or to register to a different XLC8 system)

1. In standby mode, press **MENU**.
2. Press **UP** or **DOWN** to advance the row reading "**Phone Setup**". Press **MENU** to enter the setup section. The screen displays "**Register**" on the screen's top row now.
3. Press **MENU** to enter the Registration section.
4. Press **MENU** again to select "**Register**."
5. Follow the Registration steps listed above.

To deregister the handset

1. See the five steps listed above, then press **MENU** to select "Deregister."
2. **Your handset will deregister from your base as soon as you press MENU.** The screen will show "Handset X Deregistered"(again, where "X" is the number of the handset registered), then "Handset Needs Registration."

I cannot add and connect my cell phone or headset to the telephone base.

- Make sure you have cellular coverage and the wireless pairing function of your cell phone or headset is turned on. See the user's manual of your cell phone or headset for more information.
- Make sure that the telephone base is in discoverable mode.
- Carefully follow the pairing instructions. Make sure that your wireless enabled cell phone or headset is not connected to any other wireless enabled device, and is connected to the telephone base and active on the device list.
- Remove Clarity **XLC8** from your cell phone's hands free device history list (see the user's manual of your cell phone for more information).
- Turn off your cell phone or headset, and then turn it on again.
- For some cell phones, you must authorize Clarity **XLC8** device in your cell phone's wireless pairing feature. See the user's manual of your cell phone for more information.
- Most cell phones have the wireless pairing feature in the connection or setup menus. Please refer and then look for the wireless pairing menu in the settings or connection menu. In the wireless pairing menu, select the option to search for or add new devices.
- Reset the telephone base. Unplug the unit's electrical power. Wait for approximately 15 seconds, and then plug it back in. Repeat the above suggestions.

The PIN on the telephone base does not work.

- Make sure you enter the correct PIN. The default PIN is 0000.

Can the XLC8 help the poor cell phone reception in my house?

- If your cell phone has poor reception in your home, the **XLC8** cannot improve the reception. However, if there is a location in your house with better reception, you can leave your cell phone at that location while you use the **XLC8** cell line. In order for this to work, the telephone base must be within 30 feet of the cell phone.

The unit will not operate / no dial tone:

- Verify the AC adapter is securely plugged into the AC outlet, the base and the telephone.
- Verify the telephone line cord is securely plugged into the wall jack and the telephone.
- Make sure the handset battery is fully charged.
- Make sure the battery has been placed in the battery compartment

correctly. (The circular metal contacts on battery need to touch the metal springs inside battery compartment.)

- Verify the telephone is in the correct dialing mode: Tone (touch) or Pulse (rotary).
- Make sure you are in the usable range of the base station.

The phone does not ring when you receive a call:

- Make sure the RINGER switch on both handset and base is set to ON.
- Verify the AC adapter is securely plugged into the AC outlet, the base and the telephone.
- Verify the telephone line cord is securely plugged into the wall jack and the telephone.
- Make sure you are within the usable range of the base station.
- You may have too many extensions on your line. Try unplugging a few devices.

Noise, interference or other calls heard while using the handset:

- Make sure you are within the usable range of the base station.
- Make sure the handset battery is fully charged.
- Try relocating the base unit to another location.
- Make sure the AC adapter is not plugged into the wall outlet with other appliances.

Phone will not hold charge:

- Make sure the charging contacts on the handset and base are free of dust and dirt. While unplugged, clean the contacts with a soft cloth.
- Make sure IN USE / CHARGE light on the base is lit when the handset is in the cradle.
- If necessary, replace the handset battery.

Difficulty in placing or receiving calls:

- Move closer to the base and try again.
- Make sure you have selected the correct dialing mode, tone or pulse.
- Make sure the AC adapter is not plugged into a wall outlet with other appliances. Disconnect for 5-10 seconds then reconnect. Place the handset back on the base and reinsert the AC adapter.
- Make sure the handset battery is fully charged.

Your handset screen is displaying “Searching...”:

- Verify that the AC adapter is plugged into the base and into the wall outlet.
- The handset is out of range or the power to the base is unplugged.
- Move closer to the base.
- Place the handset into the base until the screen returns to standby mode. It will take approximately 5-10 seconds for the handset to register to the base.
- Handset may need to be re-registered to the base manually. Follow instructions on page 27.

Screen displays “Battery Low”:

- Handset batteries are low on charge; return the handset to the base to recharge the batteries.

TALK button is blinking green (fast pace):

- The base is trying to locate the handset; press **TALK** to end the FIND paging process and return the handset to the base.

Base POWER light blinks green once every second:

- The power adapter may not be plugged in. Verify AC adapter is plugged into proper wall outlet.

Base POWER light blinks green every five seconds:

- The power adapter may not be plugged in. Verify AC adapter is plugged into proper wall outlet.
- The base batteries may be “low” (their charge). If necessary, replace batteries.

General

Frequency: 1.9GHz DECT6.0

Amplification: 50dB

Power Supply

AC Adapter: Input: 100V-240V AC

Output: 6VDC, 800 mA

Additional Handsets

Clarity part number: XLC8HS, XLCgo

The **XLC8** will support a maximum of four (4) handsets registered to a base, and two (2) handsets maximum used in the same call.

(Additional Handsets sold separately.)

Battery information

Battery Type: 1.2V NiMH 600mAh rechargeable batteries

Battery Life Talk Time: 6.5 Hours

Battery Life standby: 130 Hours

PARTY RESPONSIBLE FOR REGULATORY COMPLIANCE:

Clarity Products LLC
6131 Preservation Drive
Chattanooga, TN 37416
Phone: 800-426-3738

Part 68 of FCC Rules Information

- a) This equipment complies with Part 68 of the FCC rules and the requirements adopted by the ACTA. On the bottom of this equipment is a label that contains, among other information, a product identifier in the format US:AAAEQ##TXXXX. If requested, this number must be provided to the telephone company.
- b) A plug and jack used to connect this equipment to the premise's wiring and telephone network must comply with the applicable FCC Part 68 rules and requirements adopted by the ACTA. A compliant telephone cord and modular plug, RJ11C USOC, is provided with this product. It is designed to be connected to a compatible modular jack that is also compliant. See installation instructions for details.
- c) The REN is used to determine the number of devices that may be connected to a telephone line. Excessive RENs on a telephone line may result in the devices not ringing in response to an incoming call. In most but not all areas, the sum of RENs should not exceed five (5.0). To be certain of the number of devices that may be connected to a line, as determined by the total RENs, contact the local telephone company. For products approved after July 23, 2001, the REN for this product is part of the product identifier that has the format US:AAAEQ##TXXXX. The digits represented by ## are the REN without a decimal point (e.g., 03 is a REN of 0.3).
For earlier products, the REN is separately shown on the label.
- d) If this telephone equipment causes harm to the telephone network, the telephone company will notify you in advance that temporary discontinuance of service may be required. But if advance notice isn't practical, the telephone company will notify the customer as soon as possible. Also, you will be advised of your right to file a complaint with the FCC if you believe it is necessary.
- e) The telephone company may make changes in its facilities, equipment, operations or procedures that could affect the operation of the equipment. If this happens the telephone company will provide advance notice in order for you to make necessary modifications to maintain uninterrupted service.
- f) If trouble is experienced with this telephone equipment, for repair or warranty information, please contact Clarity, 800-426-3738. If the equipment is causing harm to the telephone network, the telephone company may request that you disconnect the equipment until the problem is resolved.
- g) This telephone equipment is not intended to be repaired and it contains no repairable parts. Opening the equipment or any attempt to perform repairs will void the warranty. For service call 800-426-3738.

h) Connection to party line service is subject to state tariffs. Contact the state public utility commission, public service commission or corporation commission for information.

i) If your home has specially wired alarm equipment connected to the telephone line, ensure the installation of this telephone equipment does not disable your alarm equipment. If you have questions about what will disable alarm equipment, consult your telephone company or a qualified installer.

j) This telephone equipment is hearing aid compatible.

Customer-Owned Coin/Credit Card Phones

To comply with state tariffs, the telephone company must be given notification prior to connection. In some states, the state public utility commission, public service commission or corporation commission must give prior approval of connection.

Part 15 of FCC Rules Information

This device complies with Part 15 of the FCC Rules. Operation is subject to the following two conditions: (1) This device may not cause harmful interference, and (2) this device must accept any interference received, including interference that may cause undesired operation.

Your equipment has been tested and found to comply with the limits of a Class B digital device, pursuant to Part 15 of FCC rules. These limits are designed to provide reasonable protection against harmful interference in residential installation.

This equipment generates, uses and can radiate radio frequency energy and, if not installed and used in accordance with the instructions, may cause harmful interference to radio communications. However, there is no guarantee that interference will not occur in a particular installation; if this equipment does cause harmful interference to radio or television reception, which can be determined by turning the equipment off and on, you are encouraged to try to correct the interference by one of the following measures:

1. Where it can be done safely, reorient the receiving television or radio antenna.
2. To the extent possible, relocate the television, radio or other receiver with respect to the telephone equipment. (This increases the separation between the telephone equipment and the receiver.)
3. Connect the telephone equipment into an outlet on a circuit different from that to which the television, radio or other receiver is connected.
4. Consult the dealer or an experienced Radio/TV Technician for help.

Privacy of communications may not be ensured when using this phone.

WARNING: To maintain the compliance with the FCC's RF exposure guideline, place the base unit at least 20 cm from nearby persons.

For body worn operation, this handset has been tested and meets the FCC RF exposure guidelines when used with the Clarity accessories supplied or designated for this product. Use of other accessories may not ensure compliance with FCC RF exposure guidelines.

WARNING: Changes or modifications to this equipment not expressly approved by the party responsible for compliance could void the user's authority to operate the equipment.

Industry Canada Technical Specifications

This device contains license-exempt transmitter(s)/receiver(s) that comply with Innovation, Science and Economic Development Canada's license-exempt RSS(s). Operation is subject to the following two conditions: (1) This device may not cause interference, and (2) this device must accept any interference, including interference that may cause undesired operation of the device.

This product meets the applicable Innovation, Science and Economic Development Canada technical specifications.

Privacy of communications may not be ensured when using this phone.

Before installing this equipment, users should ensure that it is permissible to be connected to the facilities of the local telecommunications company. The equipment must also be installed using an acceptable method of connection. In some cases, the company's inside wiring associated with a single line individual service may be extended by means of a certified connector assembly (telephone extension cord). The customer should be aware that compliance with the above conditions may not prevent degradation of service in some situations. Repairs to certified equipment should be made by an authorized Canadian maintenance facility designated by the supplier.

Any repairs or alterations made by the user to this equipment, or equipment malfunctions, may give the telecommunications company cause to request the user to disconnect the equipment.

Users should ensure for their own protection that the electrical ground connections of the power utility, telephone lines and internal metallic water pipe system, if present, are connected together. This precaution may be particularly important in rural areas.

WARNING: Users should not attempt to make such connections themselves, but should contact the appropriate electrical inspection authority, or electrician, as appropriate.

The Ringer Equivalence Number is an indication of the maximum number of terminals allowed to be connected to a telephone interface. The termination on an interface may consist of any combination of devices subject only to the requirement that the sum of the Ringer Equivalence Numbers of all the devices does not exceed five.

This Class B digital apparatus complies with Canadian ICES-003.

(The term "IC:" before the certification/registration number only signifies that the Industry Canada technical specifications were met.)

Incidental or Consequential Damages: Neither Clarity nor your retailer dealer or selling distributors have any responsibility for any incidental or consequential damages including without limitation, commercial loss of profit, or for any incidental expenses, expenses, loss of time, or inconvenience. Some states do not allow exclusion or limitation of incidental or consequential damage, so the above limitation or exclusion may not apply to you.

Other Legal Rights: This warranty gives you specific legal rights and you may also have other rights which vary from state to state.

To obtain warranty service, please prepay shipment and return the unit to the appropriate facility listed below.

Please use the original container, or pack the unit(s) in a sturdy carton with sufficient packing material to prevent damage. Include the following information:

- A proof-of-purchase indicating model number and date of purchase;
- Bill-to address;
- Ship-to address;
- Number and description of units shipped;
- Name and telephone number of person to call, should contact be necessary;
- Reason for return and description of the problem.

Damage occurring during shipment is deemed the responsibility of the carrier, and claims should be made directly with the carrier.

The following warranty and service information applies only to products purchased and used in the U.S. and Canada. For warranty information in other countries, please contact your local retailer or distributor.

Limited Warranty: Clarity Products LLC (“Clarity”) warrants to the original consumer purchaser that, except for limitations and exclusions set forth below, this product shall be free from defects in materials and workmanship for a period of one (1) year from the date of original purchase (“Warranty Period”). The obligation of Clarity under this warranty shall be at Clarity’s option, without charge, of any part or unit that proves to be defective in material or workmanship during the Warranty Period.

Exclusions from Warranty: This warranty applies only to defects in factory materials and factory workmanship. Any condition caused by accident, abuse, misuse or improper operation, violation of instructions furnished by Clarity, destruction or alteration, improper electrical voltages or currents, or repair or maintenance attempted by anyone other than Clarity or an authorized service center, is not a defect covered by this warranty. Telephone companies manufacture different types of equipment and Clarity does not warrant that its equipment is compatible with the equipment of a particular phone company.

Implied Warranties: Under state law, you may be entitled to the benefit of certain implied warranties. These implied warranties will continue in force only during the warranty period. Some states do allow limitations on how long an implied warranty lasts, so the above limitation may not apply to you.