

User Guide

clarity®

E  
N  
G  
L  
I  
S  
H

# XLC3.4™+

**Extra Loud Cordless  
Speakerphone with Caller ID**

F  
R  
A  
N  
Ç  
A  
I  
S



E  
S  
P  
A  
Ñ  
O  
L



## **XLC3.4+ TABLE OF CONTENTS**

IMPORTANT SAFETY INSTRUCTIONS	2
CONTENTS & PARTS CHECKLIST	5
INSTALLATION	6
WALL MOUNTING YOUR XLC3.4+	8
BASE - Quick Reference Guide	10
HANDSET - Quick Reference Guide	11
BATTERY INFORMATION	14
PLACING & ANSWERING CALLS	15
VOLUME & TONE ADJUSTMENTS	16
CALLER ID FUNCTION	17
PHONEBOOK	18
SCREEN DETAILS	18
TELEPHONE MENU	19
HANDSET REGISTRATION	28
TROUBLESHOOTING	29
TECHNICAL SPECIFICATIONS	32
REGULATORY COMPLIANCE	33
WARRANTY INFORMATION	36

## **XLC3.4+ IMPORTANT SAFETY INSTRUCTIONS**

When using your telephone equipment, basic safety precautions should always be followed to reduce the risk of fire, electric shock and injury to persons, including the following:

1. Read and understand all instructions.
  2. Follow all warnings and instructions marked on the telephone.
  3. Avoid contact with liquids. Do not locate base unit or handset near water, for example, near a bathtub, wash basin, sink or laundry tub, in a wet basement or near a swimming pool.
  4. Avoid using a telephone (other than a cordless type) during a storm. There may be a remote risk of electrical shock from lightning.
  5. Do not use the telephone to report a gas leak in the vicinity of the leak.
  6. Unplug this telephone from the wall outlets before cleaning. Do not use liquid cleaners or aerosol cleaners on the telephone. Use a damp cloth for cleaning.
  7. Place this telephone on a stable surface. Serious damage and/or injury may result if the telephone falls.
  8. Do not cover the slots and openings on this telephone.
- This telephone should never be placed near or over a radiator or heat register. This telephone should not be placed in a built-in installation unless proper ventilation is provided.
9. Operate this telephone using the electrical voltage as stated on the base unit or the owner's manual. If you are not sure of the voltage in your home, consult your dealer or local power company.
  10. Do not allow anything to rest on the power cord or locate this product in an area where the power cord is likely to be damaged by furniture or foot traffic.
  11. Do not overload wall outlets or extension cords as this can increase the risk of fire or electrical shock.
  12. Never push any objects through the slots in the telephone. They can touch dangerous voltage points or short out parts that could result in a risk of fire or electrical shock. Never spill liquid of any kind on the telephone.
  13. To reduce the risk of electrical shock, do not take this phone apart. Opening or removing covers may expose you to dangerous voltages or other risks. Incorrect reassembly can cause electric shock when the appliance is subsequently used.

**SAVE THESE INSTRUCTIONS**

## **XLC3.4+ IMPORTANT SAFETY INSTRUCTIONS**

14. Unplug this product from the wall outlet and refer servicing to the manufacturer under the following conditions: when the power supply cord or plug is frayed or damaged; if liquid has been spilled into the product; if the telephone has been exposed to rain or water; if the telephone has been dropped or the case has been damaged; if the telephone exhibits a distinct change in performance; if the telephone does not operate normally by following the operating instructions. Adjust only those controls that are covered by the operating instructions. Improper adjustment may require extensive work by a qualified technician to restore the telephone to normal operation if the telephone does not operate normally by following the operating instructions.
15. This product should be operated only from the type of power source indicated on the marking label. If you are not sure of the type of power supply to your home, consult your local power company.
16. Do not attempt to open the AC adapter. There are potentially dangerous voltages inside, and there are no serviceable parts.
17. Discontinue use of product and contact Clarity if the product overheats, has a damaged cord or plug, if the product has been dropped or damaged or if the product has come into contact with liquids.
18. Use only the AC adapter provided with this product or a replacement AC adapter provided by Clarity.
19. This phone amplifies sound to loud volumes. To prevent hearing damage, all users of the phone should be informed of the high volume capability of the phone and children should only use the phone when supervised by an adult.
20. Exposure to high volume sound levels or excessive sound pressure may cause temporary or permanent damage to your hearing. Although there is no single volume setting that is appropriate for everyone, you should always use your telephone with the volume set at moderate levels and avoid prolonged exposure to high volume sound levels. The louder the volume, the less time is required before your hearing could be affected. If you experience hearing discomfort, you should have your hearing checked by a doctor. To protect your hearing, you should:
  - A) Set the volume control

**SAVE THESE INSTRUCTIONS**

## **XLC3.4+ IMPORTANT SAFETY INSTRUCTIONS**

in a low position and gradually increase the volume as needed.

Before pressing the **BOOST**

button, reduce the volume to the lowest level. Use the phone on the lowest volume setting as possible.

B) Limit the amount of time you use the telephone at high volume levels.

21. If you experience a skin irritation after using this product, discontinue use and contact Clarity.

### **BATTERY SAFETY INSTRUCTIONS**

**Dispose of used batteries according to the instructions.**

1. Do not dispose of the battery in a fire as it may explode. Check with local codes for possible special disposal instructions.
2. Do not open or mutilate the battery. Released electrolyte is corrosive and may cause damage to the eyes and skin. It may be toxic if swallowed.
3. Exercise care in handling batteries in order not to short the battery with conducting materials such

as rings, bracelets and keys. The battery or conduction material may overheat and cause burns.

4. Remove batteries when they are discharged and when the equipment will not be used for an extended period of time. Dispose of batteries according to local environmental laws.
5. Do not disassemble, heat, crush, deform or puncture batteries.
6. Do not attempt to charge non-rechargeable batteries.
7. Keep batteries out of the reach of children.

**WARNING:** Risk of explosion if battery is replaced by an incorrect type.

**SAVE THESE INSTRUCTIONS**

# XLC3.4+ CONTENTS & PARTS CHECKLIST

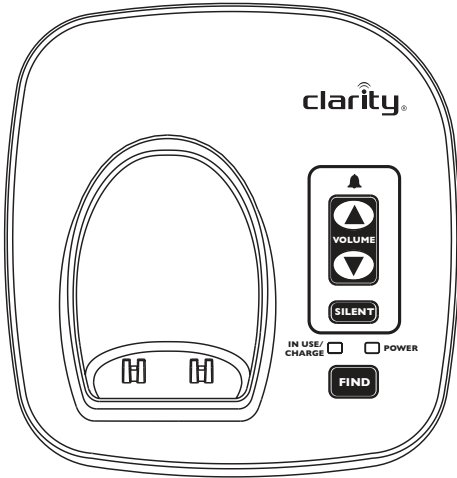

Base



Handset

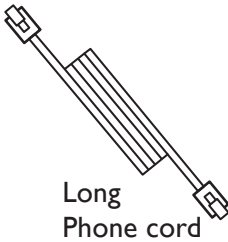

Long  
Phone cord

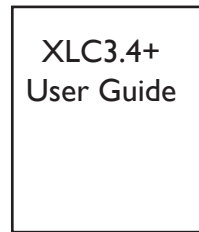

User  
guide



AC power adapter

## **XLC3.4+ INSTALLATION**

Connect your telephone as shown on the enclosed Quick Start guide.

Your telephone should arrive pre-assembled. To install it:

1. Remove base from package; pull yellow tab in the direction of the arrow.
2. Hold one end of your XLC3.4+'s long phone line cord tightly. The correct end to hold should already be plugged into your phone's jack. Simultaneously pull the other end of the phone cord away from the phone, unraveling it and allowing you to plug that end of the cord into a wall telephone outlet.
3. Plug the loose end of the phone cord into the wall telephone outlet.
4. Hold one end of your phone's white power adapter cord tightly. The correct end to hold should already be plugged into the back of your telephone base unit. Simultaneously pull the other end of the adapter cord away from the phone, unraveling it and allowing you to plug that end of the cord into a wall electrical outlet.
5. Plug white power adapter cord on left rear of the base into a wall electrical outlet.
6. Remove handset from package.
7. Pull the handset's battery tab located on the bottom of the device in the direction of the arrow.
8. Place the handset in the base charger. The batteries in the handset must be fully charged for 16 hours before using the telephone for the first time.
9. Lift handset and press **TALK** to test. If you hear a dial tone, your telephone is ready for use. If not, check all connections again.



# XLC3.4+ INSTALLATION

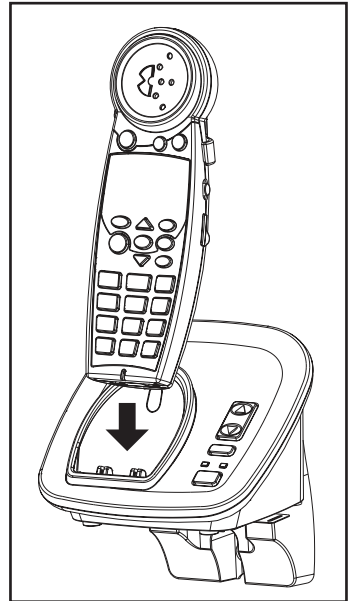
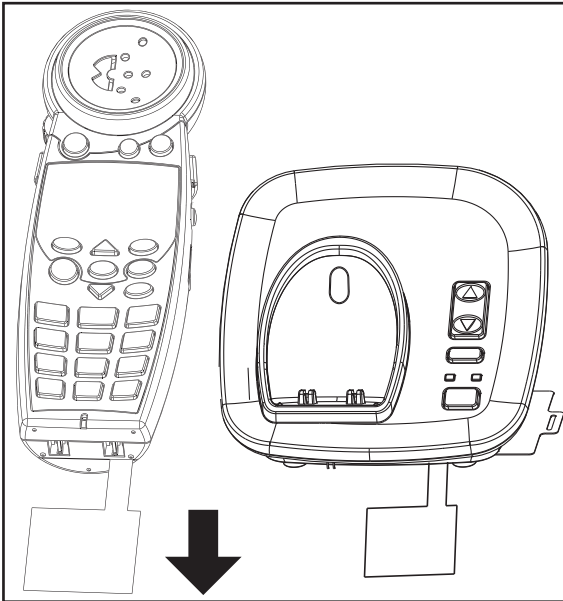
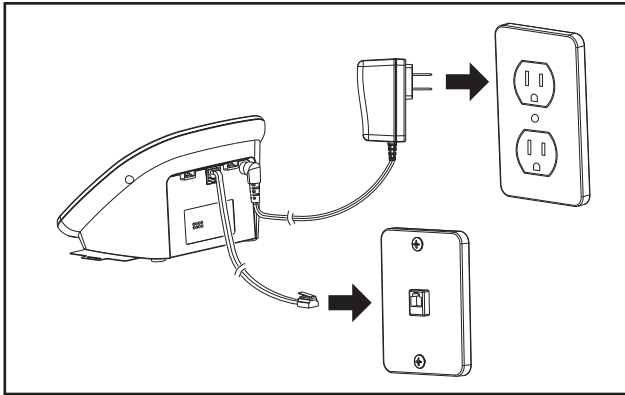
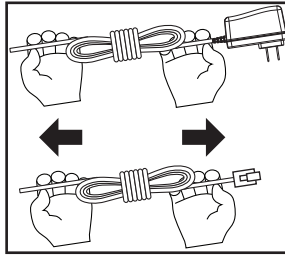

## **XLC3.4+ WALL MOUNTING YOUR XLC3.4+**

\*Wall mount available upon request.

- 1. Follow the instructions in the Installation section on page 6 to remove the base and handset from the base – steps 1, 4, 6.**
- 2. Unplug the long phone line cord from the phone jack located on the back of your XLC3.4+. Plug one end of the short phone line cord into the same jack identified by LINE on the back of your base.**
- 3. Install the XLC3.4+ base onto the wall mount bracket as shown on page 9. Guide the short phone cord through the wall mount bracket as shown in the diagram.**
- 4. Using a screwdriver, loosen the screws on your phone wall outlet (1-2 turns).**
- 5. Plug the loose end of the short phone cord into the wall phone outlet.**
- 6. Attach the wall mount bracket (with the XLC3.4+ base) onto the wall phone outlet.**
- 7. Plug the power adapter into a wall electrical outlet.**
- 8. Pull the handset's battery tab located on the bottom of the device in the direction of the arrow.**
- 9. Place the handset in the base and allow 16 hours for full charge.**

# XLC3.4+ WALL MOUNTING YOUR XLC3.4+

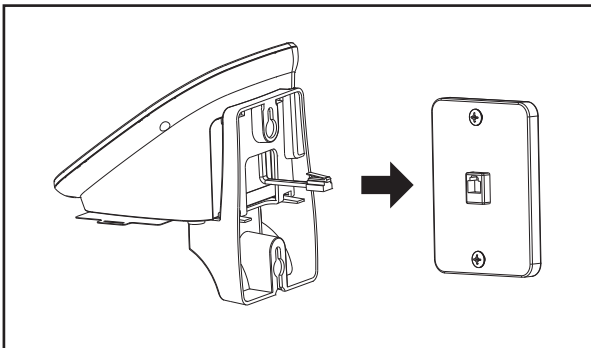
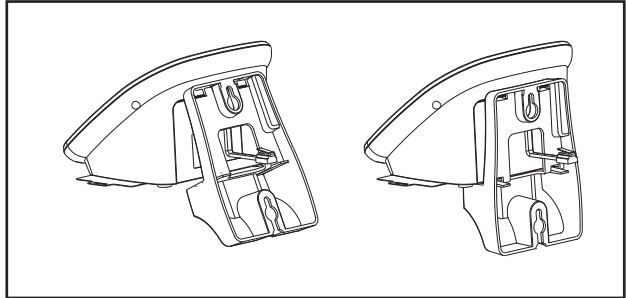
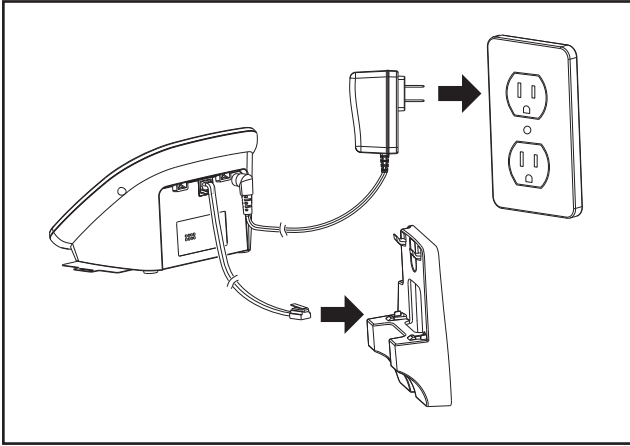

# XLC3.4+ BASE - Quick Reference Guide

## 1 Visual Ringer

Lights up when phone rings;  
turns on when phone is in use.

## 2 IN USE / CHARGE Light

The light turns red when the phone is charging, and it turns green when the phone is in use.

## 3 POWER Light

Light is lit green when the power adapter is plugged in.

During a power outage, the POWER light will blink green once every two seconds when base backup batteries are installed.

## 4 FIND

Press this key to locate handset.

## 5 SILENT

Press if you want to turn off the base ringer. The button lights up red when the ringer is turned off.

## 6 VOLUME (UP / DOWN)

Use these keys to increase or decrease the ringer volume.

## 7 RINGER STYLE

Use this key to choose the most comfortable base ring tone for your environment. There are six ring tones available.

**NOTE (Base):** You can only set the ringer volume or style when the phone is not in use.

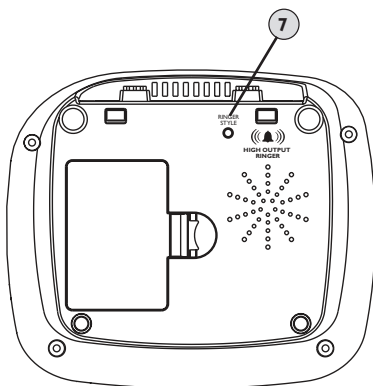
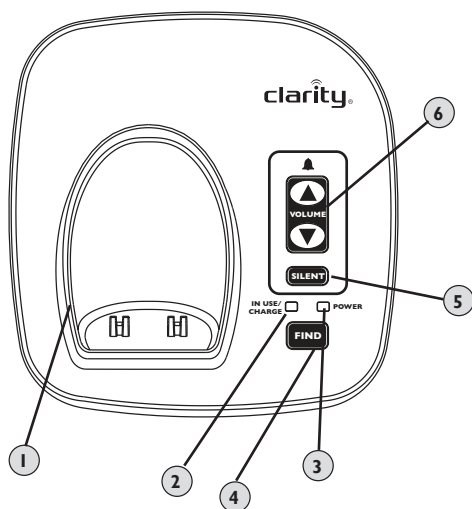

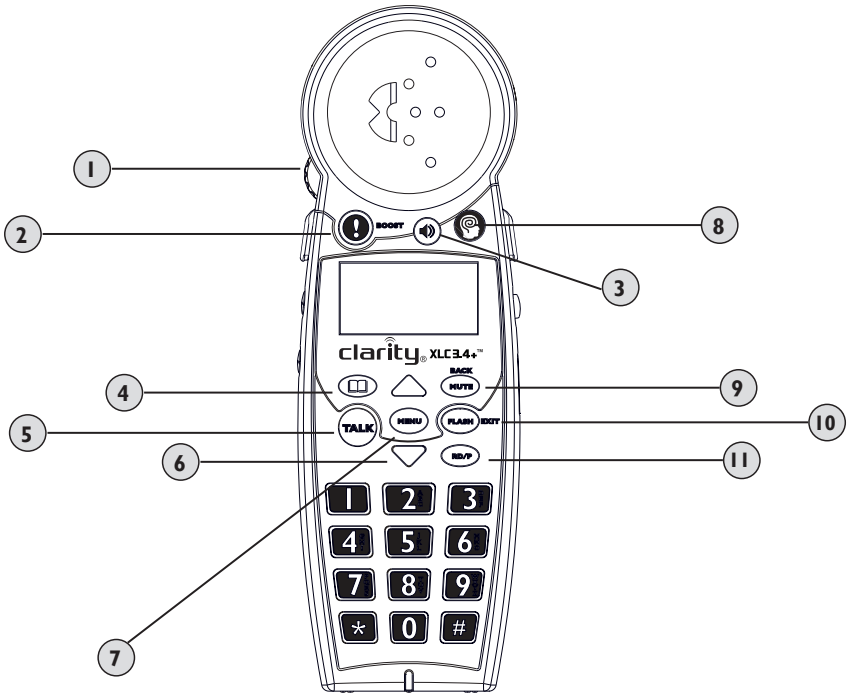

## 1 **VOLUME Control Wheel**

Use the rotary control to increase or decrease the volume of the incoming call. The volume level is displayed on the screen, lower right corner.

## 2 **BOOST**

Press this button to engage the extra amplification. The BOOST button turns red when Boost function is active.

For more details on the Boost function, see page 16.

## 3 **Speaker**

During a call, press to activate handset speakerphone. Press again to switch back to earpiece.

When in speakerphone mode, the speakerphone icon is displayed on the screen (to the left of the battery icon), and the speakerphone button lights up red.

## 4 **Phonebook**

This button allows you to access your XLC3.4+'s list of saved names and numbers. See page 21.

## 5 **TALK**

This button allows you to make

## **XLC3.4+ HANDSET - Quick Reference Guide**

or answer phone calls. It lights up green during a call.

### **6 Arrow Buttons (UP / DOWN)**

Press **UP** or **DOWN** arrows to navigate through the menus.

In standby mode, press **UP** or **DOWN** to access your Caller List.

### **7 MENU Button**

Press this button to engage your phone's available options. See page 19 for details.

### **8 Customer Service Button:**

press the blue button for direct access to a Customer Care Representative.

### **9 MUTE / BACK (EDIT) Button**

**Mute:** Allows you to conduct private conversations you don't want heard (during a call).

**Back:** In MENU mode, allows you to return to the previous screen.

**(Edit):** When a phone number is displayed, allows you to toggle between 7/10/11 digit formats for the number you are viewing.

### **10 FLASH / EXIT**

**FLASH:** While on a call, press **FLASH / EXIT** to receive another incoming call. (Call Waiting service is required.)

**EXIT:** In MENU mode, allows you to return to standby mode.

### **11 RD / P (Redial / Pause)**

Press to redial last number dialed or insert pause (two seconds) when programming memories or pre-dialing.

### **12 Headset**

A 2.5 mm headset can be used in the Headset Port. (We recommend the Plantronics MI75C headset.)

### **13 TONE**

Press to select the audio tone for the handset. See page 16.

### **14 Intercom**

Press to call other handset on system.

### **15 RINGER ON / OFF**

Switch to turn handset ringer on or off.

### **16 NECKLOOP**

A 3.4B mm neckloop can be used in the Neckloop Port. (We recommend the Clarity CE30 Neckloop.)

### **17 Belt Clip**

Belt clip available upon request.

### **18 Speaker Grill**

### **19 Battery Compartment**

# XLC3.4+ *HANDSET* - Quick Reference Guide

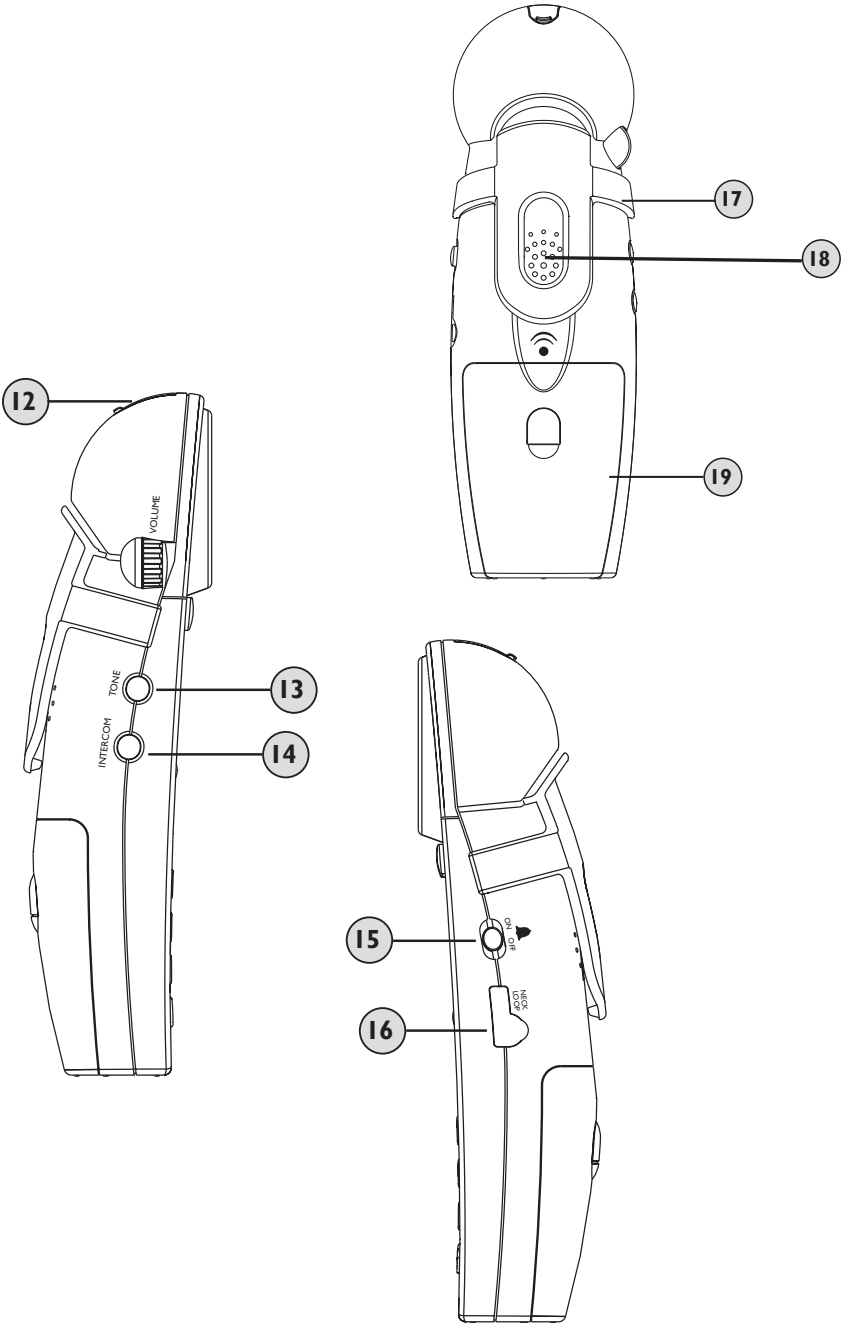

# XLC3.4+ BATTERY INFORMATION

## HANDSET

The batteries in the handset must be fully charged for 16 hours before using the telephone for the first time.

**Battery life:** Talk time is 6.5 hours, while standby is 130 hours without usage. Actual times will vary depending on the amplifier settings used. Replace batteries every two years.

**Battery spec** (as supplied with your phone): 3xAAA NiMH rechargeable batteries, (1.2V 600mAh NiMH - model 60AAAHC, GPI International Ltd. or KH-44AAA-J600, Yiyang Corun Battery Co., Ltd)

—  
To replace batteries, remove the handset battery cover and install new batteries, then close battery cover.

## BASE

The base backup batteries ensure the functionality of your cordless phone (3-4 hours) in case of a power outage.

When the base unit operates in battery mode (no AC power), the base POWER light

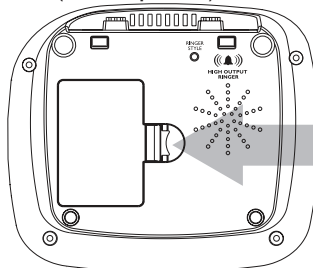

Open battery compartment door here.

will blink once every two seconds.

To install batteries in the base:

1. Turn base over and open battery compartment door.
2. Install batteries according to the polarity shown inside the battery compartment.

**NOTE: To replace handset batteries or to install base backup batteries, use ONLY standard rechargeable AAA NiMH batteries - 600mAh.**

## LOW BATTERY INFORMATION

### Handset

1. The battery icon on the screen shows no bars; the screen displays “Low Battery”.
2. The handset beeps every two seconds in OFF HOOK mode.
3. The TALK button blinks green twice every 15 seconds in standby mode. It will not flash an alert in OFF HOOK mode.

### Base (if optional batteries are installed)

1. The POWER light will blink green once every five seconds.

**WARNING: Use rechargeable batteries only.**

**Do NOT use alkaline batteries!**



## XLC3.4+ **PLACING & ANSWERING CALLS**

### TO PLACE A CALL:

1. Press **TALK**, then dial the number using the numeric keypad. See lighting pattern for the TALK button on the bottom of the page.
2. Adjust the volume to the most comfortable level - using the Volume Control and BOOST button (if necessary).
3. Press the **STONE** button on the side of the handset to adjust the tonality of the incoming voice to the most comfortable level.

**WARNING: VOLUME MAY BE LOUD!**

### NOTE:

1. If the Voice Assist function is enabled, you will hear the digits of the incoming phone number.
2. Step 1 above can be replaced with one of the following options:
  - Dial from CID records: Choose a record from your Caller List (see page 17), then press **TALK**.
  - Dial from PHONEBOOK: Choose a record from your Phonebook (see page 18), then press **TALK**.
  - Pre-dial: before pressing **TALK**, dial the number you wish to call; digits will display on the screen; press **TALK** when the number is complete.

Follow with steps 2-3 above to enjoy a clear and comfortable phone conversation.

### TO ANSWER A CALL:

1. When phone is ringing, press **TALK** to answer the call.
2. Adjust the volume and tone of the incoming voice according to your preferences.
3. When finished, press **TALK** to hang up.

### NOTE:

1. For an explanation of the TALK button light, see the bottom of the page.
2. If you have CID service, note the incoming phone number displayed on your screen.
3. If the Voice Assist function is enabled, you will hear the digits of the incoming phone number.
4. At any point during the conversation, press the speakerphone button  to switch to handsfree mode. Use the volume control for adjusting the level of the incoming audio. Switch back to earpiece mode by pressing the speakerphone button again.

### Talk Button Lighting Pattern

Green: Phone is in use.

Flashing Green every 15 seconds in standby mode: Low batteries.

# XLC3.4+ VOLUME & TONE ADJUSTMENTS

The BOOST button engages the amplifier, controlling the phone's loudness. When the VOLUME dial is adjusted and the BOOST button is pressed, the phone can reach up to 50dB of gain. **WARNING: VOLUME MAY BE LOUD. PROCEED WITH CARE.**

## BOOST On / Off

The BOOST button controls the loudness of the receiver. Once the BOOST button is pressed, an extra level of amplification is added over the entire range of volume control.

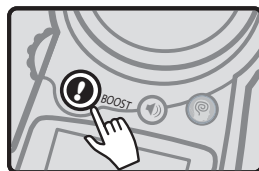

## VOLUME Control Wheel

During a call, the dial on the side controls the level of volume for handset and speakerphone. The volume dial provides up to 16dB of volume before the BOOST button is activated. Once the BOOST button is pressed, the XLC3.4+ will provide up to 50dB of amplification.



## Auto Boost

(For turning Auto Boost On or Off, see page 24.)

**ON** – When the Auto Boost is set to ON, the Boost function will be ON every time a call starts. If the phone hangs up, the Boost function will remain ON.

**OFF** – When the Auto Boost is set to OFF, the Boost function will be OFF at the beginning of all calls. Every time a call starts, the user will need to press the **BOOST** button in order to gain the extra level of amplification.

## TONE

Press the **TONE** button to change the style of

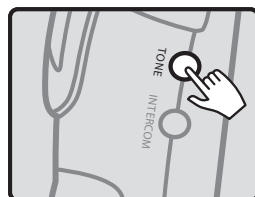

## XLC3.4+ VOLUME & TONE ADJUSTMENTS

amplification. Switching audio tones will change how the telephone conversation sounds to you.

In order to achieve the best audio experience, we recommend the following:

1. Adjust the Volume Control and enable the Boost function (if needed). (Lower the volume level to minimum (VOL 0) before activating the Boost feature.)
2. Press the **TONE** button to toggle between the available tone settings.

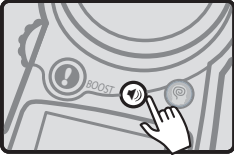

### Speakerphone

To switch to speakerphone mode, press the **SPK** button .

The display shows the speakerphone mode (see page 18).

## XLC3.4+ CALLER ID FUNCTION

Your XLC3.4+ is CID / CWCID compatible (optional service, purchased from your local telephone service provider).

When your phone is ringing, the screen shows the name and number of the person calling you. This information will be stored in the Caller List on your phone.

To access this list, and for further details regarding this function, press **UP** or **DOWN** in standby mode, and / or follow the instructions under CALLER LIST (page 20).

**NOTE:** If you have CID service, the date and time will automatically be set after the first incoming call.

## XLC3.4+ PHONEBOOK

To access your phone's stored records (Phonebook), and for further details regarding this feature, press the **Phonebook** button  on the handset, and / or follow the instructions under PHONEBOOK (page 21).

## XLC3.4+ SCREEN DETAILS

### IMPORTANT:

*In standby mode, the screen displays the date and time, handset number (for the first 10 seconds of inactivity), and date and time (after the first 10 seconds of inactivity).*

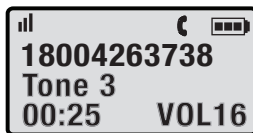





### SCREEN ICONS AND SYMBOLS

-  Battery charge level

When the icon displays just one bar, return the handset to the charger.

-  New calls indicator

There are new calls in your Caller List.

-  The phone is in a call, in speakerphone mode.
-  The phone is in a call, in earpiece mode.
-  New voicemail (separate service).
-  Handset is connected to base, and in range.

### EXAMPLE 1 (above):

- Phone is in a call, earpiece mode.
- Number that was dialed: 18004263738.
- Tone setting is 3.
- Volume level is 16.
- Call timer: 25 seconds since the beginning of the call.



### EXAMPLE 2 (above):

- Phone is in standby; more than 10 seconds since the phone was active.
- Date: April 25.
- Time: 12:38AM.
- There are new calls in the Caller List.
- There is new voicemail (service from the local phone service provider).

## XLC3.4+ TELEPHONE MENU

To start the setup process, press **MENU**. You will see the list of features to be set up on your new XLC3.4+.

At any point during the navigation of the MENU options, you can press **MUTE / BACK** to go back to the previous screen, or you can press **FLASH / EXIT** to return to standby mode (exit setup).

To navigate through the menu options, press **UP** or **DOWN** arrows.

While in MENU mode, note the cursor on the top row, to the left of the text. It indicates that the feature displayed on the upper row is active. Press **MENU** to select that feature or option.

The SETUP menu allows you to choose your preferences for the following features of your new XLC3.4+:



- **Caller List** - to view and manage the information for your incoming calls - CID / CWCID service (required from your local telephone company);
- **Phonebook** - to view and manage your saved records (names and numbers for your frequently dialed locations);
- **Ringer Setup** - to choose ringer tones, set ringer volume, turn keypad tones on or off (default: On);
- **Visual Ring** - to turn your handset visual ringer on or off (default: On);
- **Auto Boost** - to enable Boost function to be active at the beginning of all calls (default: Off);
- **Phone Setup** - to re-establish registration to the base, to enable Auto Talk function (default: Off), to enable Voice Assist feature (default: On), to enable Any Key Answer (default: Off), to enable Outgoing Speech Amplification (default: Off), to choose the language you wish to use (default: English), to choose the dial mode needed for your specific setup (default: Tone), to adjust the contrast of your handset screen (default: medium);
- **Date & time** - to allow you to manually set the date and time; the date (month and day only) and time will be set during the first incoming call, if you subscribe to CID service from your local telephone service provider.

## XLC3.4+ MENU - CALLER LIST

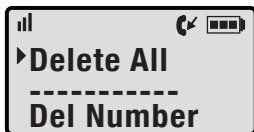
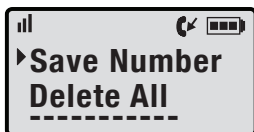
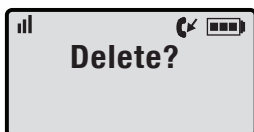
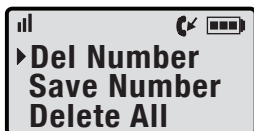
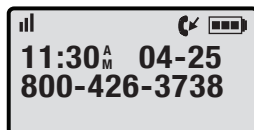
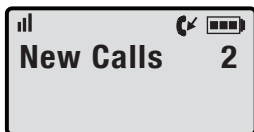

If you have new calls, you will notice the New Calls icon to the left of the battery level indicator (upper right corner).

In standby mode, press **MENU** twice.

Your screen displays the number of new calls (which have not been reviewed yet).

Press **UP** or **DOWN** to review the records in your call history (up to 40 records).

For each record, the screen alternates between showing the date / time of call and phone number, and the name associated with the phone number that called you.

Press **MUTE / BACK** to review the available formats for the record: 7 digits (no area code), 10 digits (area code + number), 11 digits (1+area code+number). The screen displays the new numbers.

When the format number is correct, press **TALK** if you wish to dial the number back.

If you wish to save or delete the record from your memory, press **MENU** (after formatting the number). You will see the options available for that record. From here, choose one of the paths described below:

- To delete the record, press **MENU** once. The screen displays "Delete?". Press **MENU** to delete (screen displays OK and you hear five beeps), or **MUTE / BACK** to return to previous screen.
- To save the number, press **DOWN** once, then press **MENU**. You can edit the number and then the name associated with the record. Press **MUTE / BACK** to delete the previous character; press **UP** or **DOWN** to move cursor within name. Use keypad to add characters to the name.  
Press **MENU** to save the number to your phonebook.
- To delete all records, press **DOWN** twice, then press **MENU**. The screen displays "Delete All?". Press **MENU** to delete all records (screen displays "OK" and you hear five beeps), or press **MUTE / BACK** to return to previous screen.

## XLC3.4+ MENU - PHONEBOOK

To access your phonebook from standby, press **MENU** once to enter the menu, press **DOWN** once, press **MENU** again to select.

Use **UP** or **DOWN** to browse through your saved records.

To dial one of your saved numbers, press **TALK** when it is shown on the screen.

To add a number, edit a number, delete a number or delete all numbers, press **MENU** while viewing a saved record. From here, choose one of the paths described below:

- Press **MENU** to select “Add Number” option. You will be prompted to enter the number as you will dial it. To edit the number before saving it, use **MUTE / BACK** to delete the last digit (one at a time); use **UP** or **DOWN** to move within the number without deleting all digits.

When finished, press **MENU** to save the number.

You will be prompted to enter the name for the number you saved. Use the numeric keypad to enter the name to be saved.

When finished, press **MENU** to save the number. Screen will display “OK” and you will hear five beeps.

- To edit the saved record while viewing it, press **DOWN** to advance the row that reads “Edit Number” to the top of the screen. Press **MENU** to select this option.

You will be prompted to edit the number - use **UP** or **DOWN** to move the cursor, or use **MUTE / BACK** to delete the last digit. Press **MENU** when the editing is complete.

You will be prompted to edit the name. Use the same controls as above.

Press **MENU** to save your edited record. Screen will display “OK” and you will hear five beeps.

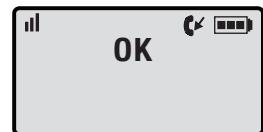
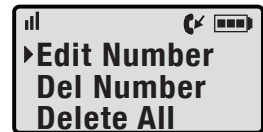
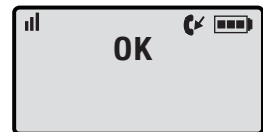
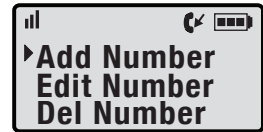
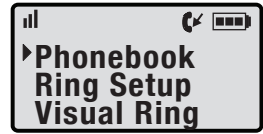

## XLC3.4+ MENU - PHONEBOOK

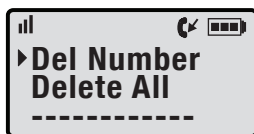

- To delete the saved record, press **DOWN** twice to advance the row that reads “Del Number” to the top of the screen.

Press **MENU** to select this option.

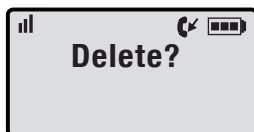

The screen displays “Delete?”. Press **MENU** to delete (screen displays “OK” and you hear five beeps), or **MUTE / BACK** to return to previous screen.

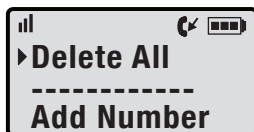

- To delete all records, press **DOWN** three times, to advance the row that reads “Delete All” to the top of the screen. Press **MENU** to select this option.

The screen displays “Delete All?”. Press **MENU** to delete all records (screen displays “OK” and you hear five beeps), or **MUTE / BACK** to return to previous screen.

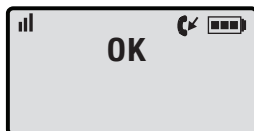

## XLC3.4+ MENU - RINGER SETUP

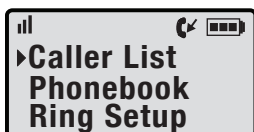

In standby mode, press **MENU**.



Press **DOWN** arrow twice, to advance the row that reads “Ring Setup” to the top of the screen.

Press **MENU** to enter the ringer setup.



You will see the available options for your ringer.

From here, choose one of the paths described below:



## XLC3.4+ MENU - RINGER SETUP

- In order to adjust the ringer volume, the RINGER ON / OFF switch on the side of the XLC3.4+ must be set to the ON position. Use **UP** or **DOWN** to reach the desired level of ring loudness. When finished, press **MENU** to save your setting.

Screen will display “OK” and you will hear five beeps.

If the RINGER ON / OFF switch is set to OFF, the screen displays “Ringer Off” (middle of screen) with no sound made. Turn ringer volume switch **ON** or return phone to standby.

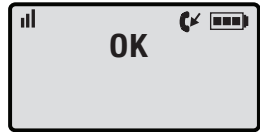
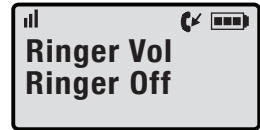

- To adjust the ringer tone, press **DOWN** to advance the row that reads “Ringer Tone” to the top of the screen. Press **MENU** to select this option.

Use **UP** or **DOWN** to scroll through the available ring tones.

Press **MENU** to save the setting you selected. Screen will display “OK” and you will hear five beeps.

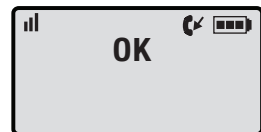
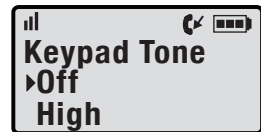
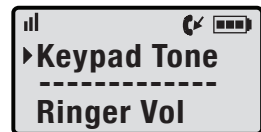
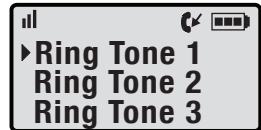

- To turn the keypad tones high, low or off, press **DOWN** twice to advance the row that reads “Keypad Tone” to the top of the screen.

Press **MENU** to select this option.

Use **UP** or **DOWN** to make your selection - indicated by the cursor on the left of the screen.

Press **MENU** to save your selection. Screen will display “OK” and you will hear five beeps.

## XLC3.4+ MENU - VISUAL RING (Handset)



In standby mode, press **MENU**.

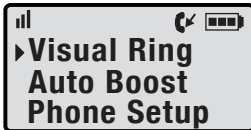

Press **DOWN** arrow three times, to advance the row that reads “Visual Ring” to the top of the screen.

Press **MENU** to enter the handset visual ringer On / Off setup.

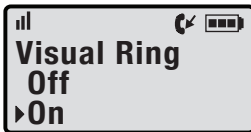

Use **UP** or **DOWN** to make your selection, indicated by the cursor on the left of the screen. Press **MENU** to save your selection. Screen will display “OK” and you will hear five beeps.

**NOTE:** This option refers to the handset visual ringer only.

## XLC3.4+ MENU - AUTO BOOST



In standby mode, press **MENU**.



Press **DOWN** arrow four times, to advance the row that reads “Auto Boost” to the top of the screen.

Press **MENU** to enter the Auto Boost On / Off setup.



Use **UP** or **DOWN** to make your selection, indicated by the cursor on the left of the screen.

Press **MENU** to save your selection. Screen will display “OK” and you will hear five beeps.

# XLC3.4+ MENU - PHONE SETUP

In standby mode, press **MENU**.

Press **DOWN** arrow five times, to advance the row that reads "Phone Setup" to the top of the screen.

Press **MENU** to enter the Phone Setup submenu.

The Phone Setup submenu allows you to adjust the following features:

- Register
- Auto Talk (On / Off, default: Off)
- Voice Assist (Voice Asst: On / Off; default: On) - English/French
- Any Key Answer (On / Off; default: Off)
- Language (English/French/Spanish, default: English)
- Dial Mode (Tone / Pulse, default: Tone)
- Contrast (1-5, default: 3)

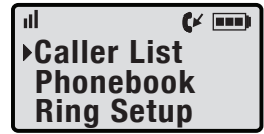

From here, choose one of the paths described below:

## • Register

Press **MENU** to access this function. See details on page 28.



## • Auto Talk

Press **DOWN** once to advance the row reading "Auto Talk" to the top of the screen.

Press **MENU** to enter this option.

Use **UP** or **DOWN** to make your selection, indicated by the cursor on the left of the screen.

Press **MENU** to save your selection. Screen will display "OK" and you will hear five beeps.



## • Voice Assist

Press **DOWN** twice to advance the row reading "Voice Asst" to the top of the screen.

This option activates the audio numbers - both for the phone numbers dialed, as well as the incoming phone numbers (with optional CID service from your local



## XLC3.4+ MENU - PHONE SETUP

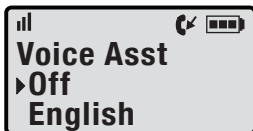

phone service provider.)

Press **MENU** to enter this option.

Use **UP** or **DOWN** to make your selection, indicated by the cursor on the left of the screen.

Press **MENU** to save your selection. The screen will display "OK" and you will hear five beeps.

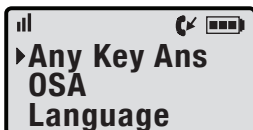

### • Any Key Answer

Press **DOWN** three times to advance the row reading "Any Key Ans" to the top of the screen. This feature allows you to answer the call by pressing any numeric key on the handset, rather than pressing **TALK** and Speakerphone.

Press **MENU** to enter this option.

Use **UP** or **DOWN** to make your selection, indicated by the cursor on the left of the screen.

Press **MENU** to save your selection. The screen will display "OK" and you will hear five beeps.

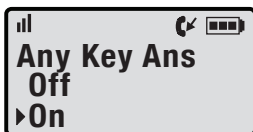

### • OSA (Outgoing Speech Amplification)

**WARNING: Voice volume level may be loud. We recommend that you turn on the OSA function ONLY if your voice is considered too quiet.**

Press **DOWN** four times to advance the row reading "OSA" to the top of the screen. This feature allows you to make your voice louder during a call.

Press **MENU** to enter this option.

Use **UP** or **DOWN** to make your selection, indicated by the cursor on the left of the screen.

Press **MENU** to save your selection. The screen will display "OK" and you will hear five beeps.

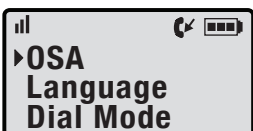

### • Language

Press **DOWN** five times to advance the row reading "Language" to the top of the screen.

Press **MENU** to enter this option.

Use **UP** or **DOWN** to make your selection, indicated by the cursor on the left of the screen.

Press **MENU** to save your selection. The screen will

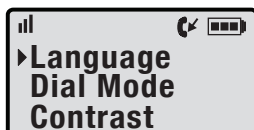

# XLC3.4+ MENU - PHONE SETUP

display “OK” and you will hear five beeps.

• **Dial Mode**

Press **DOWN** six times to advance the row reading “Dial Mode” to the top of the screen.

Press **MENU** to enter this option.

Use **UP** or **DOWN** to make your selection, indicated by the cursor on the left of the screen.

Press **MENU** to save your selection. The screen will display “OK” and you will hear five beeps.

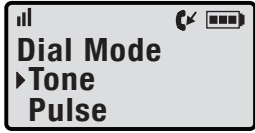
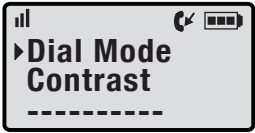

• **Contrast**

Press **DOWN** seven times to advance the row reading “Contrast” to the top of the screen.

Press **MENU** to enter this option.

Use **UP** or **DOWN** to make your selection, indicated by the cursor on the left of the screen. There are five levels available (default: Level 3).

Press **MENU** to save your selection. The screen will display “OK” and you will hear five beeps.



# XLC3.4+ MENU - DATE & TIME

In standby mode, press **MENU**. Press **DOWN** arrow six times, to advance the row that reads “Date & Time” to the top of the screen.

Press **MENU** to enter the date and time setup.

Use the numeric keypad to enter the date (follow format on screen). Press **MENU** to save your selection.

Use the numeric keypad to enter the time (follow format on screen).

Press **MENU** to save your selection. The screen will display “OK” and you will hear five beeps.



# XLC3.4+ **HANDSET REGISTRATION**

**Handset Needs Registration**

## **REGISTERING THE XLC3.4+**

In order to use the XLC3.6+HS (white color) handset (sold separately), you must register it to the XLC3.4+ base.

**Hold Base FIND Key For 5 Secs**

Pull the handset's battery tab located on the bottom of the device, and then press **MENU** to start registering or deregistering your handset from your system.

**Then Press MENU Key**

## **TO REGISTER AN UNREGISTERED HANDSET**

1. Press **MENU** to enter registration mode. You will see displayed on the screen, "Handset Needs Registration."
2. Press and hold the **FIND** key on the XLC3.4+ base for five seconds, until the base visual ringer starts flashing. Release **FIND** key on the XLC3.4+ base.
3. Press **MENU** key on the handset.
4. The screen shows "Registering..." , then "Registration Successful" (accompanied by five quick beeps).
5. Your handset is now registered to your XLC3.4+ system. Your screen will display "Handset X," (where "X" is the number of the actual handset registered, such as the second or fourth handset, etc.).

**Registering...**

**Registration Successful**

You can extend the number of handsets by using additional XLC3.6+HS handsets (sold separately).

**Register Auto Talk Voice Asst**

## **TO REGISTER YOUR HANDSET AGAIN (or to register to a different XLC3.4+ system)**

1. In standby mode, press **MENU**.
2. Press **DOWN** arrow five times to advance the row reading "Phone Setup" to the top of the screen.
3. Press **MENU** to enter the setup section. The screen displays "Register" on the screen's top row now.
4. Press **MENU** to enter the Registration section.
5. Press **MENU** again to select "Register."
6. Follow the Registration steps listed above.

**Register Register Deregister**

**Register Register Deregister**

## **TO DEREGISTER THE HANDSET**

1. See the six steps listed above, then press **MENU** to select "Deregister."
2. **Your handset will deregister from your base as soon as you press MENU.** The screen will show "Handset X Deregistered" (again, where "X" is the number of the handset registered), then "Handset Needs Registration."

**HANDSET 1 Deregistered**

### **The unit will not operate / no dial tone:**

- Verify the AC adapter is securely plugged into the AC outlet, the base and the telephone.
- Verify the telephone line cord is securely plugged into the wall jack and the telephone.
- Make sure the handset battery is fully charged.
- Make sure the battery has been placed in the battery compartment correctly. (The circular metal contacts on battery need to touch the metal springs inside battery compartment.)
- Verify the telephone is in the correct dialing mode: Tone (touch) or Pulse (rotary).
- Make sure you are in the usable range of the base station.

### **The phone does not ring when you receive a call:**

- Make sure the RINGER switch on both handset and base is set to ON.
- Verify the AC adapter is securely plugged into the AC outlet, the base and the telephone.
- Verify the telephone line cord is securely plugged into the wall jack and the telephone.
- Make sure you are within the usable range of the base station.
- You may have too many extensions on your line. Try unplugging a few devices.

### **Noise, interference or other calls heard while using the handset:**

- Make sure you are within the usable range of the base station.
- Make sure the handset battery is fully charged.
- Try relocating the base unit to another location.
- Make sure the AC adapter is not plugged into the wall outlet with other appliances.

## **XLC3.4+ TROUBLESHOOTING**

### **Phone will not hold charge:**

- Make sure the charging contacts on the handset and base are free of dust and dirt. While unplugged, clean the contacts with a soft cloth.
- Make sure IN USE / CHARGE light on the base is lit when the handset is in the cradle.
- If necessary, replace the handset battery.

### **Difficulty in placing or receiving calls:**

- Move closer to the base and try again.
- Make sure you have selected the correct dialing mode, tone or pulse.
- Make sure the AC adapter is not plugged into a wall outlet with other appliances. Disconnect for 5-10 seconds then reconnect. Place the handset back on the base and reinsert the AC adapter.
- Make sure the handset battery is fully charged.

### **Your handset screen is displaying “Searching...”:**

- Verify that the AC adapter is plugged into the base and into the wall outlet.
- The handset is out of range or the power to the base is unplugged.
- Move closer to the base.
- Place the handset into the base until the screen returns to standby mode. It will take approximately 5-10 seconds for the handset to register to the base.
- Handset may need to be re-registered to the base manually. Follow instructions on page 28.



### Screen displays “Battery Low”:

- Handset batteries are low on charge; return the handset to the base to recharge the batteries.

### TALK button is blinking green (fast pace):

- The base is trying to locate the handset; press **TALK** to end the FIND paging process and return the handset to the base.

### Base POWER light blinks green once every second:

- The power adapter may not be plugged in. Verify AC adapter is plugged into proper wall outlet.

### Base POWER light blinks green every five seconds:

- The power adapter may not be plugged in. Verify AC adapter is plugged into proper wall outlet.
- The base batteries may be “low” (their charge). If necessary, replace batteries.

# XLC3.4+ TECHNICAL SPECIFICATIONS

## General

Frequency: 1.9GHz DECT6.0  
Amplification: 50dB

## Handset Unit

Product in Inches: (L x W x H): 7.25 x 2 x 1.25  
Weight in Pounds: 0.5 lb.

## Base

Product in Inches: (L x W x H): 5.3 x 4.5 x 3.6  
Weight in Pounds: 0.44 lb.  
Power Supply: AC Adapter: Input: 100V-120V AC; Output: 6VDC, 600 mA;  
Model: RJ-AS060600U501, Shenzhen Ruijing Industrial Co., Ltd.  
or Model: S006AKU0600060, Ten Pao International Ltd.

## Additional Handsets

Clarity part number: XLC3.6+HS (white color)  
The XLC3.4+ will support a maximum of four (4) handsets registered to a base, and two (2) handsets maximum used in the same call.

***(Additional Handsets sold separately.)***

## Battery Information (base and handset)

Battery Type: 1.2V 600mAh NiMH - model 60AAAHC, GPI International Ltd.  
or KH-44AAA-J600, Yiyang Corun Battery Co., Ltd

Battery Life Talk Time: 6.5 Hours

Battery Life Standby: 130 Hours

Contact Clarity customer service for information on purchasing additional handsets or replacement battery.

## Clarity contact information:

**Customer Service:** 800-426-3738

**Address:** 1470 Exposition Way, Suite 130  
San Diego, CA 92154

## **PARTY RESPONSIBLE FOR REGULATORY COMPLIANCE:**

**Clarity, a Division of Plantronics, Inc.**  
**6131 Preservation Drive**  
**Chattanooga, TN 37416**  
**Phone: 800-426-3738**

### **Part 68 of FCC Rules Information**

a) This equipment complies with Part 68 of the FCC rules and the requirements adopted by the ACTA. On the bottom of this equipment is a label that contains, among other information, a product identifier in the format US:AAAEQ##TXXXX. If requested, this number must be provided to the telephone company.

b) A plug and jack used to connect this equipment to the premise's wiring and telephone network must comply with the applicable FCC Part 68 rules and requirements adopted by the ACTA. A compliant telephone cord and modular plug, RJ11C USOC, is provided with this product. It is designed to be connected to a compatible modular jack that is also compliant. See installation instructions for details.

c) The REN is used to determine the number of devices that may be connected to a telephone line. Excessive RENs on a telephone line may result in the devices not ringing in response to an incoming call. In most but not all areas, the sum of RENs should not exceed five (5.0). To be certain of the number of devices that may be connected to a line, as determined by the total RENs,

contact the local telephone company. For products approved after July 23, 2001, the REN for this product is part of the product identifier that has the format US:AAAEQ##TXXXX. The digits represented by ## are the REN without a decimal point (e.g., 03 is a REN of 0.3). For earlier products, the REN is separately shown on the label.

d) If this telephone equipment causes harm to the telephone network, the telephone company will notify you in advance that temporary discontinuance of service may be required. But if advance notice isn't practical, the telephone company will notify the customer as soon as possible. Also, you will be advised of your right to file a complaint with the FCC if you believe it is necessary.

e) The telephone company may make changes in its facilities, equipment, operations or procedures that could affect the operation of the equipment. If this happens the telephone company will provide advance notice in order for you to make necessary modifications to maintain uninterrupted service.

f) If trouble is experienced with this telephone equipment, for repair or warranty information, please contact Clarity, 800-426-3738. If the equipment is causing harm to the telephone network, the telephone company may request that you disconnect the equipment until the problem is resolved.

g) This telephone equipment is not intended to be repaired and it contains no repairable parts. Opening the equipment or any attempt to perform repairs will void the warranty. For service

## XLC3.4+ REGULATORY COMPLIANCE

call 800-426-3738.

h) Connection to party line service is subject to state tariffs. Contact the state public utility commission, public service commission or corporation commission for information.

i) If your home has specially wired alarm equipment connected to the telephone line, ensure the installation of this telephone equipment does not disable your alarm equipment. If you have questions about what will disable alarm equipment, consult your telephone company or a qualified installer.

j) This telephone equipment is hearing aid compatible.

### **Customer-Owned Coin/Credit Card Phones**

To comply with state tariffs, the telephone company must be given notification prior to connection. In some states, the state public utility commission, public service commission or corporation commission must give prior approval of connection.

### **Part 15 of FCC Rules Information**

This device complies with Part 15 of the FCC Rules. Operation is subject to the following two conditions: (1) This device may not cause harmful interference, and (2) this device must accept any interference received, including interference that may cause undesired operation.

Your equipment has been tested and found to comply with the limits of a Class B digital device, pursuant to Part 15 of FCC rules. These limits are designed

to provide reasonable protection against harmful interference in residential installation.

This equipment generates, uses and can radiate radio frequency energy and, if not installed and used in accordance with the instructions, may cause harmful interference to radio communications. However, there is no guarantee that interference will not occur in a particular installation; if this equipment does cause harmful interference to radio or television reception, which can be determined by turning the equipment off and on, you are encouraged to try to correct the interference by one of the following measures:

1. Where it can be done safely, reorient the receiving television or radio antenna.
2. To the extent possible, relocate the television, radio or other receiver with respect to the telephone equipment. (This increases the separation between the telephone equipment and the receiver.)
3. Connect the telephone equipment into an outlet on a circuit different from that to which the television, radio or other receiver is connected.
4. Consult the dealer or an experienced Radio/TV Technician for help.

Privacy of communications may not be ensured when using this phone.

**WARNING:** To maintain the compliance with the FCC's RF exposure guideline, place the base unit at least 20 cm from nearby persons.

## XLC3.4+ REGULATORY COMPLIANCE

For body worn operation, this handset has been tested and meets the FCC RF exposure guidelines when used with the Clarity and Plantronics accessories supplied or designated for this product. Use of other accessories may not ensure compliance with FCC RF exposure guidelines.

**WARNING:** Changes or modifications to this equipment not expressly approved by the party responsible for compliance could void the user's authority to operate the equipment.

### Industry Canada Technical Specifications

This device complies with Industry Canada license - exempt RSS standard(s). Operation is subject to the following two conditions: (1) This device may not cause interference, and (2) this device must accept any interference, including interference that may cause undesired operation of the device.

This product meets the applicable Innovation, Science and Economic Development Canada technical specifications.

Privacy of communications may not be ensured when using this phone.

Before installing this equipment, users should ensure that it is permissible to be connected to the facilities of the local telecommunications company. The equipment must also be installed using an acceptable method of connection. In some cases, the company's inside wiring associated with a single line individual service may be extended by means of a

certified connector assembly (telephone extension cord). The customer should be aware that compliance with the above conditions may not prevent degradation of service in some situations. Repairs to certified equipment should be made by an authorized Canadian maintenance facility designated by the supplier.

Any repairs or alterations made by the user to this equipment, or equipment malfunctions, may give the telecommunications company cause to request the user to disconnect the equipment.

Users should ensure for their own protection that the electrical ground connections of the power utility, telephone lines and internal metallic water pipe system, if present, are connected together. This precaution may be particularly important in rural areas.

**WARNING:** Users should not attempt to make such connections themselves, but should contact the appropriate electrical inspection authority, or electrician, as appropriate.

The Ringer Equivalence Number is an indication of the maximum number of terminals allowed to be connected to a telephone interface. The termination on an interface may consist of any combination of devices subject only to the requirement that the sum of the Ringer Equivalence Numbers of all the devices does not exceed five.

This Class B digital apparatus complies with Canadian ICES-003.

(The term "IC:" before the certification/ registration number only signifies that the Industry Canada technical specifications were met.)

## XLC3.4+ WARRANTY INFORMATION

### **Incidental or Consequential**

**Damages:** Neither Clarity nor your retailer dealer or selling distributors have any responsibility for any incidental or consequential damages including without limitation, commercial loss or profit, or for any incidental expenses, expenses, loss of time, or inconvenience. Some states do not allow exclusion or limitation of incidental or consequential damage, so the above limitation or exclusion may not apply to you.

**Other Legal Rights:** This warranty gives you specific legal rights and you may also have other rights which vary from state to state.

To obtain warranty service, please prepay shipment and return the unit to the appropriate facility listed below.

### **Clarity Service Center**

1470 Exposition Way, Suite 130  
San Diego, CA 92154  
Tel: 800-426-3738  
Fax: 800-325-8871

### **Agility Logistics**

185 Courtneypark Drive East  
Mississauga, ON L5T 2T6  
Canada  
Tel: 800-426-3738  
Fax: 514-956-1825

Please use the original container, or pack the unit(s) in a sturdy carton with sufficient packing material to prevent damage. Include the following information:

- A proof-of-purchase indicating model number and date of purchase;
- Bill-to address;
- Ship-to address;
- Number and description of units shipped;
- Name and telephone number of person to call, should contact be necessary;
- Reason for return and description of the problem.

Damage occurring during shipment is deemed the responsibility of the carrier, and claims should be made directly with the carrier.

The following warranty and service information applies only to products purchased and used in the U.S. and Canada. For warranty information in other countries, please contact your local retailer or distributor.

**Limited Warranty:** Clarity, a division of Plantronics, Inc. ("Clarity") warrants to the original consumer purchaser that, except for limitations and exclusions set forth below, this product shall be free from defects in materials and workmanship for a period of one (1)

year from the date of original purchase (“Warranty Period”). The obligation of Clarity under this warranty shall be at Clarity’s option, without charge, of any part or unit that proves to be defective in material or workmanship during the Warranty Period.

**Exclusions from Warranty:**

This warranty applies only to defects in factory materials and factory workmanship. Any condition caused by accident, abuse, misuse or improper operation, violation of instructions furnished by Clarity, destruction or alteration, improper electrical voltages or currents, or repair or maintenance attempted by anyone other than Clarity or an authorized service center, is not a defect covered by this warranty. Telephone companies manufacture different types of equipment and Clarity does not warrant that its equipment is compatible with the equipment of a particular phone company.

**Implied Warranties:** Under state law, you may be entitled to the benefit of certain implied warranties. These implied warranties will continue in force only during the warranty period. Some states do allow limitations on how long an implied warranty lasts, so the above limitation may not apply to you.