

**CLARITY**<sup>®</sup>  
*Professional*

**XLC2**<sup>™</sup>  
CORDLESS

## Extra Loud Big Button Cordless Speakerphone



## User Guide

Clarity, a Division of Plantronics, Inc.  
4289 Bonny Oaks Drive, Chattanooga, TN 37406  
Tel: 800-426-3738 Fax: 800-325-8871  
E-mail: [claritycs@plantronics.com](mailto:claritycs@plantronics.com) Website: [www.clarityproducts.com](http://www.clarityproducts.com)

©2010 Clarity, a Division of Plantronics, Inc. All rights reserved. Clarity, Clarity Professional, XLC2, Digital Clarity Power and the amplified figure are trademarks or registered trademarks of Plantronics, Inc.  
Rev. D (09-10)

## **XLC2 Table of Contents**

<b>SAFETY INFORMATION</b>	<b>3</b>
<b>PACKAGE CONTENTS</b>	<b>7</b>
<b>INSTALLATION</b>	<b>8</b>
<b>FEATURE LIST - BASE</b>	<b>12</b>
<b>FEATURE LIST - HANDSET</b>	<b>14</b>
<b>BATTERY INFORMATION</b>	<b>17</b>
<b>PROGRAMMING/DIALING - MEMORY</b>	<b>20</b>
<b>BOOST FUNCTION INFORMATION</b>	<b>21</b>
<b>AUTO BOOST FUNCTION INFORMATION</b>	<b>22</b>
<b>OUTGOING SPEECH AMPLIFICATION</b>	<b>23</b>
<b>TROUBLESHOOTING</b>	<b>24</b>
<b>TECHNICAL INFORMATION</b>	<b>27</b>
<b>REGULATORY COMPLIANCE</b>	<b>28</b>
<b>WARRANTY</b>	<b>33</b>

## **XLC2 Important Safety Instructions**

Privacy of communications may not be ensured when using this phone.

When using your telephone equipment, basic safety precautions should always be followed to reduce the risk of fire, electric shock and injury to persons, including the following:

1. Read and understand all instructions.
2. Follow all warnings and instructions marked on the telephone.
3. Avoid contact with liquids. Do not locate base unit or handset near water, for example, near a bathtub, wash basin, sink or laundry tub, in a wet basement or near a swimming pool.
4. Avoid using a telephone (other than a cordless type) during a storm. There may be a remote risk of electrical shock from lightning.
5. Do not use the telephone to report a gas leak in the vicinity of the leak.
6. Unplug this telephone from the wall outlets before cleaning. Do not use liquid cleaners or aerosol cleaners on the telephone. Use a damp cloth for cleaning.
7. Place this telephone on a stable surface. Serious damage and/or injury may result if the telephone falls.
8. Do not cover the slots and openings on this telephone. This telephone should never be placed near or over a radiator or heat register. This telephone should not be placed in a built-in installation unless proper ventilation is provided.
9. Operate this telephone using the electrical voltage as stated

## **XLC2 Important Safety Instructions**

on the base unit or the owner's manual. If you are not sure of the voltage in your home, consult your dealer or local power company.

10. Do not allow anything to rest on the power cord or locate this product in an area where the power cord is likely to be damaged by furniture or foot traffic.

11. Do not overload wall outlets or extension cords as this can increase the risk of fire or electrical shock.

12. Never push any objects through the slots in the telephone. They can touch dangerous voltage points or short out parts that could result in a risk of fire or electrical shock. Never spill liquid of any kind on the telephone.

13. To reduce the risk of electrical shock, do not take this phone apart. Opening or removing covers may expose you to dangerous voltages or other risks. Incorrect reassembly can cause electric shock when the appliance is subsequently used.

14. Unplug this product from the wall outlet and refer servicing to the manufacturer under the following conditions: when the power supply cord or plug is frayed or damaged; if liquid has been spilled into the product; if the telephone has been exposed to rain or water; if the telephone has been dropped or the case has been damaged; if the telephone exhibits a distinct change in performance; if the telephone does not operate normally by following the operating instructions. Adjust only those controls that are covered by the operating instructions. Improper adjustment may require extensive work by a qualified technician to restore the telephone to normal operation if the telephone does not operate normally by following the operating instructions.

## **XLC2 Important Safety Instructions**

15. Never install telephone wiring during a lightning storm.

16. Never install telephone jacks in wet locations unless the jack is specifically designed for wet locations.

17. Never touch uninsulated telephone wires or terminals unless the telephone line has been disconnected at the network interface.

18. Use caution when installing or modifying telephone lines.

19. This product should be operated only from the type of power source indicated on the marking label. If you are not sure of the type of power supply to your home, consult your local power company.

20. Do not attempt to open the AC adapter. There are potentially dangerous voltages inside, and there are no serviceable parts.

21. Discontinue use of product and contact Clarity if the product overheats, has a damaged cord or plug, if the product has been dropped or damaged or if the product has come into contact with liquids.

22. Use only the AC adapter provided with this product or a replacement AC adapter provided by Clarity.

23. This phone amplifies sound to loud volumes. To prevent hearing damage, all users of the phone should be informed of the high volume capability of the phone and children should only use the phone when supervised by an adult.

24. Exposure to high volume sound levels or excessive sound pressure may cause temporary or permanent damage to your hearing. Although there is no single volume setting that is appropriate for everyone, you should always use your telephone with the volume set at moderate levels and avoid

## XLC2 Important Safety Instructions

prolonged exposure to high volume sound levels. The louder the volume, the less time is required before your hearing could be affected. If you experience hearing discomfort, you should have your hearing checked by a doctor. To protect your hearing, you should:

- A) Set the volume control in a low position and gradually increase the volume as needed. Before pressing the BOOST button, reduce the volume to the lowest level. Use the phone on the lowest volume setting as possible.
- B) Limit the amount of time you use the telephone at high volume levels.

25. If you experience a skin irritation after using this product, discontinue use and contact Clarity.

**SAVE THESE INSTRUCTIONS**

## XLC2 Package Contents

Your package includes all of the items as shown here. If there is anything missing, please contact our Customer Care department immediately.

**NOTE:** PLEASE RETAIN A COPY OF PROOF OF PURCHASE FOR YOUR RECORDS.

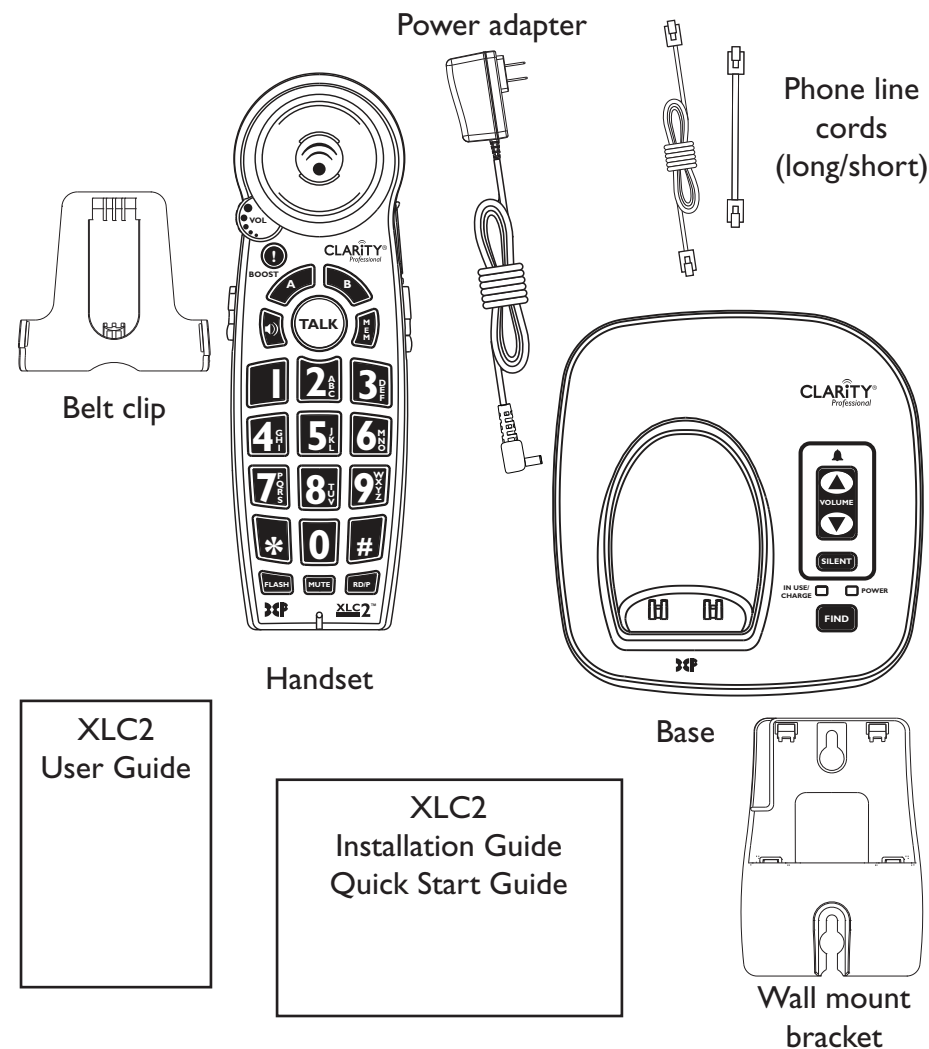

## XLC2 Installation

Connect your telephone as shown on the enclosed Quick Start guide.

Your telephone should arrive pre-assembled. To install it:

1. Remove base from package.
2. Hold one end of your XLC2's long phone line cord tightly. The correct end to hold should already be plugged into your phone's jack. Simultaneously pull the other end of the phone cord away from the phone, unraveling it and allowing you to plug that end of the cord into a wall telephone outlet.
3. Plug the loose end of the phone cord into the wall telephone outlet.
4. Hold one end of your phone's white power adapter cord tightly. The correct end to hold should already be plugged into the back of your telephone base unit. Simultaneously pull the other end of the adapter cord away from the phone, unraveling it and allowing you to plug that end of the cord into a wall electrical outlet.
5. Plug white power adapter cord on left rear of the base into a wall electrical outlet.
6. Remove handset from package.
7. Pull the handset's battery tab located on the bottom of the device in the direction of the arrow.
8. Place the handset in the base charger. The batteries in the handset must be fully charged for 10 hours before using the telephone for the first time.
9. Lift handset and press **TALK** to test. If you hear a dial tone, your telephone is ready for use. If not, check all connections again.

## XLC2 Installation

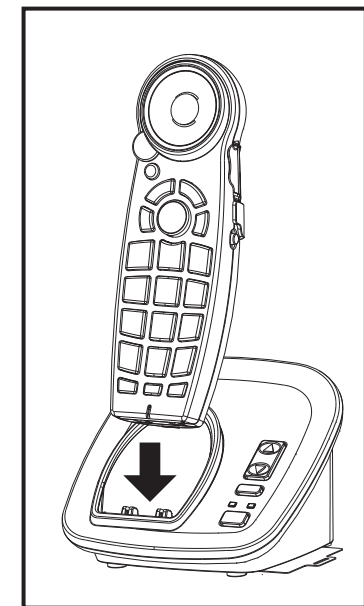
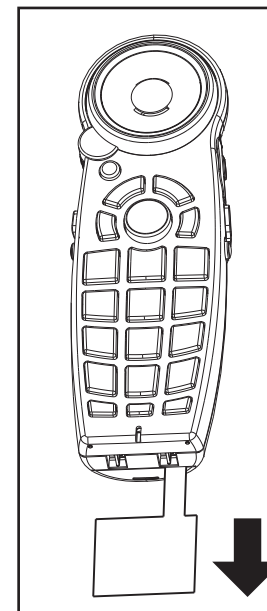
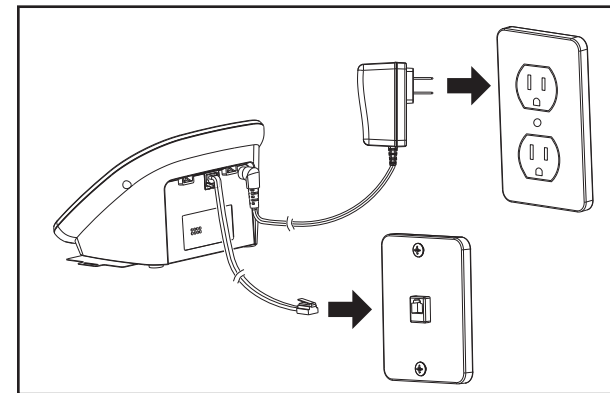
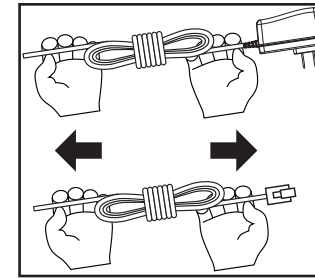

## XLC2 Wall Mounting Your XLC2

Wall mount your telephone as shown on the enclosed Quick Start guide. (This is optional.)

1. Follow the instructions in the Installation section on page 8 to remove the base and handset from the base – steps 1, 4, 6.
2. Unplug the long phone line cord from the phone jack located on the back of your XLC2. Plug one end of the short phone line cord into the same jack identified by LINE on the back of your base.
3. Install the XLC2 base onto the wall mount bracket as shown on page 11. Guide the short phone cord through the wall mount bracket as shown in the diagram.
4. Using a screwdriver, loosen the screws on your phone wall outlet (1-2 turns).
5. Plug the loose end of the short phone cord into the wall phone outlet.
6. Attach the wall mount bracket (with the XLC2 base) onto the wall phone outlet.
7. Plug the power adapter into a wall electrical outlet.
8. Pull the handset's battery tab located on the bottom of the device in the direction of the arrow.
9. Place the handset in the base and allow 10 hours for full charge.

## XLC2 Wall Mounting Your XLC2

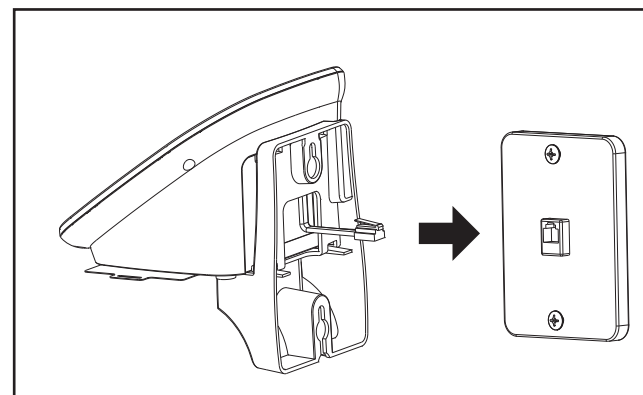
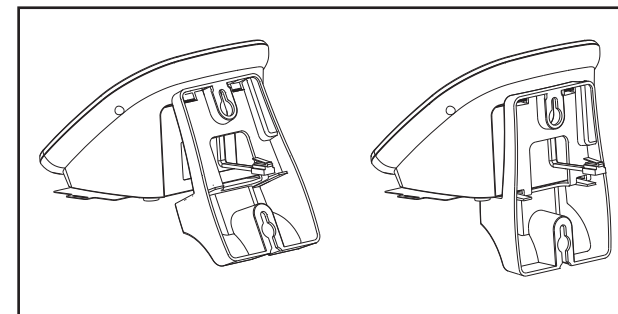
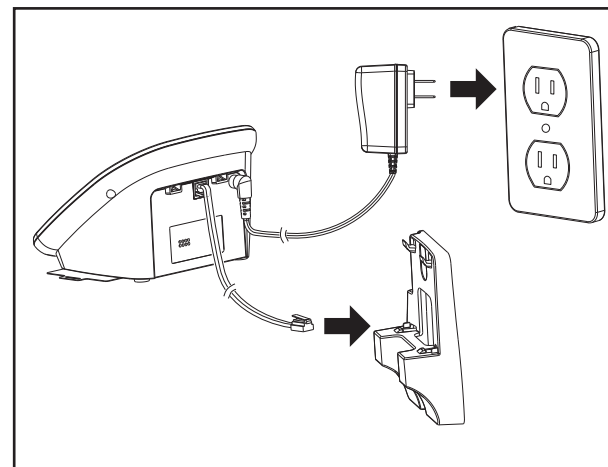

## XLC2 Feature List & Overview - Base

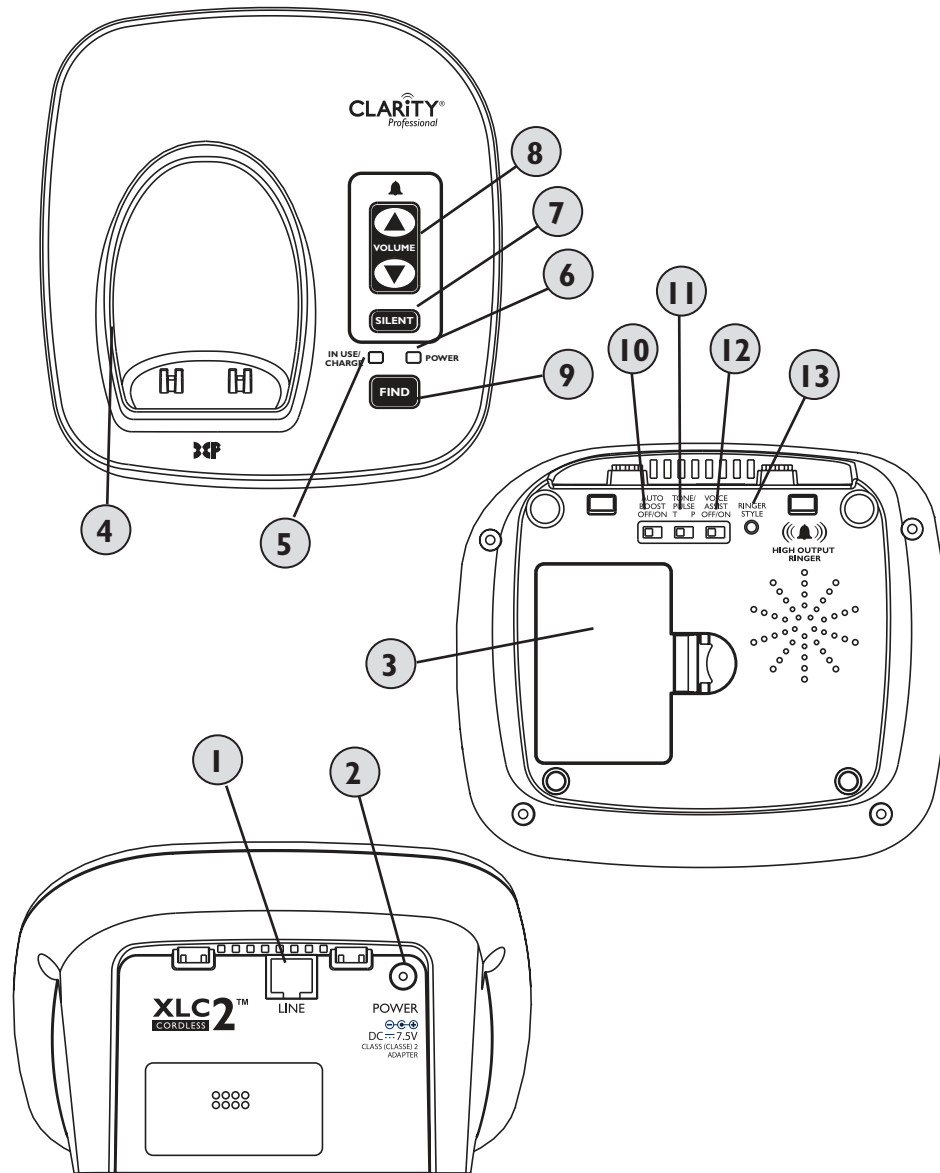

1. **LINE:** Insert one end of your phone line here.
2. **POWER:** Insert power adapter's round end here.
3. **Battery door:** Remove this to access the backup battery compartment.

## XLC2 Feature List & Overview - Base

4. **Visual Ringer (Base):** Lights up when phone rings.
5. **IN USE / CHARGE Light:** The light turns green if the phone is in use, and turns red when it is charging.
6. **POWER LED (light):** This light is lit green when the power is on.
7. **SILENT:** Press if you want to turn off the base ringer. The button is backlit with a red light when the ringer is off.
8. **VOLUME (UP / DOWN):** Use these arrow keys to increase / decrease the ringer volume on the base. The volume adjustment can only be done while the phone is not in use.
9. **FIND:** Press this key to locate the handset. Once the handset is found, press the **TALK** key to end the location sounds.
10. **AUTO BOOST OFF / ON:** BOOST override function. Sets the state of the BOOST function at the beginning of each call (see BOOST FUNCTION (AMPLIFICATION) section).
11. **TONE / PULSE:** Choose the appropriate dialing mode according to your local settings.
12. **VOICE ASSIST OFF / ON:** Set switch to **ON** if you wish to hear the numeric keys pressed during dialing, and (if your phone line is equipped with CID service, purchased separately from your local telephone service provider) the digits of the incoming call. If you do not have CID, the ON option turns on the Voice Assist function for the dialed digits only.
13. **RINGER STYLE:** Use this key to choose the most comfortable base ring tone for your environment. There are six ring tones available. (This adjustment needs to take place while the phone is not in use.)



## XLC2 Feature List & Overview - Handset

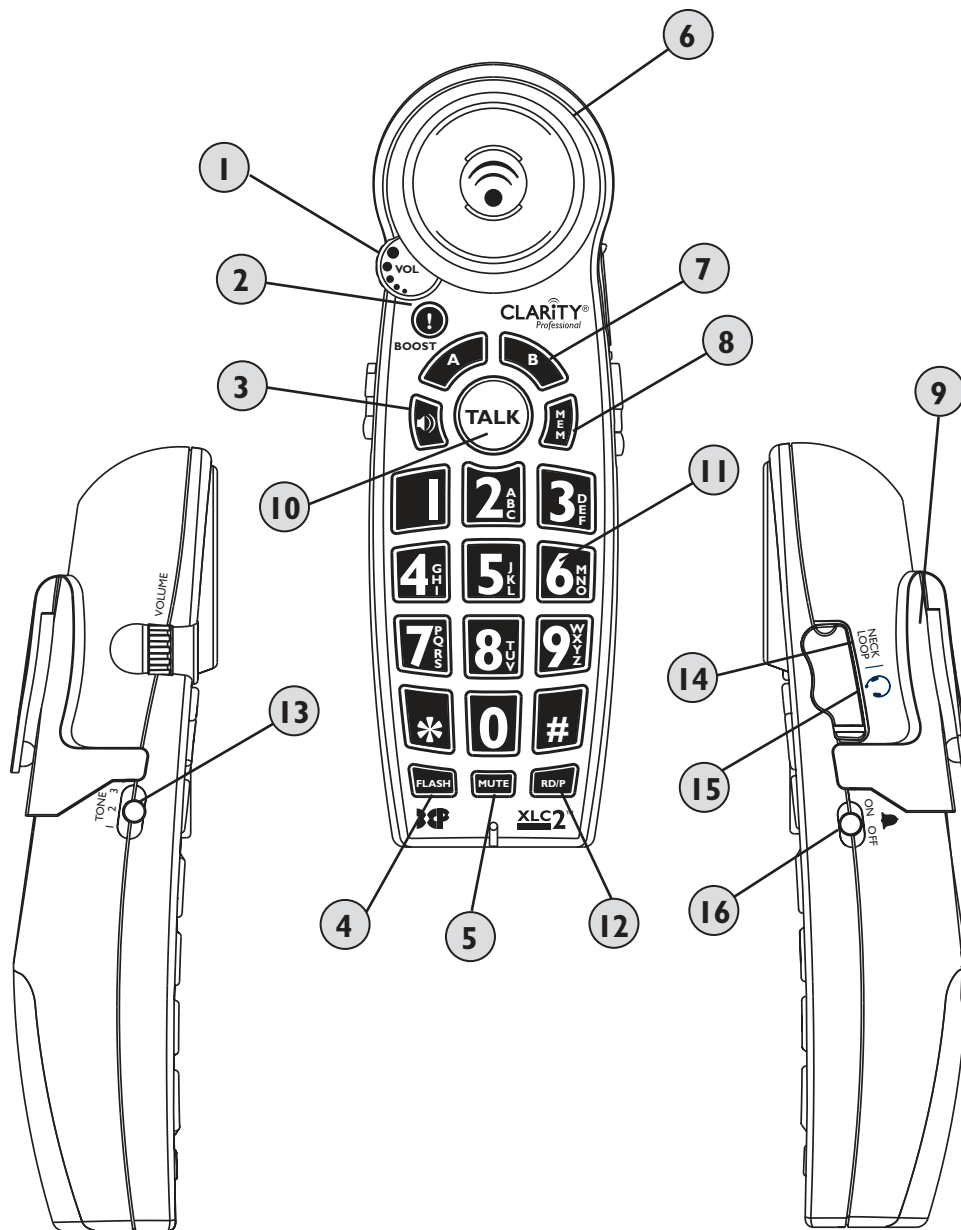

## XLC2 Feature List & Overview - Handset

**1. VOLUME Control Wheel:** Use the rotary control to increase or decrease the volume of the incoming call.

**2. BOOST:** Press this button to engage the extra amplification (see details on page 21). When the Boost function is enabled, the TALK button turns red.

**3. Speakerphone:** In TALK mode, press the Speakerphone button to go to speakerphone mode. Press Speakerphone button to return to TALK. Press **TALK** to end the call.

You can answer the phone in Speakerphone mode by pressing the Speakerphone button.

The button is backlit red when the speakerphone is active.

**4. FLASH:** Designed to use custom calling services such as Call Waiting or Three Way Calling.

**5. MUTE:** Allows you to conduct a private conversation that you do not want the person on the other end to hear. Press the MUTE button again to return to your call. The MUTE button blinks red when this function is active.

**6. Visual Ringer:** Lights up when the phone rings.

**7. A / B Memory Keys:** Two one-touch emergency memory keys labeled “A” and “B.” To dial out using either of these saved numbers, press the desired key and the handset dials out.

**8. MEM:** Use this button to program the memory keys. This button is also used in dialing the two-touch memory locations. (see details under PROGRAMMING / DIALING MEMORY KEYS section - page 20).

**9. Belt Clip:** Use the belt clip to easily carry the handset according to your needs.

## XLC2 Feature List & Overview - Handset

**10. TALK:** Press **TALK** to start an outgoing phone call or to answer an incoming call. Also, press **TALK** when the handset is found (if the FIND function is activated from the base). The TALK button lights up as per the settings below:

- green when the phone is in use, non-Boost mode;
- red when the BOOST function is engaged;
- orange when the OSA function is active;
- blinks green during incoming ring or when the base is paging the handset (FIND function is engaged) - along with the visual ringer;
- blinks green (slower) during the memory programming process.

**11. Dial Pad:** Used to dial the phone numbers. The keys also serve as the location for 10 two-touch memory locations (see details under PROGRAMMING / DIALING MEMORY KEYS section - page 20). The dial pad is backlit for ease of use.

**12. RD / P (Redial / Pause):** When you hear the dial tone, press this button to redial the last number dialed (up to 32 digits). Press this button while programming the memory keys to insert a two second pause.

**13. TONE Switch:** Use this switch to pick one of the three tone settings available (see page 21).

**14. NECKLOOP Port:** Use a standard 3.5mm neckloop with your XLC2 handset. We recommend the Clarity CE30 Neckloop.

**15. Headset Port:** Use a standard 2.5mm plug headset with your XLC2 handset. We recommend the Plantronics MI75C.

**16. RINGER ON / OFF:** Set this switch to **OFF** position if you want to turn off the handset ringer.

## XLC2 Battery Information

### HANDSET

The batteries in the handset must be fully charged for 10 hours before using the telephone for the first time.

**Battery life:** Talk time is 6.5 hours, while standby is 130 hours without usage. Actual times will vary depending on the amplifier settings used. Replace batteries every two years.

**Battery spec** (as supplied with your phone): 3xAAA NiMH rechargeable batteries, (1.2V 600mAh NiMH, 60AAAHC, GPI International Ltd.).

To replace batteries, remove the handset battery cover and install new batteries, then close battery cover.

### BASE (OPTIONAL)

The base batteries are optional (backup). You should use 3xAAA NiMH rechargeable batteries if you choose to put them in the base. The backup batteries should be AAA, NiMH, rechargeable only, rated 600mAh.

The base backup batteries ensure the functionality of your cordless phone (3-4 hours), in case of a power outage.

The batteries in the base must be fully charged for 10 hours. When the base unit operates in battery mode (no AC power), the base POWER light will blink once every two seconds.

To install batteries in the base:

1. Turn base over and remove memory card.

## XLC2 Battery Information

2. Open battery compartment door - push in the direction of the arrow.

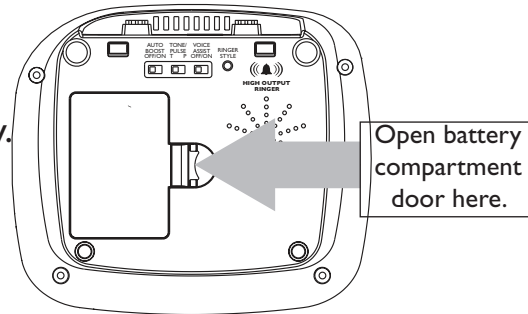

3. Install batteries according to the polarity shown inside the battery compartment.

**NOTE:** To replace handset batteries or to install base backup batteries, use **ONLY** standard rechargeable AAA NiMH batteries - 600mAh.

## XLC2 Low Battery Indication

### Handset

1. The handset beeps every 15 seconds in OFF HOOK mode. It does not beep in ON HOOK mode.
2. The TALK button blinks red twice every two seconds in ON HOOK mode. It will not flash an alert in OFF HOOK mode.

### Base (if optional batteries are installed)

1. The In Use / Charge light will blink red once every five seconds in ON HOOK mode.

**WARNING:** Use rechargeable batteries only. Do NOT use alkaline batteries!

## XLC2 Battery Safety Information

**Dispose of used batteries according to the instructions.**

1. Do not dispose of the battery in a fire as it may explode. Check with local codes for possible special disposal instructions.
2. Do not open or mutilate the battery. Released electrolyte is corrosive and may cause damage to the eyes and skin. It may be toxic if swallowed.
3. Exercise care in handling batteries in order not to short the battery with conducting materials such as rings, bracelets and keys. The battery or conduction material may overheat and cause burns.
4. Remove batteries when they are discharged and when the equipment will not be used for an extended period of time. Dispose of batteries according to local environmental laws.
5. Do not disassemble, heat, crush, deform or puncture batteries.
6. Do not attempt to charge non-rechargeable batteries.
7. Keep batteries out of the reach of children.

**WARNING:** Risk of explosion if battery is replaced by an incorrect type.

## XLC2 Programming / Dialing Memory Keys

The XLC2 has two direct (one-touch) memory locations and 10 indirect (two-touch) memory locations on the telephone (0-9) that can be programmed to dial frequently called numbers of up to 24 digits.

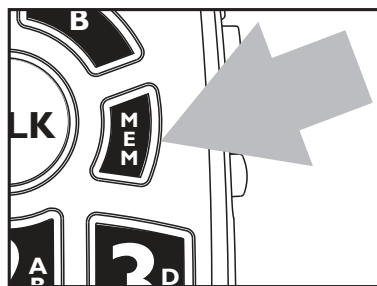

### To program a memory location:

1. Press the **MEM** button.
2. Dial the number you wish to store.
3. Press the **MEM** button again.
4. Press either the emergency button or the number on the dial pad to which you wish to store the number.
5. A long beep will indicate the programming process is complete.

**NOTE:** The TALK button blinks (green) during the programming process; it will stop blinking when the programming process is complete (at step 5, above).

To replace a stored number, simply reprogram a new number in its place - follow steps 1-5 above.

### To dial a stored number:

1. A or B - press **A** or **B** when the handset is not in use. The phone dials the stored number. (Or you can press **TALK**, then press **A** for the same result).
2. 1-0 - press **TALK**, press **MEM**, press **1** (or any other numeric button). The phone dials the stored number.

## XLC2 BOOST Function (Amplification)

### Amplify Incoming Sounds (Handset)

1. While on a call, press the **BOOST** button to engage the additional amplification (up to 50dB); the TALK button turns red.

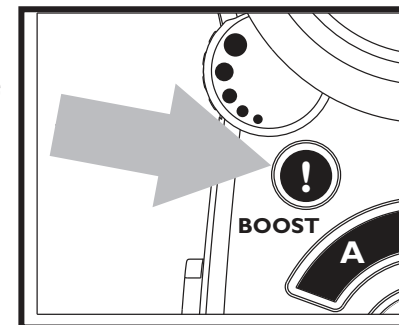

2. Adjust the **VOLUME** rotary control to achieve the desired sound level (up to 50dB of amplification).

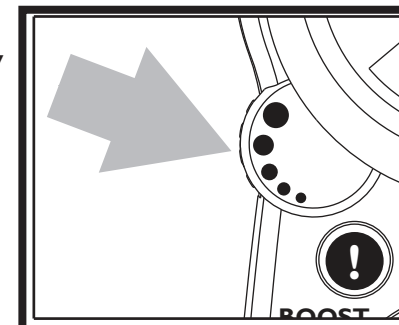

3. Adjusting the **TONE** switch allows you to customize your hearing experience. Since we all have different hearing preferences, we suggest exploring each setting to find the one most comfortable for you. The three available settings are:

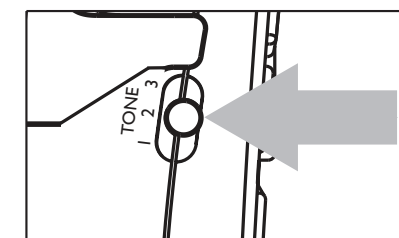

- 1 - Flat frequency response: best for hearing aid users;
- 2 - High frequency emphasis: best used to hear high frequency sounds;
- 3 - MBC (Multi-Band Compression): makes words clearer and easier to understand.

## XLC2 AUTO BOOST Function

On the back of the XLC2 base, there is an AUTO BOOST ON / OFF switch, to enable the Auto Boost Function.

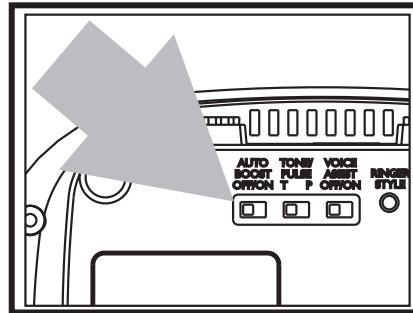

When this is set to “ON,” the Boost function is automatically enabled every time the phone is picked up - the call starts in Boost ON mode.

When the Auto Boost Override switch is set to “OFF” (default setting), the Boost function turns off after the phone is hung up - the call starts in Boost OFF mode.

Setting this switch to “ON” is recommended if all of the users of the telephone need the additional amplification. Setting this switch to “OFF” is useful when people with varying hearing abilities use the phone.

During a call, pressing the BOOST button toggles the Boost function ON or OFF according to the user’s needs.

**WARNING: VOLUME MAY BE LOUD!**

## XLC2 Outgoing Speech Amplification (OSA)

This function amplifies the level of your voice, in case your voice is perceived as being too quiet by the other person on the call.

To enable this function, press and hold the **BOOST** button for three seconds. The phone beeps and the TALK button backlight turns orange to indicate that the function is active; the function can be enabled/disabled while on a phone call by pressing and holding the BOOST button until the beep is heard.

To return to the default setting for your voice volume level, press and hold the **BOOST** button again for three seconds. You will hear a beep confirming that the function is disabled. To verify, the phone’s TALK button should no longer be orange when you are on a call.

### NOTES:

**1. IMPORTANT:** In order to experience the best audio quality for both parties during a call, we recommend you turn on this function **only** if your voice is considered too quiet.

**2.** OSA is also available in speakerphone mode.

## XLC2 Troubleshooting

### NO DIAL TONE

- Verify the TALK Button is lit.
- Verify the AC adapter is securely plugged into the AC power outlet and the telephone.
- Verify the telephone line cord is securely plugged into the wall jack and the telephone.
- Make sure the handset batteries are fully charged.
- Verify the telephone is in the correct dialing mode, tone (touch) or pulse (rotary).
- Make sure you are in the usable range of the base station.
- You may have too many extensions on your line. Try unplugging a few devices.

### NO DIAL TONE, AND HANDSET VISUAL RINGER is blinking (twice every second)

It is possible that the handset has lost connection to the base.

- Make sure you are in the usable range of the base station.
- If you are close to the base, but you are still unable to get a dial tone, proceed as follows:
  1. Handset: press and hold the **FLASH** button for three seconds, until the keypad backlight and visual ringer start flashing; release the FLASH button.
  2. Base: press and hold the **FIND** button for three seconds, until the IN USE light and visual ringer (base) start flashing; release the FIND button.
  3. Wait for the connection to be re-established; the handset will beep five times to indicate successful registration.
  4. If the handset beeps just twice, the registration was not successful. Repeat steps 1-4 above.

## XLC2 Troubleshooting

### TALK button is blinking red (twice every 2 seconds)

Handset batteries are low on charge; return the handset to the base to recharge the batteries

### VISUAL RINGER is blinking red (twice every 5 seconds)

The handset is out of range, or the power to the base is unplugged; return the handset to the usable area, and check the power adapter connections on the base unit.

### TALK button is blinking green (fast pace) and VISUAL RINGER is backlit red

The base is trying to locate the handset; press **TALK** to end the FIND/paging process and return the handset to the base.

### RINGER does not work

- Make sure the RINGER button on the handset is set to ON, and the SILENT button on the base is not lit red yet.
- Make sure you are in the usable range of the base station.
- Make sure the handset batteries are fully charged.

### TALK button is backlit orange during a call

The OSA function is enabled - see page 23 for details.

The **TALK button lights up** as per the settings below:

- green when the phone is in use, non-Boost mode;
- red when the phone is in use, BOOST function is engaged;
- orange when the OSA function is active;
- blinks green during incoming ring or when the base is paging the handset (FIND function is engaged) - along with the visual ringer
- blinks green (slower) during the memory programming process

## XLC2 Troubleshooting

### Phone Will Not Hold Charge

- Make sure the charging contacts on the handset and base are free of dust and dirt.
- Clean the battery contact with a cloth moistened with alcohol.
- Make sure CHARGE LED on the base is lit when the handset is in the cradle. If necessary, replace the handset batteries. (See Battery Information.)

### Difficulty in Placing or Receiving Calls

- Check the visual ringer and/or other buttons for different blinking lighting patterns - see above examples.
- Make sure you have selected the correct dialing mode, tone or pulse.
- Disconnect the base for 5-10 seconds, then reconnect. Place the handset back on the base and reinsert the AC adapter.
- Make sure the handset batteries are fully charged.

### Unable To Access Automated Systems

Automated systems used by banks, long distance voicemail and other applications require that a phone be set to TONE dialing. Check the switch on the bottom of the phone labeled TONE / PULSE and set to **TONE**. This will enable the phone to be compatible with these automated systems.

### Poor Audio Quality

The base may be too close to electrical appliances, reinforced concrete walls or metal door frames. Place the base away from any electrical appliances.

## XLC2 Technical Information

**Amplified dB Level:** 50dB

### Dimensions

- Handset Size: 7.4" x 2.3" x 1.7" (H x W x D)
- Base Size: 5.3" x 4.5" x 3.6" (H x W x D)

### Weight

- Handset (no batteries): 6.35 oz.
- Base: 7 oz.
- Wall mount bracket: 1.16 oz.
- Batteries (handset only): 1.23 oz.

### Power Specifications

AC Adapter:

- Input: 100V-240V AC
- Output: 7.5VDC, 500 mA; Model T07505U002

Battery: 1.2V 600mAh Ni-MH, 60AAAHC, GPI International Ltd.

**Talk time:** 6.5 hours (handset batteries - 600mAh)

**Standby time:** 130 hours (handset batteries - 600mAh)

## XLC2 Regulatory Compliance

### Important Information for Customers

#### PART 68 OF FCC RULES INFORMATION

This equipment complies with Part 68 of the FCC rules and the requirements adopted by the ACTA. On the bottom of this equipment is a label that contains, among other information, a product identifier in the format US:AAAEQ##TXXXX. If requested, this number must be provided to the telephone company.

A plug and jack used to connect this equipment to the premises wiring and telephone network must comply with the applicable FCC Part 68 rules and requirements adopted by the ACTA. A compliant telephone cord and modular plug, RJ11 USOC, is provided with this product. It is designed to be connected to a compatible modular jack that is also compliant. See installation instructions for details.

The REN is used to determine the number of devices that may be connected to a telephone line. Excessive RENs on a telephone line may result in the devices not ringing in response to an incoming call. In most but not all areas, the sum of RENs should not exceed five (5.0). To be certain of the number of devices that may be connected to a line, as determined by the total RENs, contact the local telephone company. For products approved after July 23, 2001, the REN for this product is part of the product identifier that has the format US:AAAEQ##TXXXX. The digits represented by ## are the REN without a decimal point (e.g., 03 is a REN of 0.3). For earlier products, the REN is separately shown on the label.

## XLC2 Regulatory Compliance

If this telephone equipment causes harm to the telephone network, the telephone company will notify you in advance that temporary discontinuance of service may be required. But if advance notice isn't practical, the telephone company will notify the customer as soon as possible. Also, you will be advised of your right to file a complaint with the FCC if you believe it is necessary.

The telephone company may make changes in its facilities, equipment, operations or procedures that could affect the operation of the equipment. If this happens, the telephone company will provide advance notice in order for you to make necessary modifications to maintain uninterrupted service.

If trouble is experienced with this telephone equipment, for repair or warranty information, please contact Clarity, 800-426-3738. If the equipment is causing harm to the telephone network, the telephone company may request that you disconnect the equipment until the problem is resolved.

This telephone equipment is not intended to be repaired and it contains no repairable parts. Opening the equipment or any attempt to perform repairs will void the warranty. For service or repairs, call 800-426-3738.

Connection to party line service is subject to state tariffs.

Contact the state public utility commission, public service commission or corporation commission for information.

If your home has specially wired alarm equipment connected to the telephone line, ensure the installation of this telephone equipment does not disable your alarm equipment. If you have



## XLC2 Regulatory Compliance

questions about what will disable alarm equipment, consult your telephone company or a qualified installer.

This telephone equipment is hearing aid compatible.

To comply with state tariffs, the telephone company must be given notification prior to connection. In some states, the state public utility commission, public service commission or corporation commission must give prior approval of connection.

### PART 15 OF FCC RULES INFORMATION

This device complies with part 15 of the FCC Rules. Operation is subject to the following two conditions: (1) This device may not cause harmful interference, and (2) this device must accept any interference received, including interference that may cause undesired operation.

This equipment has been tested and found to comply with the limits of a Class B digital device, pursuant to Part 15 of FCC rules. These limits are designed to provide reasonable protection against harmful interference in residential installation.

This equipment generates, uses, and can radiate radio frequency energy and, if not installed and used in accordance with the instructions, may cause harmful interference to radio communications.

However, there is no guarantee that interference will not occur in a particular installation; if this equipment does cause harmful interference to radio or television reception, which can be determined by turning the equipment off and on, you are encouraged to try to correct the interference by one of the following measures:

## XLC2 Regulatory Compliance

1. Where it can be done safely, reorient the receiving television or radio antenna.
2. To the extent possible, relocate the television, radio or other receiver with respect to the telephone equipment. (This increases the separation between the telephone equipment and the receiver.)
3. Connect the telephone equipment into an outlet on a circuit different from that to which the television, radio, or other receiver is connected.
4. Consult the dealer or an experienced radio/TV technician for help.

Privacy of communications may not be ensured when using this phone.

**WARNING:** To maintain the compliance with the FCC's RF exposure guideline, place the base unit at least 20 cm from nearby persons.

For body worn operation, this handset has been tested and meets the FCC RF exposure guidelines when used with the Clarity and Plantronics accessories supplied or designated for this product. Use of other accessories may not ensure compliance with FCC RF exposure guidelines.

**WARNING:** Changes or modifications to this equipment not expressly approved by the party responsible for compliance could void the user's authority to operate the equipment.

**This product meets the applicable Industry Canada technical specifications.**

Before installing this equipment, users should ensure that it is permissible to be connected to the facilities of the local telecommunications company. The equipment must also be installed using an acceptable method of connection. In some

## XLC2 Regulatory Compliance

cases, the company's inside wiring associated with a single line individual service may be extended by means of a certified connector assembly (telephone extension cord).

The customer should be aware that compliance with the above conditions may not prevent degradation of service in some situations.

Repairs to certified equipment should be made by an authorized Canadian maintenance facility designated by the supplier. Any repairs or alterations made by the user to this equipment, or equipment malfunctions, may give the telecommunications company cause to request the user to disconnect the equipment.

Users should ensure for their own protection that the electrical ground connections of the power utility, telephone lines and internal metallic water pipe system, if present, are connected together. This precaution may be particularly important in rural areas.

**WARNING:** Users should not attempt to make such connections themselves, but should contact the appropriate electric inspection authority, or electrician, as appropriate.

The Ringer Equivalence Number is an indication of the maximum number of terminals allowed to be connected to a telephone interface. The termination on an interface may consist of any combination of devices subject only to the requirement that the sum of the Ringer Equivalence Numbers of all the devices does not exceed five.

This Class B digital apparatus complies with Canadian ICES-003.

[The term "IC:" before the certification/registration number only signifies that the Industry Canada technical specifications were met.]

## XLC2 Warranty

**Incidental or Consequential Damages:** Neither Clarity nor your retailer dealer or selling distributors has any responsibility for any incidental or consequential damages including without limitation, commercial loss or profit, or for any incidental expenses, expenses, loss of time, or inconvenience. Some states do not allow exclusion or limitation of incidental or consequential damage, so the above limitation or exclusion may not apply to you.

**Other Legal Rights:** This warranty gives you specific legal rights and you may also have other rights which vary from state to state.

To obtain warranty service, please prepay shipment and return the unit to the appropriate facility listed below.

### Clarity Service Center

4289 Bonny Oaks Drive  
Chattanooga, Tennessee 37406  
Tel: 423-629-3500 or 800-426-3738  
Fax: 423-622-7646 or 800-325-8871

### Plantronics Service Centre

151 Hymus  
Point Claire, Quebec H9R 1E9  
Tel: 800-540-8363 or 514-956-8363  
Fax: 514-956-1825

## XLC2 Warranty

Please use the original container, or pack the unit(s) in a sturdy carton with sufficient packing material to prevent damage. Include the following information:

**A proof-of-purchase** indicating:

- Model number and date of purchase;
- Bill-to address;
- Ship-to address;
- Number and description of units shipped;
- Name and telephone number of person to call, should contact be necessary;
- Reason for return and description of the problem.

Damage occurring during shipment is deemed the responsibility of the carrier, and claims should be made directly with the carrier.

The following warranty and service information applies only to products purchased and used in the U.S. and Canada. For warranty information in other countries, please contact your local retailer or distributor.

**Limited Warranty:** Clarity, a division of Plantronics, Inc. (“Clarity”) warrants to the original consumer purchaser that, except for limitations and exclusions set forth below, this product shall be free from defects in materials and workmanship for a period of one (1) year from the date of original purchase (“Warranty Period”). The obligation of Clarity

## XLC2 Warranty

under this warranty shall be at Clarity’s option, without charge, of any part or unit that proves to be defective in material or workmanship during the Warranty Period.

**Exclusions from Warranty:** This warranty applies only to defects in factory materials and factory workmanship. Any condition caused by accident, abuse, misuse or improper operation, violation of instructions furnished by Clarity, destruction or alteration, improper electrical voltages or currents, or repair or maintenance attempted by anyone other than Clarity or an authorized service center, is not a defect covered by this warranty. Telephone companies manufacture different types of equipment and Clarity does not warrant that its equipment is compatible with the equipment of a particular phone company.

**Implied Warranties:** Under state law, you may be entitled to the benefit of certain implied warranties. These implied warranties will continue in force only during the warranty period. Some states do allow limitations on how long an implied warranty lasts, so the above limitation may not apply to you.