

SUPER SMALL FULLY RECUMBENT BIKE

MODELS: SS101







"Motivating Kids to Move!"



Important Instructions

Please read these instructions carefully before using the equipment for the first time. They contain information which is important for your safety as well as for the use and maintenance of the unit. Keep these instructions in a safe place for reference purposes, to assist you when ordering spare parts, and maintenance work.

For Your Safety

-  ATTENTION! For indoor use only!
-  ATTENTION! This training device should be used only for its intended purpose.
-  ATTENTION! Any other use of the equipment is prohibited and may be dangerous. The manufacturer cannot be held liable for damage or injury caused by improper use of the equipment.
- Incorrect repairs and structural modifications may endanger the safety of the user.
- Worn or damaged parts should be replaced immediately and the equipment taken out of use until they have been repaired. Damaged components may endanger your safety or reduce the lifetime of the equipment.
- If the equipment is in regular use, check all its components thoroughly every 1-2 months. Pay particular attention to the tightness of bolts and nuts.
-  ATTENTION! Instruct children on possible sources of danger during exercising.
- Always wear suitable shoes when using exercise equipment.
- In choosing the location of the equipment, ensure it is a safe distance from any obstacles.
- The surface on which the unit is placed must be firm and even. Place rubber or straw mats under it to deaden any noise or impacts.

Handling the equipment

- It is not recommended to use or store the unit in a damp room as this may cause it to rust. Please ensure that no part of the machine comes in contact with liquids (drinks, perspiration, etc.). This may cause corrosion.
- Damaged components may endanger your safety or reduce the lifetime of the equipment. For this reason, worn or damaged parts should be replaced immediately and the equipment taken out of use until this has been done. Use only original Kidsfit spare parts.
- To ensure that the safety level is kept to the highest possible standard, determined by its construction, this product should be serviced regularly (once a year) by a qualified service tech.
- Please ensure that liquids or perspiration never enter the machine or the electronics.
- Before beginning your first training session, familiarize yourself thoroughly with all the functions and settings of the unit.
- When choosing a place for the equipment please ensure that the floor can withstand the additional weight/ load.

Proper Procedures for Use:

1. Safely position child on the seat with hands firmly grasping the safety side handles.
2. Insert feet into the foot pedals.
3. Slowly begin pedaling until a comfortable pace is reached.
4. Before exiting the bike, make sure the user has come to a complete stop.
5. Have child safely exit the machine.

Seat Adjustment



In order to adjust the seat for different users heights, Pull the purple knob towards you and push the seat upward or downward depending on the length needed for the user 's legs.

Parts and Power Input



CARDIO KIDS FULLY RECUMBENT BIKE MODELS: SS101 MAINTENANCE SHEET

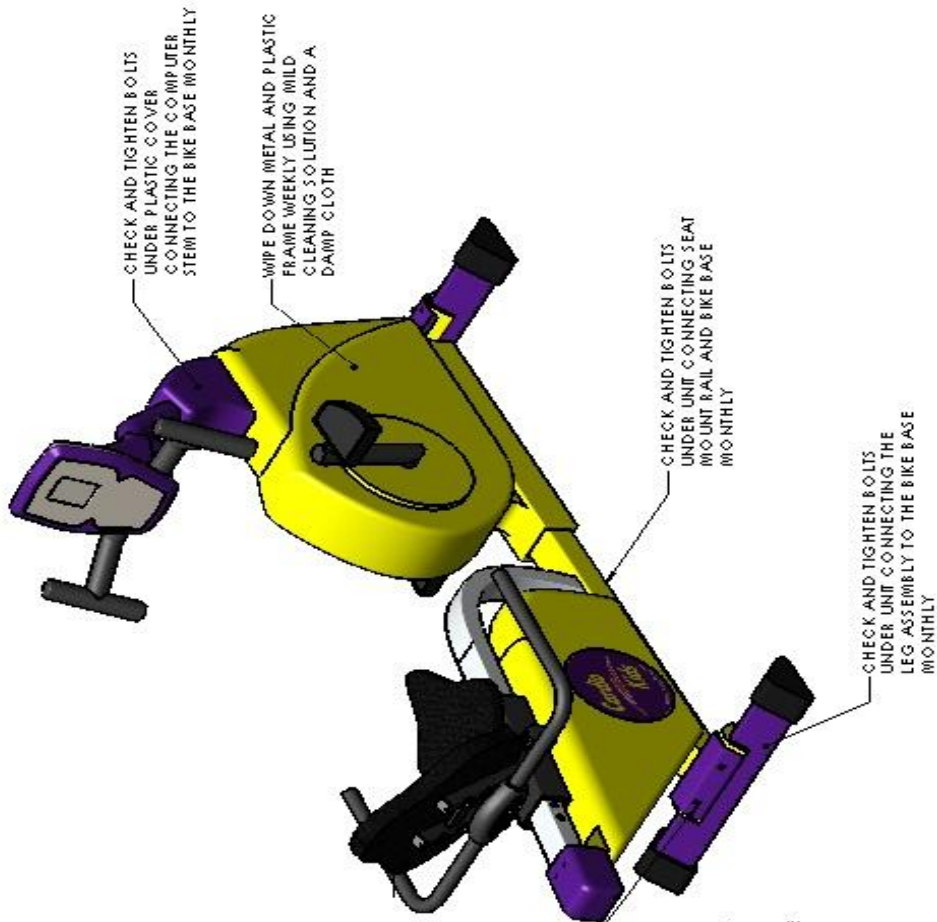

CHECK AND TIGHTEN THE 12 BOLTS CONNECTING THE SEAT PADS AND PULSE SENSOR HANDLE MONTHLY

CHECK AND TIGHTEN BOLTS CONNECTING THE PLASTIC FOOT COVER TO THE BIKE BASE MONTHLY

CHECK AND TIGHTEN BOLTS UNDER UNIT CONNECTING SEAT TO UNIT RAIL AND BIKE BASE MONTHLY

CHECK AND TIGHTEN BOLTS UNDER UNIT CONNECTING THE LEG ASSEMBLY TO THE BIKE BASE MONTHLY

CHECK AND TIGHTEN BOLTS UNDER PLASTIC COVER CONNECTING THE COMPUTER STEM TO THE BIKE BASE MONTHLY

WIPE DOWN METAL AND PLASTIC FRAME WEEKLY USING MILD CLEANING SOLUTION AND A DAMP CLOTH

- IT IS NOT RECOMMENDED TO USE OR STORE THE UNIT IN A DAMP ROOM AS THIS MAY CAUSE IT TO RUST. PLEASE ENSURE THAT NO PART OF THE MACHINE COMES IN CONTACT WITH LIQUIDS (DRINKS, PERSPIRATION, ETC.). THIS MAY CAUSE CORROSION.
- DAMAGED COMPONENTS MAY ENDANGER YOUR SAFETY OR REDUCE THE LIFETIME OF THE EQUIPMENT. FOR THIS REASON, WORN OR DAMAGED PARTS SHOULD BE REPLACED IMMEDIATELY AND THE EQUIPMENT TAKEN OUT OF USE UNTIL THIS HAS BEEN DONE. USE ONLY ORIGINAL KIDSFIT SPARE PARTS.
- TO ENSURE THAT THE SAFETY LEVEL IS KEPT TO THE HIGHEST POSSIBLE STANDARD, DETERMINED BY ITS CONSTRUCTION, THE PRODUCT SHOULD BE SERVICED REGULARLY (ONCE A YEAR) BY A QUALIFIED SERVICE TECH.

Replacement Parts List

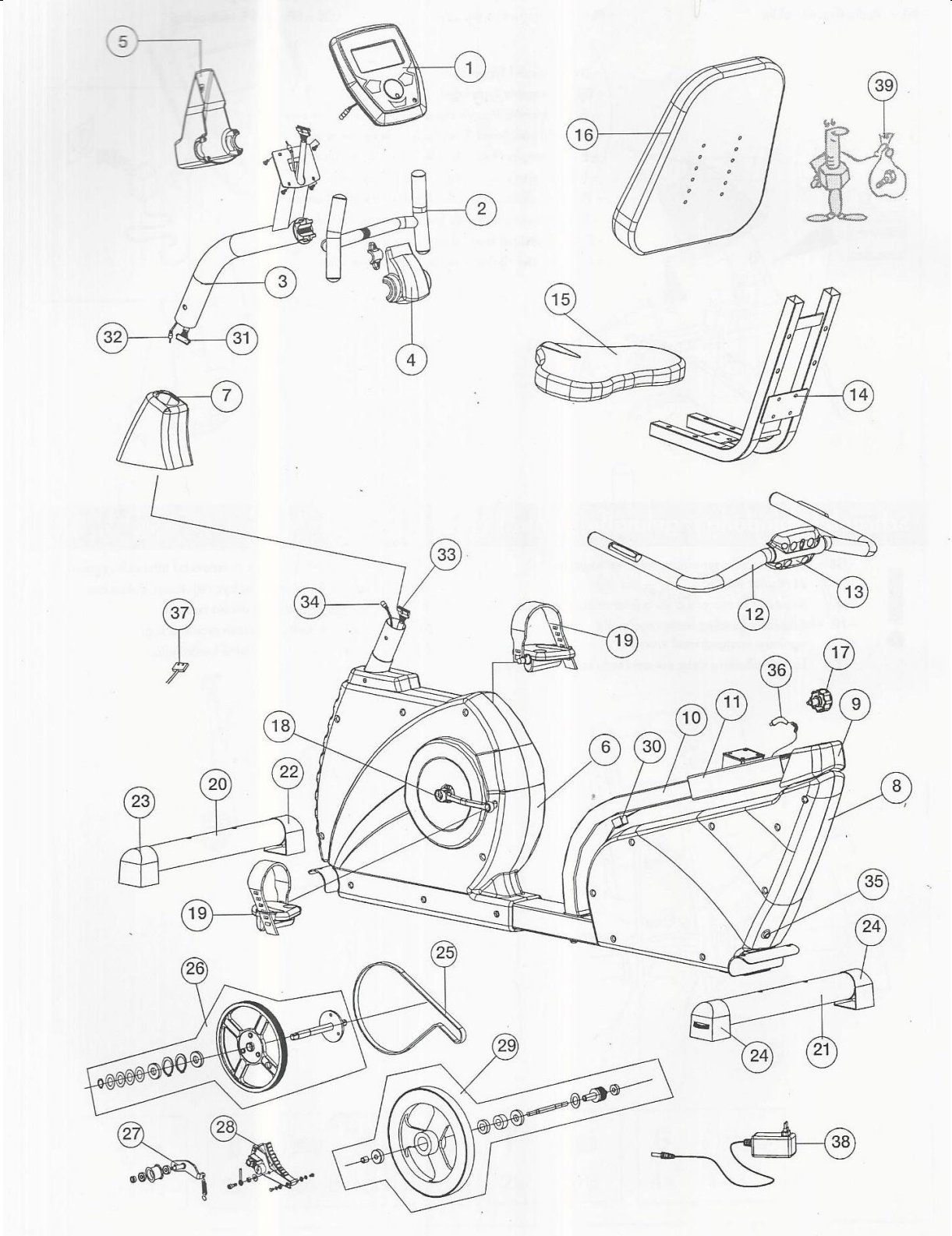

****Please include the Model Number and Part Number when requesting replacement parts.**

07986-996			07986-996		
①	1x	68003469	②①	1x	68003533
②	1x	68003821	②②	1x	68003072
③	1x	68003822	②③	1x	68003073
④	1x	68003969	②④	2x	60883074
⑤	1x	68003968	②⑤	1x	68008302
⑥	1x	68003970	②⑥	1x	68003610
⑦	1x	68003967	②⑦	1x	68008301
⑧	1x	68003971	②⑧	1x	68008303
⑨	1x	68003972	②⑨	1x	68003540
⑩	1x	68003833	③⑩	1x	68003842
⑪	1x	68003834	③⑪	1x	68003843
⑫	1x	68003835	③⑫	1x	68003844
⑬	1x	68003973	③⑬	1x	68003845
⑭	1x	68003837	③⑭	1x	68003846
⑮	1x	68003838	③⑮	1x	68003847
⑯	1x	68003839	③⑯	1x	68003848
⑰	1x	68003517	③⑰	1x	68003849
⑱	1x	68003525	③⑱	1x	68003170
⑲	1x	68003504	③⑲	1x	68003851
⑳	1x	68003532			

Programming Computer

Brief description

The machine is equipped with a functional area with buttons and a display area (display) with variable symbols and graphics.

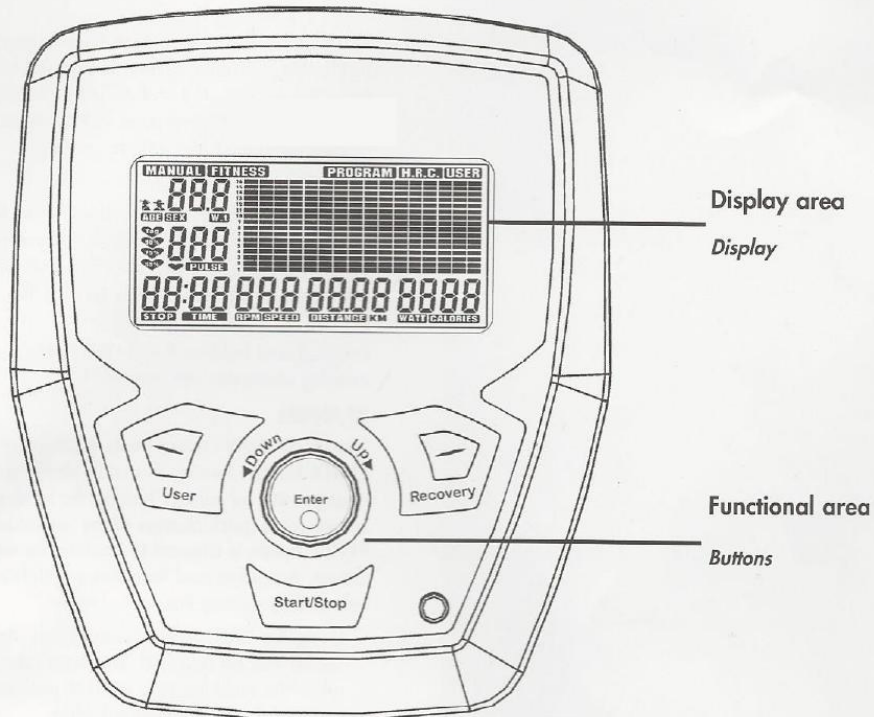

The electronics have the following functions:

- Personal user settings can be saved on a long-term basis
U1 – U4; gender, age, weight
- Monitoring with visual and audible signals
Age-related maximum pulse, target heart rate
- Display of fitness level between 1 and 6 calculated from the recovery heart rate after 1 minute
- Training program with individual or preset options for
fitness, endurance, strength or target heart rate training
- Motor-controlled brake stage adjustment
- Calculation of energy consumption according to the brake stage and pedaling frequency
- Selection of the speed and distance display [KM/H or M/H]
- Selection of the temperature display [°C or °F]
- Pre-installed pulse receiver for the T34 POLAR chest strap.

Training and operating instructions

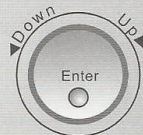
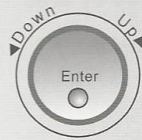
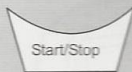
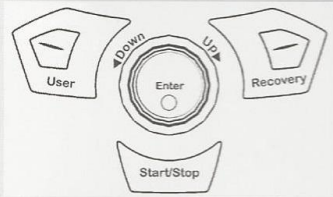

Brief instructions

Functional area

The buttons are briefly explained below.

The correct use of these buttons is explained in the individual chapters. The names of the functional buttons are also used in these descriptions as follows:

START / STOP

This button starts the workout. By pressing this button again, the computer counter is stopped and the settings can be adjusted. If the START button is then pressed again, the computer will continue to count according to the new settings.

ENTER

The ENTER button is combined with the UP/DOWN control knob. The ENTER button is pressed to confirm the settings, menus, programs and functions which have been selected by turning the control knob.

Pressing and holding the ENTER button restarts the training computer, see chapter 1.

UP/DOWN

The UP/DOWN control knob is combined with the ENTER button. Turning this knob slowly gradually changes the set values. Turning the knob quickly allows for a quick change of the set values. The ENTER button is pressed to confirm the settings, menus, programs and functions which have been selected by turning the control knob.

- Using the UP/DOWN control knob, default values can be adjusted. This must take place when the machine is in a STOP position > the bottom left STOP button will blink
- During training, this control knob can be used to increase or decrease the overall intensity level > graphical bar chart.
- The desired user settings are preselected using the UP or DOWN control knob (USER U1-U0).
- The selection of a training program (MANUAL, PROGRAM, USER or H.R.C.) is also carried out using the UP or DOWN control knob.
- After selecting and confirming a training program, the further parameter settings for this training program are also set and confirmed using the UP/DOWN control knob: TIME, DISTANCE, CALORIES or PULSE.

UP Upwards adjustment of default values.

By turning the control knob to the right (UP), you can increase the set value.

DOWN Downwards adjustment of default values.

By turning the control knob to the left (DOWN), you can decrease the set value.

User presetting (U1 / U2 / U3 / U4 / U0)

Using the USER button, the desired or preset user can be selected.

If the machine has to be disconnected from the mains and reconnected for e.g. due to a change in location, the input personal user data will be retained when the machine is restarted (U1 to U4).

U0 can be selected for a guest user.

IMPORTANT! No training data is saved using this USER setting (TIME, DISTANCE and CALORIES)! This data is only counted during a training session.

RECOVERY

The RECOVERY button can be used to activate the recovery heart rate measurement after your training session.

Heart rate measurement

The heart rate measurement can be taken in 3 ways:

1. Hand pulse sensor (standard)
2. Ear clip (optional)
The plug is connected to a socket in the machine.
3. Chest strap without receiver (optional)
The receiver is built into this electronic unit behind the display. If an ear clip is plugged in, this must be removed. The POLAR T34 chest strap without a plug-in receiver is available as an accessory (Item no. 67002000).

Display functions

General

The display is divided into four separate display areas

1. The top row displays information on the status or selected training program
2. The top left zone gives information on the current user (U0-4) and user-specific data is recorded: gender, age and weight.

Using this input data, the computer calculates data relating to heart rate and the level of intensity during training.

3. The large screen which displays a graphic image of the training distance (course profile) offers simple user guidance during the training session.
One bar = low intensity; 16 bars above one another = maximum intensity.
4. Below the user display and in the entire bottom row of the screen, there are several adjacent symbols where the different target values and training units are displayed. When presetting these units, the functional symbol will blink > e.g. TIME.

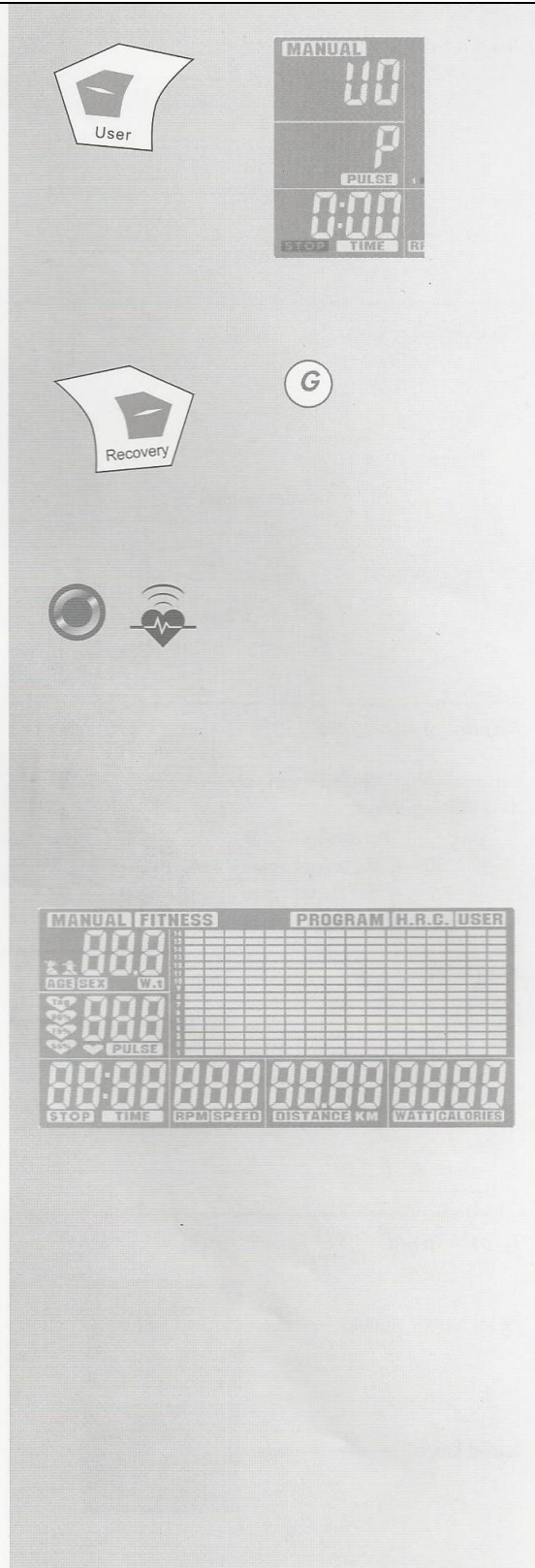

Training and operating instructions

Training program

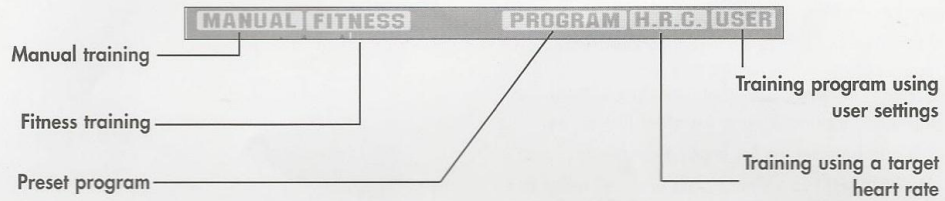

Personal user data

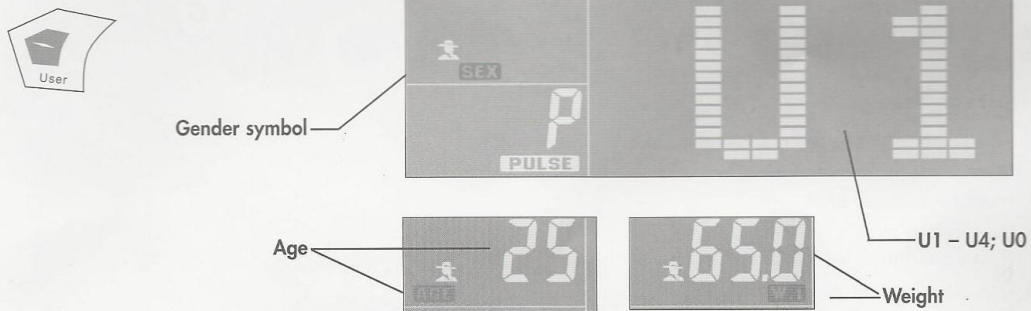

Display of heart rate

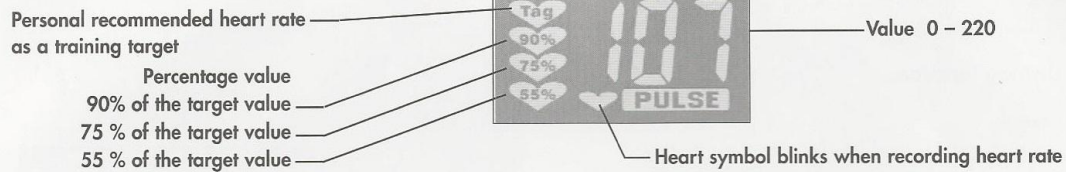

Time / training time / start - stop

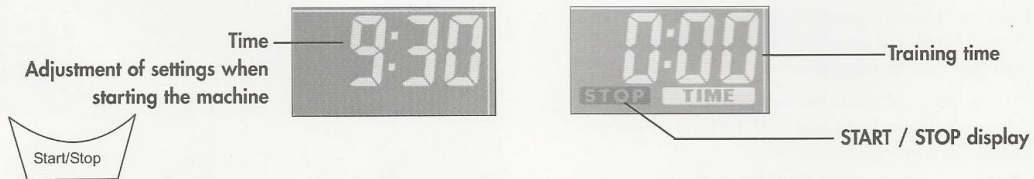

Turns / speed

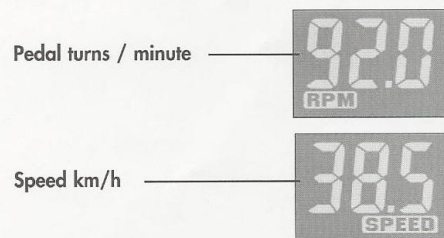

Distance / temperature

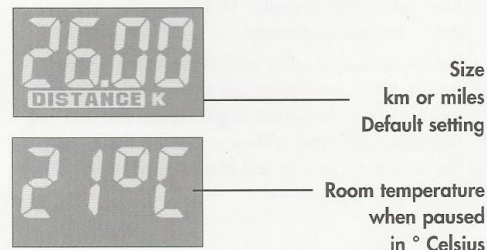

76

Energy consumption

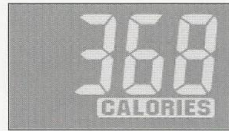

Calories burnt

Bar chart



Intensity profile
1 point (height) = 1 level
1 row = level 1

Intensity display

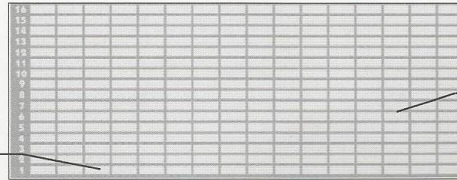

16 columns

1 column corresponds to 1
minute for cross-trainers:
200 m or 0.1 miles
For exercise bikes: 400 m or
0.2 miles

Quick start (for beginners)

You can start training without previous experience. The different information will then be displayed on the screen. For an effective training session and to adjust your personal training settings, please read and follow these operating instructions.

Please also read the general information in the training instructions.

Setting the time:

After first switching on or reconnecting the machine to the mains, the time window will be displayed on the bottom left of the screen with setting options for hours and minutes.

The time can be changed using the UP/DOWN control knob: First move the hours UP/DOWN and confirm by pressing ENTER, then repeat to set the minutes and confirm the selected time by pressing the ENTER button.

If the machine is restarted by pressing and holding the ENTER button, the set time will be maintained as normal. By pressing the ENTER button twice (confirming the time) you will have further selection options.

The user display will then appear (U 1-0) U = USER. By pressing the USER button you can opt for a quick start U 0 > guest user.

Press the START button and start training.

You can finish your workout by stopping and pressing the STOP button. The training values achieved will then be displayed.



Training and operating instructions

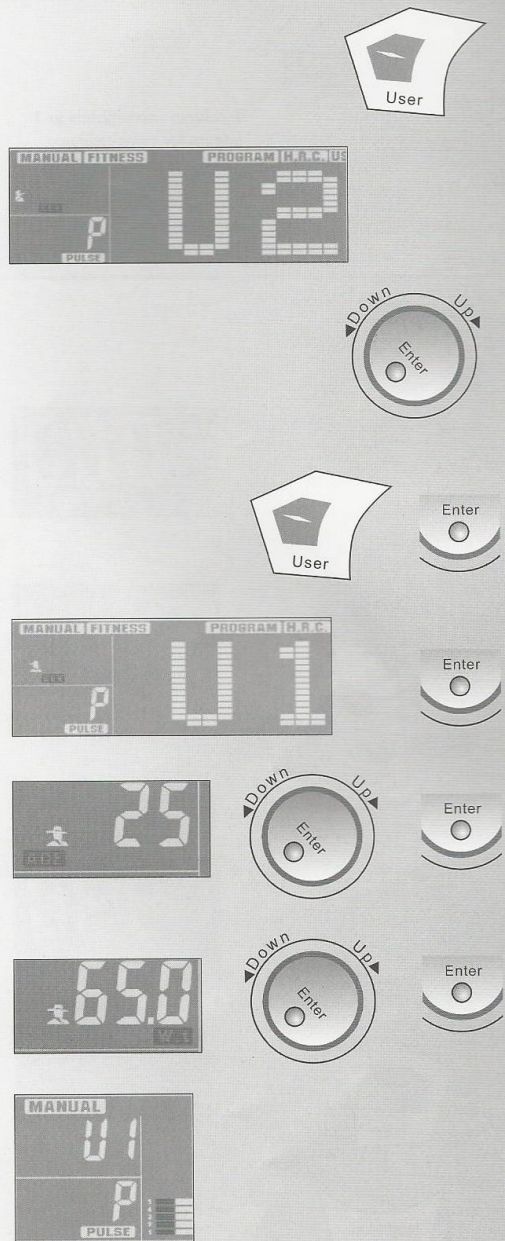

Individual presets

User presetting (U1 / U2 / U3 / U4 / U0)

The personal data can be saved for up to four different users and recalled when restarting the machine. The individual training program can therefore be used by four different people over a long period of time using their personal saved data.

The personal data is recalled and includes: gender, age and weight.

Guest user = U 0.

With the USER button, the desired or preset user can be selected. In the user field (top left) U1 will blink; if you press this again > U2 will appear; continue to press until reaching U 0.

If you do not wish to change your preset personal data, turn the UP/DOWN control knob. This will take you directly to the program selection in the upper part of the display.

If, after selecting a user (e.g. U1) you press the control knob once (ENTER), you will be able to enter or change your personal data > gender, age and weight. U1 is located at the right of the large display screen. In the user display (top left) the symbol SEX (gender) will blink and a male or female symbol can be selected. Adjusting these settings once again takes place by turning the control knob UP/DOWN, until the desired value or symbol is displayed and confirmed by pressing the ENTER button > press the control knob once. Example: male (symbol + SEX); 25 (AGE); 65 (WEIGHT).

By pressing the ENTER button once again, this will allow you to set your training program.

If the machine is disconnected from the mains or reconnected for e.g. due to a change in location, the input user data (U1 to U4) will be retained when restarting.

U 0 can be selected as a guest user. For training, it is not possible to input personal data such as gender, age and weight and this data is therefore not saved. Only the training functions MANUAL and PROGRAM may be accessed by the guest user.

IMPORTANT! In the user setting (U1 to U4), only personal data is saved, not training data such as TIME, DISTANCE and CALORIES.

Training program (top display row)

The different training programs are selected with the UP/DOWN control knob and confirmed by pressing ENTER.

Detailed information is explained under "Setting the training program". The differences in programs are defined as follows:

MANUAL Manual Training

This setting is selected for an individual training session, in which the individual functions are set manually [TIME, DISTANCE, CALORIES and PULSE].

The course profile remains linear and runs from left to right over the set timeframe. The resistance level can be increased or decreased using the UP/DOWN control knob during the training.

FITNESS preset program for fitness training

This program setting has a fixed time and intensity setting and can not be changed. At the end of the training session the program gives an analysis of training success using the calculated pulse data. This is displayed analogously to the recovery setting with F1 corresponding to the best score and F6 the worst.

PROGRAM preset training program

There are 12 fixed training program settings available. Using the course profile you can see the level of difficulty for each setting.

H.R.C. Training using a target heart rate (THR)

In this program setting, the intensity is set according to the preset heart rate. It is therefore necessary that the heart rate is recorded during training.

See > Pulse recording options.

The program offers 3 preset target values: 55, 75 and 90% of the heart rate.

Heart rate = 220 minus your age.

A further variable target value is also possible: "day"

You can personally define the target value using this setting. When reaching the set heart rate during the training session, the machine will emit a signal.

USER training program with user settings

This program allows for an individual adjustment of the course profile. At least one default value must be selected. > [TIME, DISTANCE, CALORIES or PULSE].

After selecting and setting the training program, you can view the target values by pressing the ENTER button.

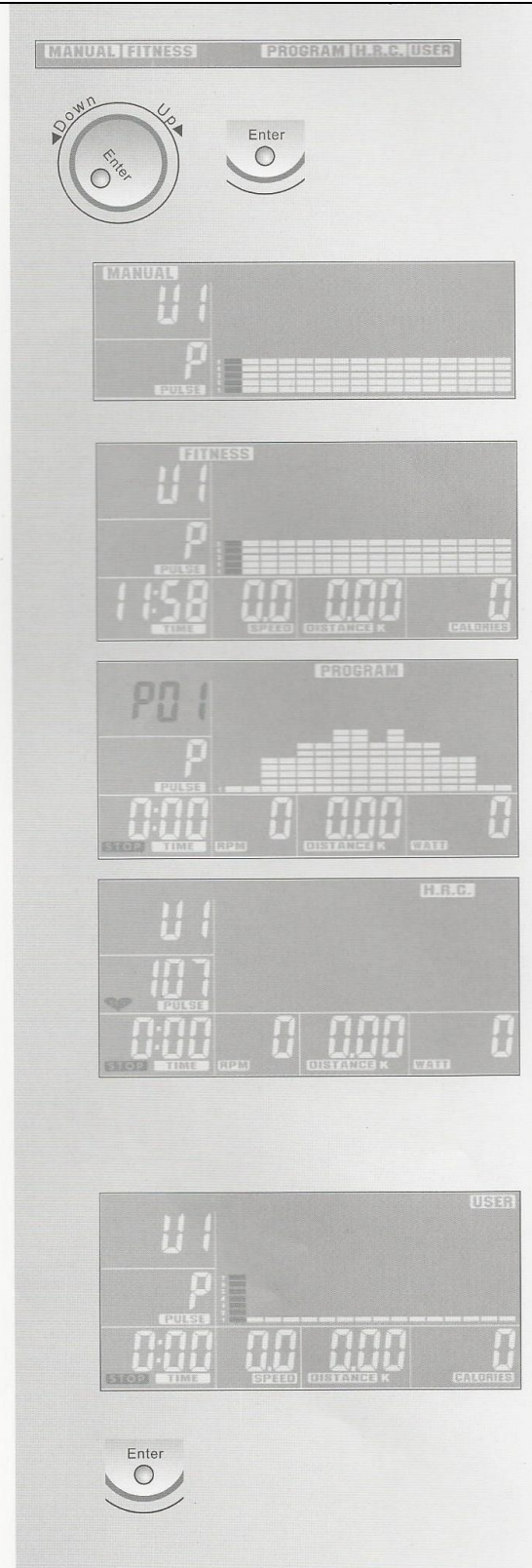

Training and operating instructions

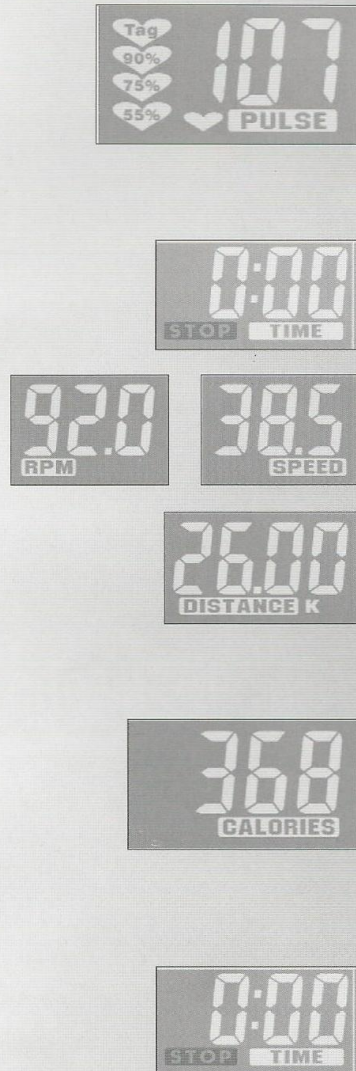

Target values and training units

In the bottom display row, there are several segment symbols displayed with the different target values and training units.

PULSE Pulse / Heart rate

If the pulse is recorded during the training session, the heart symbol will blink in this segment and the pulse value will be displayed as heart beats per minute. Display area: min. 30 to a max. 240.

Once the target pulse value has been achieved during the training session, the computer will emit an alarm signal.

TIME Training time

The training time is measured in minutes and seconds in this display. Display area: min. 00:00 to a max. 99:00

RPM /SPEED Speed

In this display area, the RPM (Rounds per minute) and SPEED are displayed in km/h at 6 second intervals. Display area: min. 0.0 to max. 99.9 km/h

DISTANCE Training course

The distance covered is measured in km. The calculation of distance covered begins at >0< and can be displayed to a maximum of 99.99 km. This calculation takes place at distances of 0.01 km = 10 metres.

CALORIES Calories burnt, energy consumption

In this display, the calculated number of burnt calories is displayed. The value is determined in training using the resistance and time measurements. Display area: min. 0 to a max. of 990. However, the data merely serves as a rough estimate by comparison to the different exercises and can not be used for medical purposes.

Personal training settings

General

- Without configuring particular presets, the values for the individual settings [TIME; DISTANCE, CALORIES and PULSE] are counted upwards from >0<.
- The set target values for TIME; DISTANCE, CALORIES and PULSE are retained every time the machine is restarted and are counted down to >0< during the workout. However, these target values can be reset at any time.
- For a meaningful workout, it is sufficient to enter just one target value for one setting [TIME; DISTANCE, CALORIES or PULSE].
- If a personal target value is set as a training value, the computer will begin counting down from this value. When the target value has reached >0< a signal will sound. If the workout is continued without setting a new target value, the

computer will begin counting down from the preset value in this mode after pressing the START button.

- Once target values have been set, the workout can not be changed unless the STOP button is pressed.

Target values

The setting of target values is the same for all default settings:

e.g. DISTANCE

1. Press the ENTER button until the >DISTANCE< symbol blinks in the display area.
2. By turning the control knob in an UPWARDS direction you can increase the value, e.g. increase the DISTANCE in stages of 0.1 km.
3. If you would like to further reduce the target value, you must turn the knob DOWNWARDS. The computer will continue to count down from the previous value.
4. Once you have set the target value, press the ENTER button. The value is then saved in this function and this will take you to the next function e.g. CALORIES.
5. If possible, only one default value should be entered. Otherwise the training targets will overlap for e.g. if you would like to reach the preset target value before the preset course target.
6. The other default values [TIME, CALORIES or PULSE] are also entered using the UP, DOWN and ENTER buttons as described under points 1-4.

After entering all default values, press the START button and begin your workout.

During the training session, all current values can be read beside one another. The preset value is counted down to >0<.

SLEEP MODE

If no RPM or PULSE values are recorded or no manual settings are carried out within 4 minutes, the machine will switch to sleep mode. The time and room temperature are displayed in the TIME and DISTANCE segments respectively. After a few seconds, the machine will switch to energy-saving mode meaning that the values will only be faintly visible.



Training and operating instructions

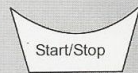
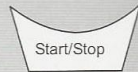

Stop or pause training.

- If training is paused and no further settings are adjusted, the time will continue (TIME). Upon resuming the workout the other units will also continue to be counted (DISTANCE, CALORIES and PULSE).
- If the workout is stopped using the STOP button and there is no further setting input, the time counter is also stopped. After pressing the START button and resuming the workout all units (TIME, DISTANCE, CALORIES and PULSE) will continue to be counted.
- If the workout is stopped using the STOP button and there is a change of user, program or target value selection, all units (TIME, DISTANCE, CALORIES and PULSE) will then begin counting from the standard start value. **IMPORTANT!** In this case, the previous training values are not saved!
- If the machine is removed from the mains or reconnected e.g. due to a change of location, all units will be counted (TIME, DISTANCE, CALORIES and PULSE) from the standard start value. **IMPORTANT!** In this case, the previous training values are not saved!

Training

Setting the training program

After switching on the machine and selecting a user (U 0-4) the program field in the upper display area will blink.

When training is stopped using the STOP button, you will be taken directly to the program field in the upper display area.

- Select the training program (MANUAL, PROGRAM, H.R.C. or USER) with the control knob and confirm by pressing ENTER.
- If the training mode that you have selected is MANUAL, PROGRAM or USER, and you preset a target heart rate value, the computer will emit a visual and audible alarm, as soon as the heart rate value has reached the target value.

Training > MANUAL Manual Training

The course profile is displayed in one smooth line. All default settings can be set individually: [TIME, DISTANCE, CALORIES or PULSE]

Start the workout by pressing the START button and active training.

By using the UP/DOWN control knob, the entire course profile can be increased or decreased before or during the workout.

During the set training time (TIME), the computer counts from left to right in the course profile (bar graph) with the blinking bars indicating training progress. Once the preset value [TIME, DISTANCE, CALORIES or PULSE] has been reached, an audible signal will sound for 8 seconds. No further training data will be counted. You have reached the training target! By pressing the START button and without changing the target value, you can repeat the workout session.

FITNESS Preset program for fitness training

This program setting has a fixed time and intensity setting and can not be changed. For this type of workout, the time (TIME) will count downwards from 12 minutes to 0.

The program intensity setting is consistent (5 bars), and the intensity setting can not be moved upwards or downwards in this training mode. The computer will calculate a fitness score on the basis of the target (DISTANCE), (RPM/SPEED) and (CALORIES).

If training is paused for more than 4 seconds or if the STOP button is pressed, counting is stopped and the fitness score is displayed. After this time, counting can not be resumed but only restarted using the START button with the target value of 12 minutes.

MANUAL FITNESS PROGRAM H.R.C. USER

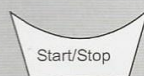
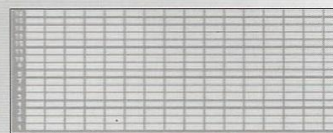
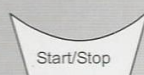
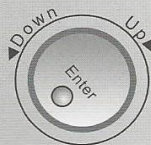

26.00
DISTANCE K

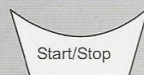
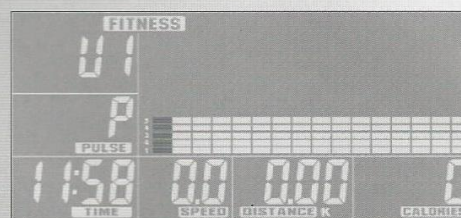

Training and operating instructions

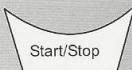
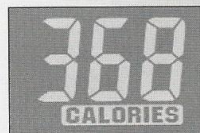
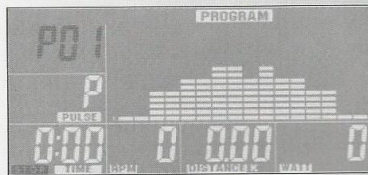
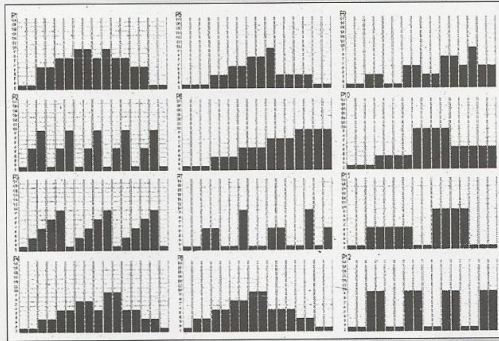
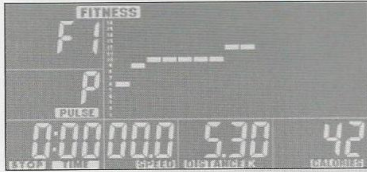

At the end of the 12 minute workout, the program will give an evaluation of training success using the calculated pulse data. This is displayed analogously to the recovery setting with F1 corresponding to the best and F6 the worst score respectively.

If the fitness score F1 is achieved in less than 12 minutes, the program will automatically stop the workout session.

Training > PROGRAM

Preset programs for your training

In the training enter PROGRAM you can select one of 12 different factory-pre-set training programs:

By turning the turning knob upwards or downwards, you can move from one program to the next. The alternating display shows the program number (P1-12) for about 1 second and then the route profile in blinking form. Via the ENTER key you confirm your selection, or select another program via UP and/or DOWN.

If you have selected your program, you can additionally enter a default value [TIME, DISTANCE, CALORIES or PULSE].

Press the ENTER key to reach the respective next setting possibility. Training start by pressing the START key and active training.

Via the UP and DOWN turning knob, the entire route profile can be increased or reduced either prior to the start of or during the training. By means of the set training period (TIME), the computer counts the training progress in the route profile (bar graph from left to right with a blinking bar. If the pre-set value [TIME, DISTANCE, CALORIES or PULSE] is reached, an acoustic signal will sound for 8 seconds. The training data is not counted further. You have reached your training target! By pressing the START key, it is also possible to continue your training.

Training > H.R.C.

Training via target heart rate (THR)

In this training mode the route profile is automatically adapted to the user's input values (U 1-4) as well as the measured heart rate.

If you have selected the training mode H.R.C. using the keys START/STOP, UP/DOWN and ENTER, the bottom heart symbol will blink in the PULSE segment with the value 55%. You can select 55, 75 or 90 % using the turning knob and set the individual target heart rate "date".

The percentage defaults 55%, 75% and 90% refer to the maximum pulse rate (220 - age) and pre-determine 3 general training intensities for the fitness training.

- 55% of the max. heart rate (220 - age) corresponds to the starting phase of the general fat burning trainings. This default can then also be increased manually to 65%.
- 75% of the max. heart rate (220 - age) corresponds to the phase for a general fitness training.
- 90% of the max. heart rate (220 - age) is only suited for shorter sub-maximum exertion intervals for performance increase in interval training.
- The setting "Tag" allows you to enter an individual pulse value as your training target. If this set value is exceeded, a signal will sound.

In this training mode it is not possible to set an additional PULSE value. All other default values can be set as desired. [TIME, DISTANCE or CALORIES]
After selecting your THR value, confirm it via ENTER. You then reach the default setting.

In this training enter it is not possible to set a PULSE value. All other default values can be set freely. [TIME, DISTANCE or CALORIES]

Training start by pressing the START key and active training.

- The computer compares your currently measured heart rate with the pre-set target value and accordingly adapts the braking level during your training.
- If the current heart rate is lower than the target value, the braking level will be increased by one step every 30 seconds, until the maximum value of the resistance or the set heart rate is reached.
- If the current heart rate is above the target value, the braking level is automatically reduced. It will be reduced by one step every 15 seconds until the set heart rate is reached.

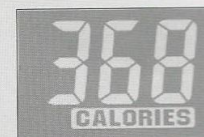
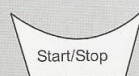
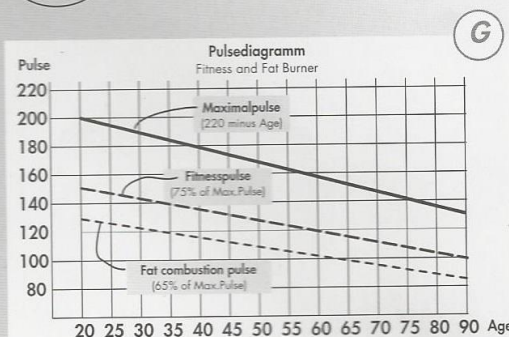
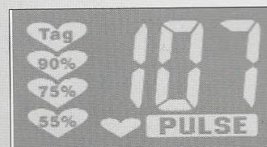

Training and operating instructions

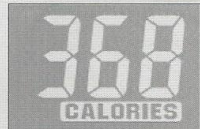
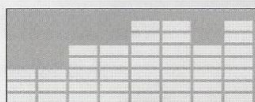
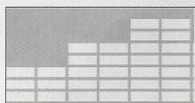
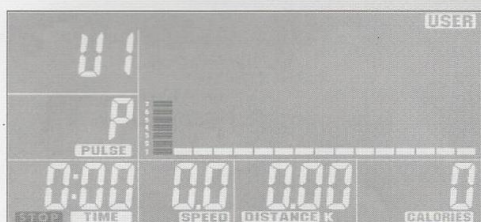
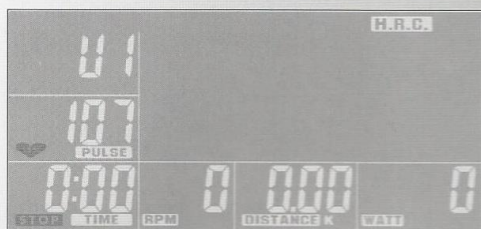

- If the brake stage is reduced to 1 but the heart rate value remains higher than the target value for one minute, the computer will stop and an audible alarm signal will sound as a warning. Reduce the workout intensity or stop the workout session. It is imperative that medical safety recommendations are followed!
- Over the set training period [TIME] the computer counts the training progress in the route profile (bar graph) from left to right with a blinking bar.
- If the pre-set value [TIME, DISTANCE or CALORIES] is reached, an acoustic signal will sound for 8 seconds. The training data is not counted further. You have reached your training target! By pressing the START key, it is also possible to continue your training.

Training > USER

Training program using the user setting

This training mode has no connection with the user setting (U1 - U0) when starting the machine!

In the training enter USER you can design your individual route profile.

The setting is made via the turning knob UP / DOWN in order to adjust the profile height. You reach the next bar via the ENTER key; then UP or DOWN again for height, etc. Program all 16 bars. Training start by pressing the START key and active training.

If you have designed your individual route profile, you can additionally set the default values. To this end, press the START STOP key. To this end, press and hold the ENTER key for 2 seconds. The TIME segment is blinking. Turn the UP / DOWN knob to enter any training time value (TIME), then confirm with ENTER. You will thus reach the distance setting (DISTANCE), etc.

All default values can be set individually [TIME, DISTANCE, CALORIES or PULSE]. At least one default value must be selected. After completing the setting of the default values, you can start your training by pressing the START key and start your active training.

The entire route profile can be increased or reduced via the UP and DOWN keys either prior to the start of or during the training.

By means of the set training period (TIME), the computer counts the training progress in the route profile (bar graph from left to right with a blinking bar. If the pre-set value [TIME, DISTANCE, CALORIES or PULSE] is reached, an acoustic signal will sound for 8 seconds. The training data is not counted further. You have reached your training target! By pressing the START key, it is also possible to continue your training.

RECOVERY Recovery heart rate phase

The RECOVERY function can be used after every training program.

Using the RECOVERY button, a measurement of the recovery heart rate can be taken at the end of the workout. The difference between the start and end heart rate per minute is calculated and a fitness score is determined. For regular training, the improvement of this score is a measure of increasing levels of fitness.

If the target values are reached, finish the workout, press the RECOVERY button and then place your hands on the hand pulse sensors. For a previous pulse measurement, 00:60 appears in the time display and the current pulse value blinks in the PULSE symbol. The time begins to count down from 00:60. Place your hands on the hand pulse sensors until reaching >0<. In the user display screen, a value between F1 and F6 will be displayed with being F1 the best and F6 the worst level. The line in the bar chart shows the pulse course during the measurement time. Press the RECOVERY button once again to end the function.

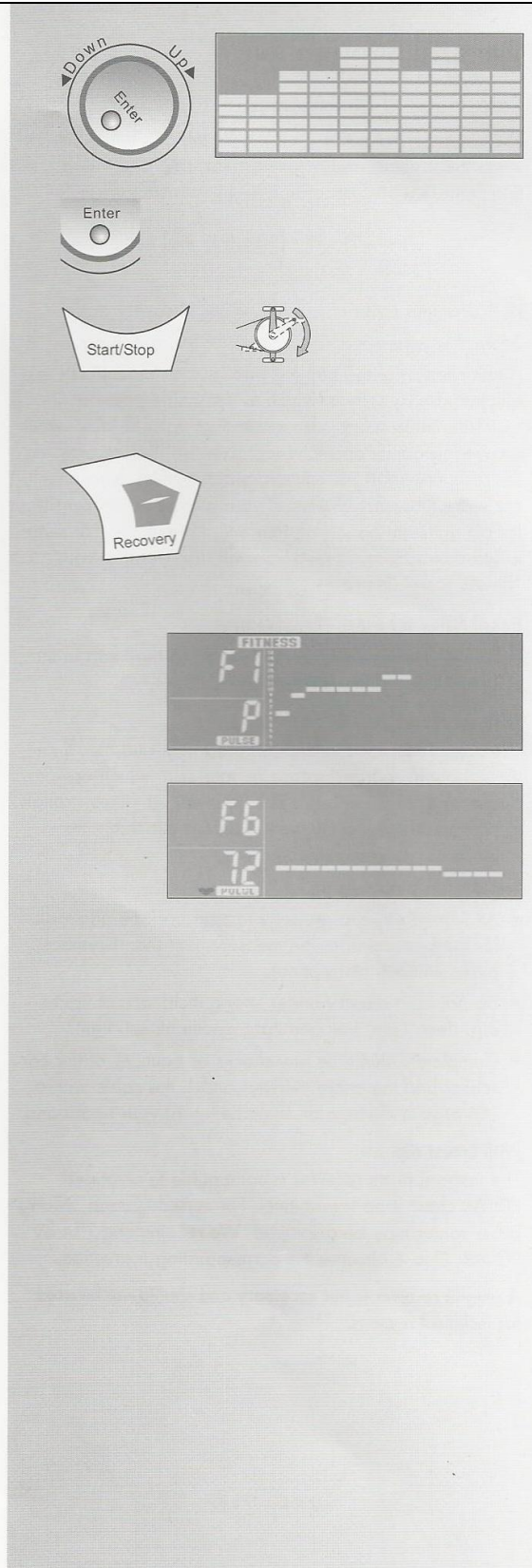

Training and operating instructions

General information

Calculation of fitness score

The computer calculates and assess the difference between the training and recovery heart rate and the resulting "fitness score" according to the following formula:

$$\text{Note (F)} = 6 - \frac{(10 \times (P1 - P2))^2}{P1}$$

P1 = Training pulse

P2 = Recovery pulse

Score 1 = very good

Score 6 = poor

A comparison of the training and recovery heart rate is a quick and easy way in which to determine physical fitness. The fitness score is an orientation value to assess your recovering ability after physical exercise. Before pressing the recovery heart rate button and determining your fitness score, you should train at your own level of intensity for a significant period of time e.g. 10 minutes. For regular cardiovascular training you will discover that your "fitness score" improves.

Possibilities for Pulse Measurement

The pulse measurement starts as soon as the heart in the display blinks in time with your pulse beat.

With ear clip

The pulse sensor works with infrared light and measures the variations in translucence in your skin, which are produced by your pulse beat. Rub your ear ten times strongly to activate the blood circulation before attaching the pulse sensor to your earlobe.

Avoid disturbing pulses.

- Attach the ear clip properly to your earlobe and look for the best point for the measurement (heart symbol blinks without interruption).
- Do not train directly under strong incidence of light, e.g. neon light, halogen light, spotlight, sun light.
- Completely eliminate any shocks or bounces of the ear sensor and the cable. Always attach the cable with a clip at your clothing or, even better, at your headband.

With breast clip

The internal pulse receiver is compatible to un-coded POLAR chest strap transmitters. For coded systems, wrong pulse values may be displayed. We recommend T34 by POLAR. Please observe the corresponding instructions.

A plug-in receiver is not necessary and should not be used for technical reasons.

With hand pulse

An extra-low voltage caused by the contractions of your heart is registered by the hand sensors and evaluated by the electronics assembly of the device.





- Always grab the contact faces with both hands.
- Avoid jerky grasping.
- Hold your hands calmly and avoid contractions and rubbing on the contact faces.

Comment:

Only one way of pulse measurement is possible: either with ear clip or with hand pulse or with breast belt. If no ear clip is located in the pulse plug, hand pulse measurement is activated. If you insert an ear clip in the pulse plug, hand pulse measurement is automatically deactivated. It is not necessary to disconnect the plug of the hand pulse measurement.

Faults in the Training Computer

If the computer display is not functioning correctly, please remove the power supply and switch off the machine.

		
	✓	✓
	optional	✓
	optional	optional

For Your Safety:

Before beginning your program of exercise, consult your doctor to ensure that you are fit enough to use the equipment. Base your program of exercise on the advice given by your doctor. Incorrect or excessive exercise may damage your health.



SUPER SMALL FULLY RECUMBENT BIKE

MODEL # SS101

THE WORLD'S SMALLEST COMMERCIAL QUALITY EXERCISE BIKE!
FEATURES INCLUDE: SIMPLE ADJUSTABLE TENSION AS WELL AS
MULTIPLE COMPUTER PROGRAMS, PORTABLE WHEEL SYSTEM,
ADJUSTABLE SEAT, ADJUSTABLE PEDAL STRAPS, HEART RATE
CONTROL CAPABILITY, CONTACT HEART RATE SENSORS,
COMPUTER READOUT OF HEAR RATE, SPEED, TIME, DISTANCE
AND CALORIES. THIS BIKE IS DESIGNED FOR EARLY AGE
ELEMENTARY CHILDREN (K-3RD GRADE).

AGES 4 - 9

WEIGHT: 125 LBS

REVISION: 1/16/2014



9110 C BOLD
PULLEY 52 34-20
12 PROGRAMS AND CALORIES
HEART RATE CONTACT HEART RATE
SENSORS, CONTACT HEART RATE
CONTROL CAPABILITY, SPEED, TIME,
DISTANCE AND CALORIES

