



Bidet Attachment – Installation Guide

PRODUCT INFORMATION

PRODUCT COMPONENTS

Product Components

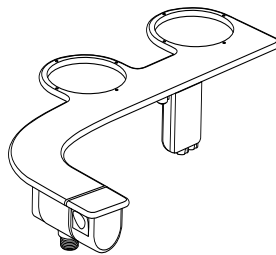

Bidet attachment with ergonomic control

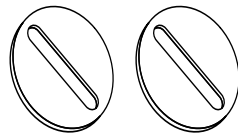

Adjustable mounting brackets (2)

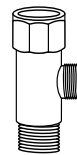

T-Valve connector with included rubber cone washer
($\frac{7}{8}$ " x $\frac{7}{8}$ " x $\frac{3}{8}$ ")

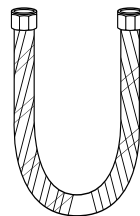

27 $\frac{1}{2}$ " braided metal bidet hose



Teflon Tape

PRODUCT INFORMATION

PRODUCT INFORMATION

Product Dimensions

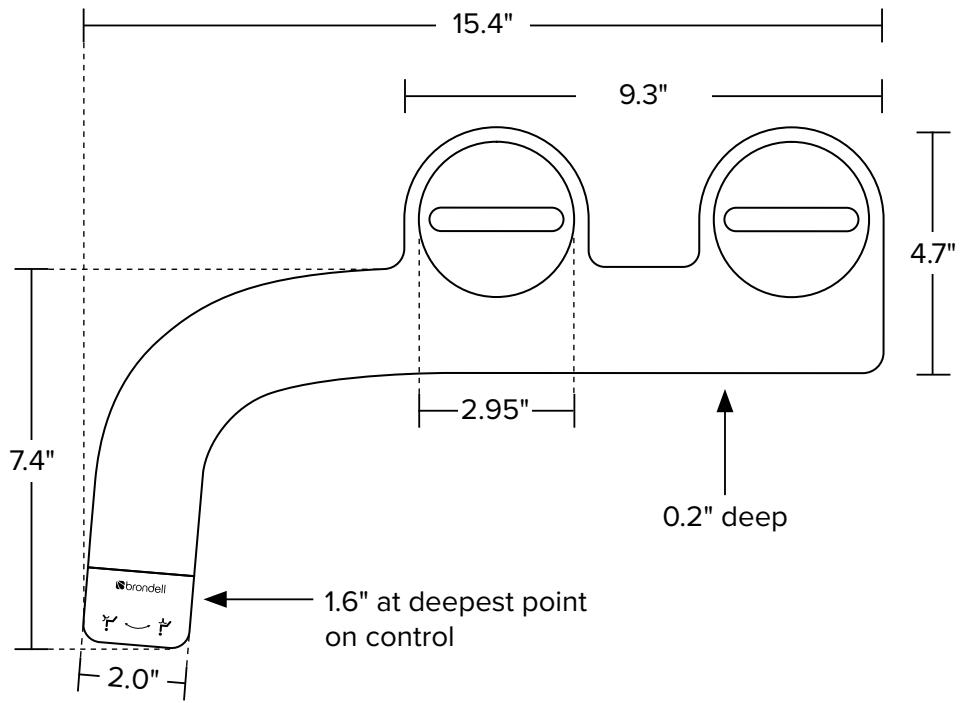

BEFORE INSTALLATION

PRODUCT INSTALLATION

Before Installation

IMPORTANT

Please be advised that the provided T-Valve should be installed at the Fill Valve under the toilet tank, and NOT at the cold water supply coming from the wall.

If you do not have access to the Fill Valve under the toilet tank, contact Brondell Customer Service at 888.542.3355. We may be able to provide alternative options.

Check Water Supply Line

Check the water supply line that connects the toilet tank fill valve to the water shut-off valve at the wall. If it is a rigid pipe, you will need to purchase a flexible water supply hose to replace it before installing the SimpleSpa. The length of the hose you purchase may vary, but the top connection size should be $\frac{7}{8}$ " Ballcock (to connect to the T-valve that you will install under the toilet tank), and the bottom connection will be $\frac{3}{8}$ " or $\frac{1}{2}$ " female compression (to connect at the shut-off valve at the wall).

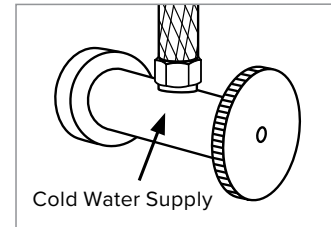

INCORRECT

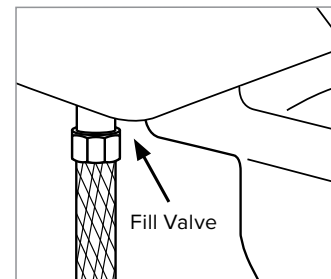

CORRECT

INSTALLING THE BIDET ATTACHMENT

PRODUCT INSTALLATION

Installing the Bidet Attachment

1. Remove the existing toilet seat.
 - a. Lift hinge covers and use flathead or Phillips head screwdriver to remove the mounting bolts. Alternatively, you may need to loosen mounting bolts underneath the seat.
 - b. Remove the toilet seat and set the seat, mounting bolts, and hardware aside.
2. Turn off water supply valve and flush toilet.
 - a. Turn off water supply at the wall to stop flow of water.
 - b. Flush toilet and hold down handle to completely empty toilet tank.
 - c. Disconnect water supply hose from the fill valve under the toilet tank.
3. Connect $\frac{7}{8}$ " T-Valve to Water Supply Line and Fill Valve under Toilet Tank.
 - a. Install the $\frac{7}{8}$ " T-valve with included rubber washer to the incoming water connection on the bottom of your toilet tank. Ensure the rubber washer is properly seated, tapered side up.
 - b. Connect the cold water supply line coming from the wall to the bottom of the T-valve.

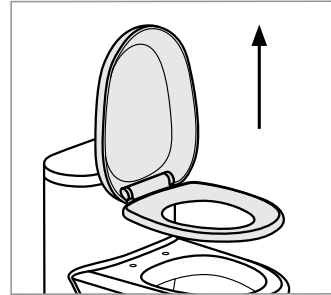

Step 1b

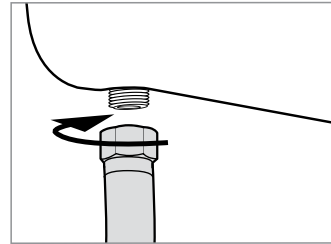

Step 2c

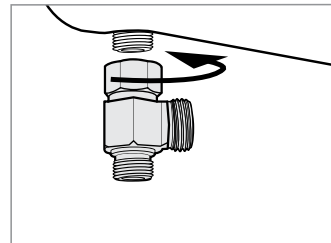

Step 3a

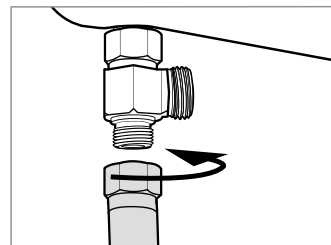

Step 3b

INSTALLING THE BIDET ATTACHMENT (cont.)

PRODUCT INSTALLATION

Installing the Bidet Attachment

4. Connect the Bidet Hose to the T-Valve.
 - a. The ends of the bidet hose are two different sizes. Determine which is the smaller of the two ends.
 - b. Connect the smaller end of the braided metal bidet hose to the remaining open side of the installed T-valve.

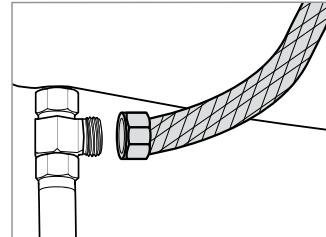

Step 4b

5. Install Adjustable Mounting Brackets into the Bidet Attachment
 - a. Line up the dots of one of the adjustable mounting brackets with the dots around one of the open mounting bracket holders.
 - b. Push the bracket into the bracket holder until it snaps into place.
 - c. Repeat Steps 1 and 2 to install the other adjustable mounting bracket.

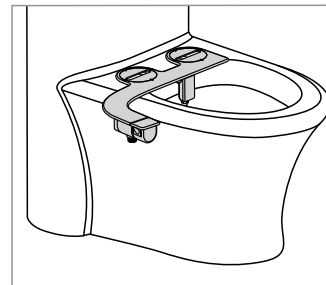

Step 6a

6. Install Bidet Attachment on Toilet.
 - a. Place bidet attachment on the toilet with the nozzles close to the back of the toilet, leaving a slight gap between the toilet and the nozzles. This will vary by toilet.
 - b. Make sure the adjustable brackets line up with the holes in the toilet fixture. You may need to rotate the adjustable brackets accordingly to line up properly.
 - c. Replace the toilet seat on top of bidet attachment and secure using original toilet seat hardware. Make sure to tighten so that the bidet attachment and seat do not move.
 - d. Ensure the control knob is lying flat and isn't turned to one of the operating positions to prevent water from accidentally spraying out of the toilet bowl.

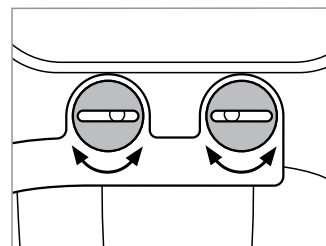

Step 6b

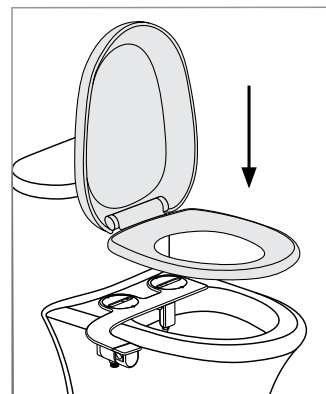

Step 6c

INSTALLING THE BIDET ATTACHMENT (cont.)

PRODUCT INSTALLATION

Installing the Bidet Attachment

7. **Connect the Bidet Hose to the Bidet Attachment**
Connect open end of bidet hose to the connection underneath the bidet attachment.
8. **Turn on the Water Supply and check for leaks.**
 - a. Open the main water supply valve slowly and check for leaks.
 - b. Wait 5-10 minutes, check again and if there are no leaks, continue.

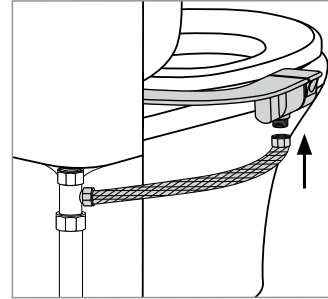

Step 7

NOTE: If there is any leaking, check all rubber washers and make sure all water connections are tight and secure. If necessary, you can use the provided Teflon Tape (Plumber's Tape) for any leaking connections.