

**BIOMOL**<sup>®</sup>



# RED LIGHT THERAPY DEVICES

PROFESSIONAL MANUFACTURER IN CHINA SINCE 2015



## WHY NEED RED LIGHT THERAPY?

Red light therapy, also known as low-level laser therapy (LLLT) or photobiomodulation, offers a range of benefits that make it a popular choice for various health and wellness concerns. This non-invasive treatment utilizes specific wavelengths of red light to penetrate the skin and stimulate cellular repair and rejuvenation processes.

It can help reduce inflammation, improve collagen production, and enhance overall skin tone and texture, making it effective for addressing issues like acne, wrinkles, and scars. Furthermore, red light therapy is known for its pain-relieving properties and its ability to accelerate wound healing. By increasing circulation and reducing inflammation, it can aid in managing chronic pain conditions and promoting faster recovery from injuries.

Additionally, red light therapy has been shown to boost mood and improve sleep quality by regulating circadian rhythms and promoting the production of serotonin, often referred to as the "feel-good" hormone. Whether you are looking to enhance your skin's appearance, alleviate pain, or improve your overall well-being, red light therapy provides a safe and effective solution with a wide range of applications for various health concerns.

# CONTENT

---

## 01 ABOUT BIOMOL

## 03 PORTABLE SERIES

BM - Super

BM - Slim

BM - Mini

## 16 HOUSEHOLD SERIES

H320

H760

H1520

## 24 HOUSEHOLD PRO SERIES

HP360

HP720

HP1080

HP1440

HP1800

## 32 BEAUTY MEDICAL SERIES

BM - Beauty

## 39 FITNESS SERIES

BM - Fitness

## 45 RP SERIES

RP360Z

RP720Z

RP1080Z

RP1440Z

RP1800Z

RP2800Z

RP3600Z

RP4320Z

## 56 RL SERIES

RL300A

RL300B

RL600

RL900

RL1200

RL1500

RL1800

## 64 WEARING SERIES

BM-Cap-A

BM-Cap-B

BM-Mask

BM-Belt

BM-Pad

BM-Mat



Welcome to BioMol.

We are one of the top-rated manufacturers of Red Light Therapy devices, with a 2200 square meters factory located in Shenzhen China since 2015.

With over 60 staff members, we ensure a production capacity of 2000pcs per month for quick lead time. Our products are of top quality and built with CE, RoHs, FCC and FDA certificates. Furthermore, our factory complies with ISO 9001 standards.

For an enterprise, innovation is the foundation of long-term development. BioMol Therapy has a strong R&D team of over 10 people to ensure continuous product innovation each year. All our products are patented with unique designs. We take pride in being the ONLY company producing Red Light Therapy devices with Voice Control. Additionally, we are the ONLY company to divide our product line into different series based on their applications.

Our product series include:

- Portable Series
- Household Series
- Household Pro Series
- General Series
- Beauty Medical Series
- Fitness Series
- RP Series
- RL Series
- Wearing Series
- Pets Care Series

Our products are with the following unique features:

- Smart Voice control
- 2-8 channels with dimming & timing & pulse
- Pre-set modes for quick use & customized modes with settings
- The highest irradiance devices available on the market

With our professional and strong R&D team, you are always welcome to customize your exclusive products through our OEM&ODM service, and we provide FREE design service.

Choosing BioMol as your business partner will provide you with high-quality guarantee services for your market competition and long-term development.

Let's begin a win-win cooperation now!

CEO  
Ivy / Miss Chao

## WHY CHOOSE US?

 <p>Professional manufacturer with 16 years experience in red light therapy industry.</p>	 <p>Strong R&amp;D team with 20+ members with 3-4 new series annually.</p>	 <p>Unique design with voice control function (the only supplier on the market).</p>
 <p>Free OEM&amp;ODM design service.</p>	 <p>High quality of 3-year warranty with new replacement.</p>	 <p>FDA, CE, RoHS certificates for guarantee usage.</p>

# OUR COMPANY

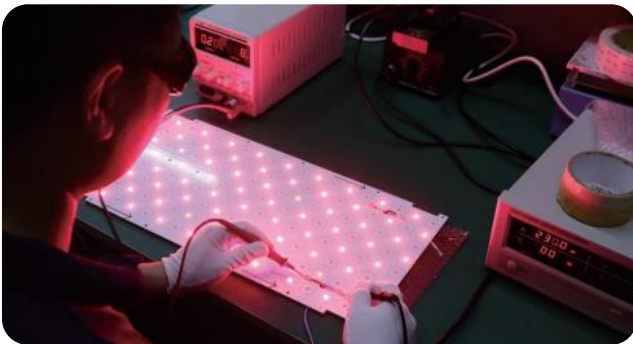
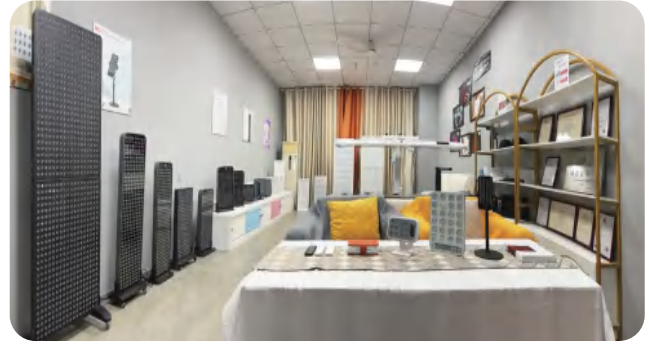

# CERTIFICATION



**BIOMOL**<sup>®</sup>

# PORTABLE SERIES BM-SUPER







How to make yourself beautiful and healthy anytime, anywhere?

A portable red light therapy device can easily serve it.

Small in size, easy to carry, essential for travel, uninterrupted enjoyment and no burden on luggage.

Smart program, touch key&screen, easy to operate.

Just enjoy it!

-  Wake-up & sleep music
-  Sunrise wake-up light
-  4 Spectra
-  Voice Control
-  Touch Screen
-  Intelligent controller
-  Magnetic suction charging bracket
-  Bluetooth
-  Small size & portable
-  10000mAh battery
-  Plastic housing



# SUPER

## It's not just a red light therapy device



### Therapy Mode (R&IR light)

Promote blood circulation, improve lower back pain and soreness, and increase healthy physique.



### Sleep Mode (R&IR light)

Help to fall asleep quickly, get deep sleep, improve sleep quality, and make the new day full of energy.



### Wake-up Mode (Timed start of sunrise light with music)

Wake up in the sunrise and nature music, and start a wonderful day!



### Night Lamp (Surround light)

The warm and soft lights at night drive away your loneliness in the dark.



### Voice Control

You speak, she does. It's just that simple.

No need to manually turn on the lights, just speak (voice control).



### Bluetooth

That's right, it's still a Bluetooth speaker! Connect your phone: When you enjoy light therapy, you can listen to music.

When you activate sleep mode, you can listen to music.

When you only want to listen to music, you can listen to music.

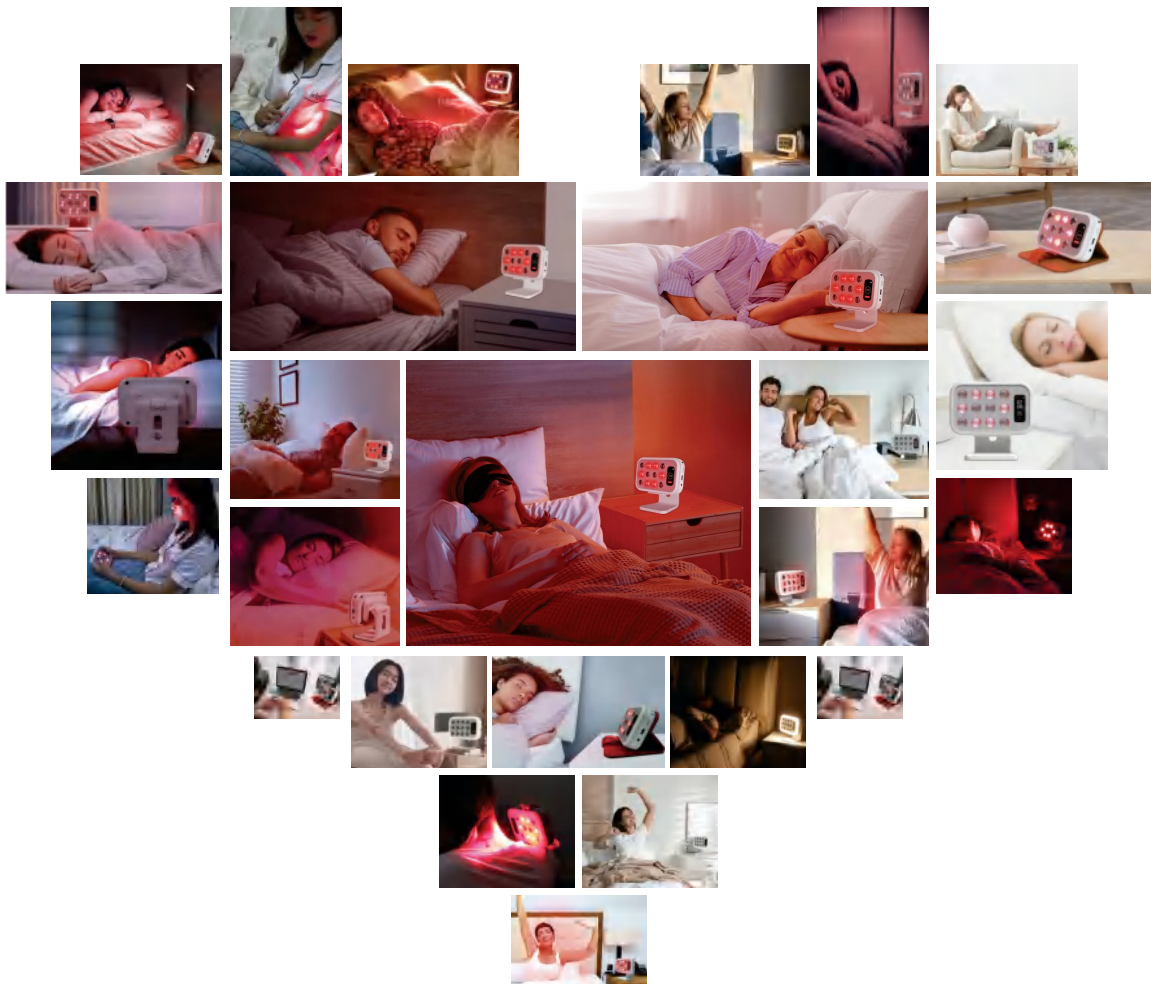

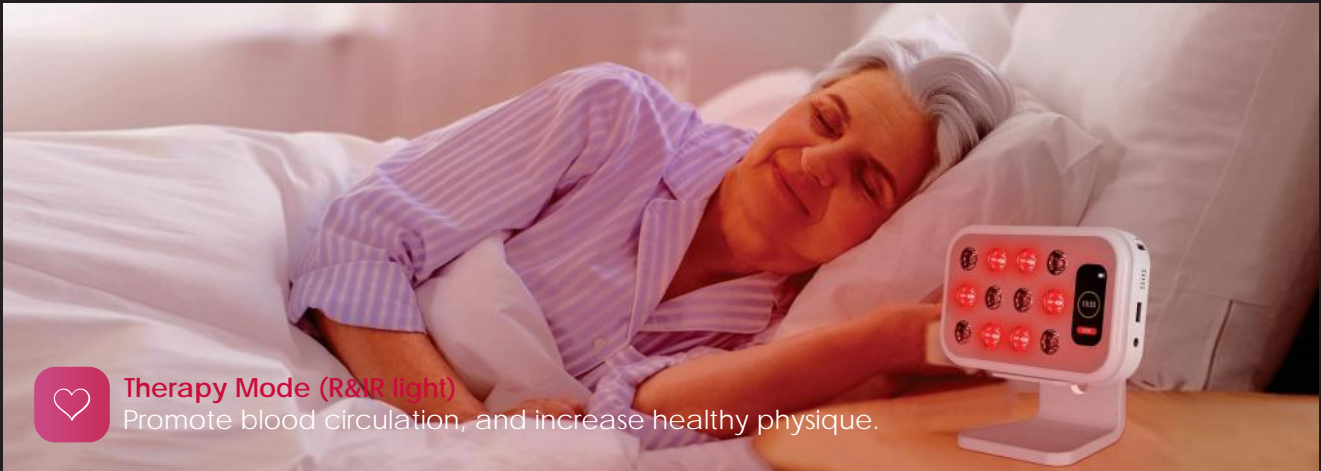

**Therapy Mode (R&R light)**

Promote blood circulation, and increase healthy physique.



**Sleep Mode**

Improve sleep quality

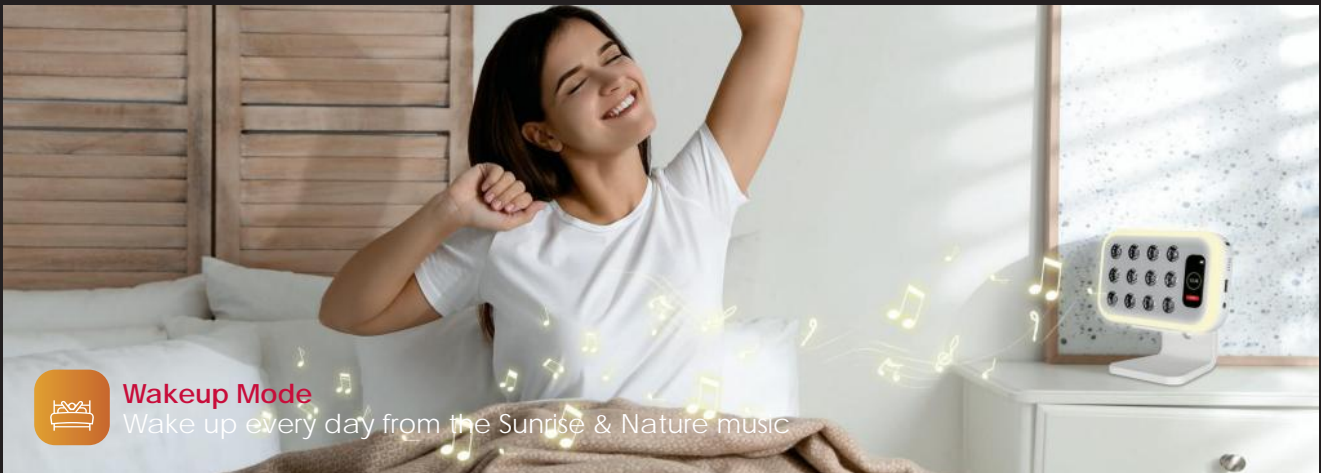

**Wakeup Mode**

Wake up every day from the Sunrise & Nature music

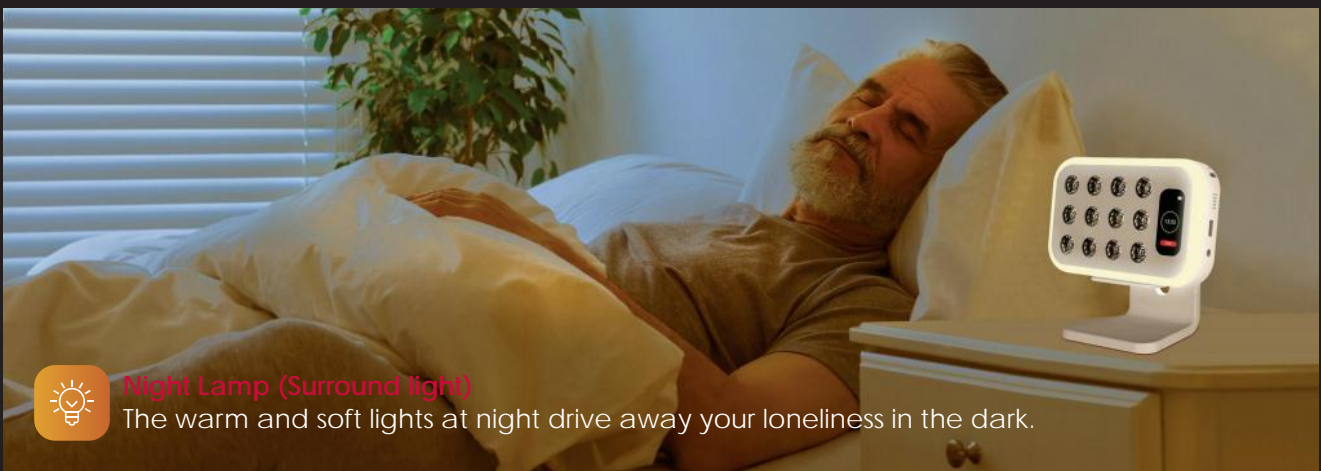

**Night Lamp (Surround light)**

The warm and soft lights at night drive away your loneliness in the dark.



# VOICE CONTROL SYSTEM

Respond immediately and start your exclusive care mode remotely



## VOICE

Turn on/off the voice control function

### Voice Settings

Wake-up: Hi/Hello Super

Command: Turn on therapy mode

C: Turn on wakeup mode

C: Turn off wakeup mode

C: Turn on sleep mode

C: Stop

C: Turn on Bluetooth

C: Turn off Bluetooth

C: Turn on night lamp

C: Turn off night lamp

C: Volume up

C: Volume down

(Valid for 15s)

R: OK, therapy mode is ON

R: OK, wakeup mode is ON

R: Ok

R: OK, sleep mode is ON

R: OK (only valid for countdown)

R: OK, Bluetooth is ON

R: Ok

R: Ok

R: Ok

R: Ok

R: Ok

# BIOMOL TOUCH SCREEN

Smart touch panel, smart life



## IRRADIANCE TEST

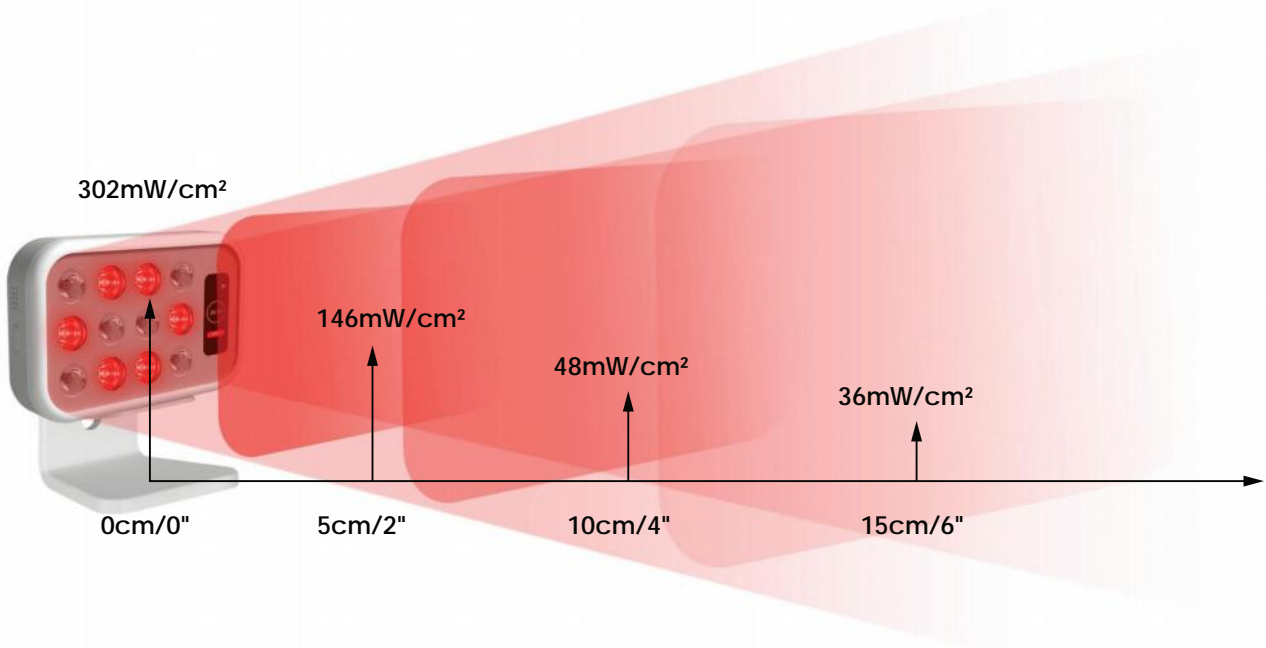

# BM-SUPER

LEDs:	12x5W 3535 LED
Wavelength:	630nm/660nm/830nm/850nm
Beam angle:	30 degrees
Control way:	Touch screen & Voice controll
Voltage:	100-240V
Irradiance:	>300mW/cm <sup>2</sup>
Pulse:	0-9,999Hz
Flicker:	Flicker free
EMF:	0.0µt
Use way:	Handheld&Table stand
Lifespan:	>50,000 Hours
Warranty:	1 Year
Recharging time:	90 min
Battery life:	120 min
Material:	Plastic
Product size:	163 x 105 x 35mm / 6.6"x 4.3"x 1.4"
Product weight:	0.6KG/1.3LB
Gross weight:	1.65KG / 3.64LB
Packing:	360 x 160 x 13mm / 14.17" x 6.3" x 5.12"

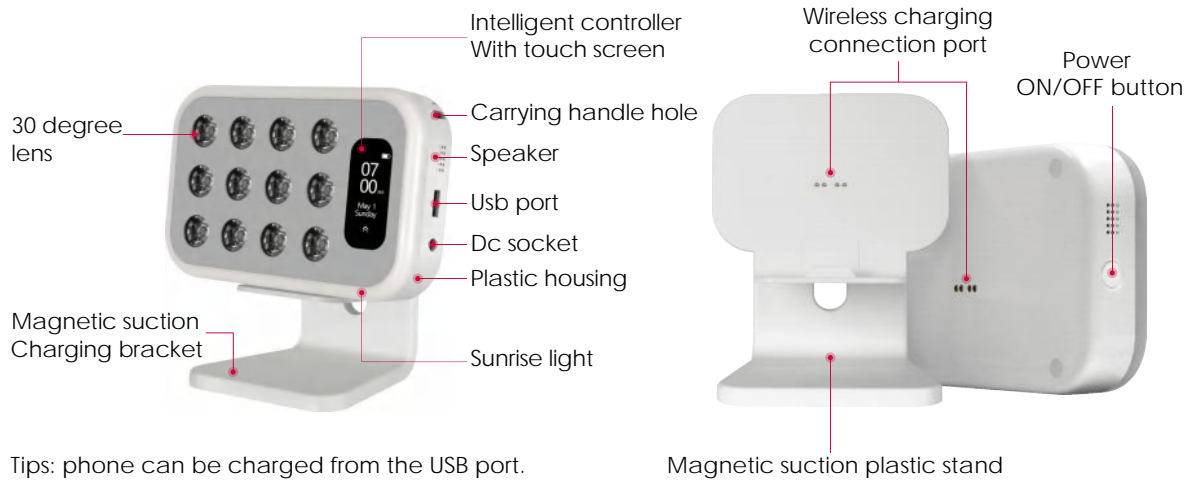

## PACKAGE CONTENTS

- BioMol super device x 1
- Ice-silk eyeshade x 1
- Readable glasses x 1
- Leather case x 1
- Magnetic suction plastic stand x 1
- Strap x 1
- DC adapter x 1
- User manual x 1

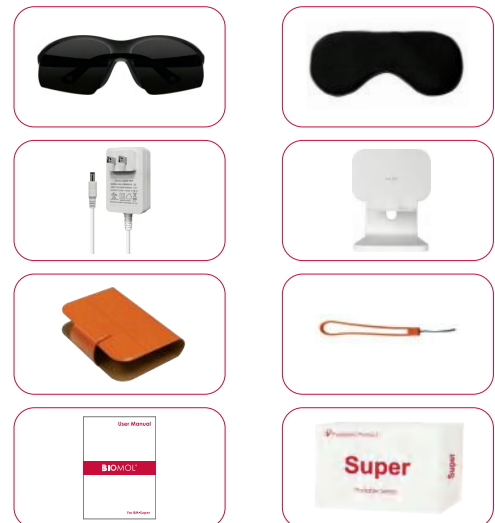

# BIOMOL<sup>®</sup>

## PORTABLE SERIES

### BM-SLIM



Skin care & anti-aging

Promote collagen synthesis: red light therapy can promote the synthesis of collagen in the skin, making it more firm and elastic.

Improve pigmentation: red light therapy can regulate collagen production, reduce pigment deposition, and improve pigmentation problems.

Shrink pores: red light therapy can promote the metabolism of skin cells, clean and shrink pores.

Just enjoy it!



6 Default Modes



6 Spectra



120 x 0.5W LEDs



Aluminum Housing



Touch Key



Small Size &  
Portable



# BioMol Slim



### Skin rejuvenation

- Spectrum: Red 630nm&660nm
- Timing: 5/10/15/20 minutes
- Usage: 1-2 times a day, 5-30cm distance



### Skin whitening

- Spectrum: Red 630nm&660nm  
Yellow 590nm
- Timing: 5/10/15/20 minutes
- Usage: 1-2 times a day, 5-30cm distance



### Acne treatment

- Spectrum: Blue 450nm /Red 630nm&660nm/NIR 850nm&940nm
- Timing: 15 minutes  
(5mins Blue + 10mins Blue/Red/NIR)
- Usage: once a day, 10-30cm distance



### Skin firming

- Spectrum: Red 630nm&660nm  
NIR 850nm&940nm
- Timing: 5/10/15/20 minutes
- Usage: 1-2 times a day, 5-30cm distance



### Freckle treatment

- Spectrum: Yellow 590nm
- Timing: 5/10/15/20 minutes
- Usage: 1-2 times a day, 5-30cm distance



### Oil control & purifying

- Spectrum: Blue 450nm/Yellow 590nm/Red 630nm&660nm/  
NIR 850nm&940nm
- Timing: 15 minutes  
(5 mins B/Y/R/NIR+ 10 mins Y/R/NIR)
- Usage: once a day 10-30cm distance

# TOUCH KEYS

Simple to control the device

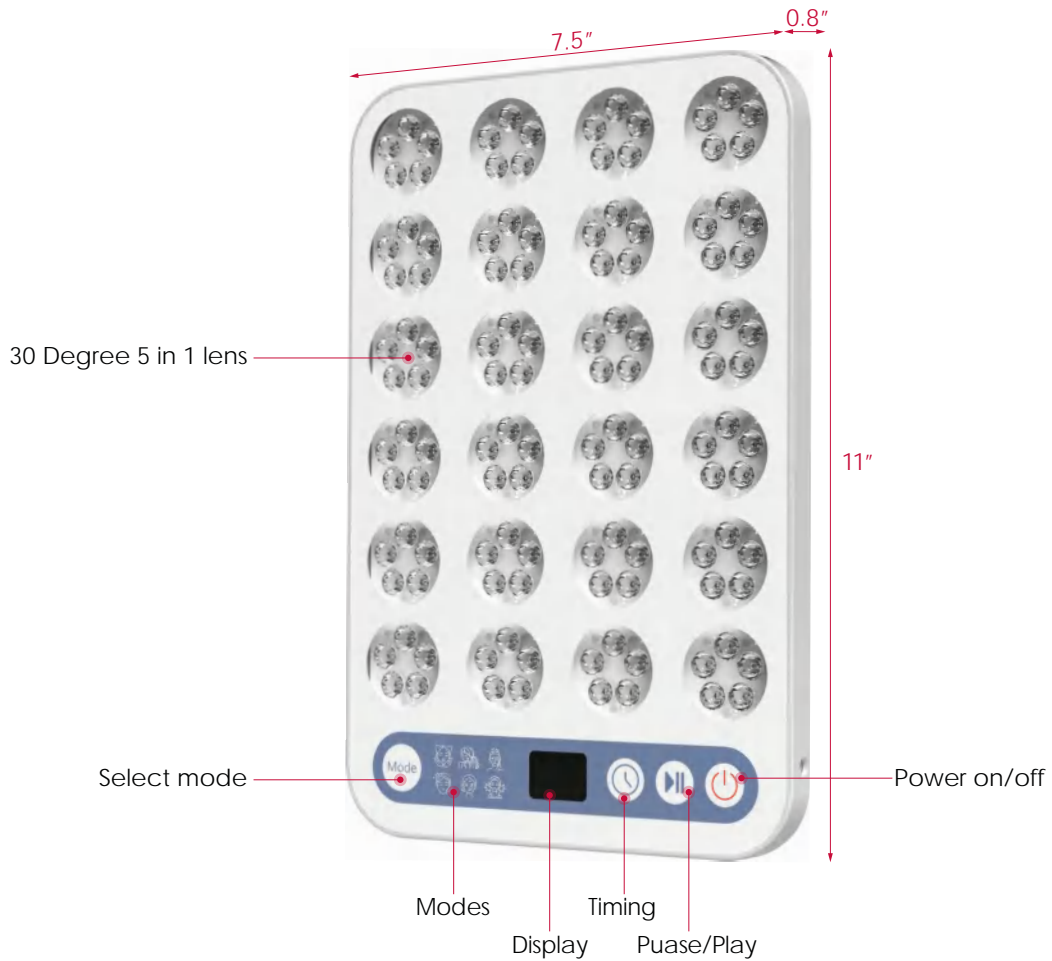
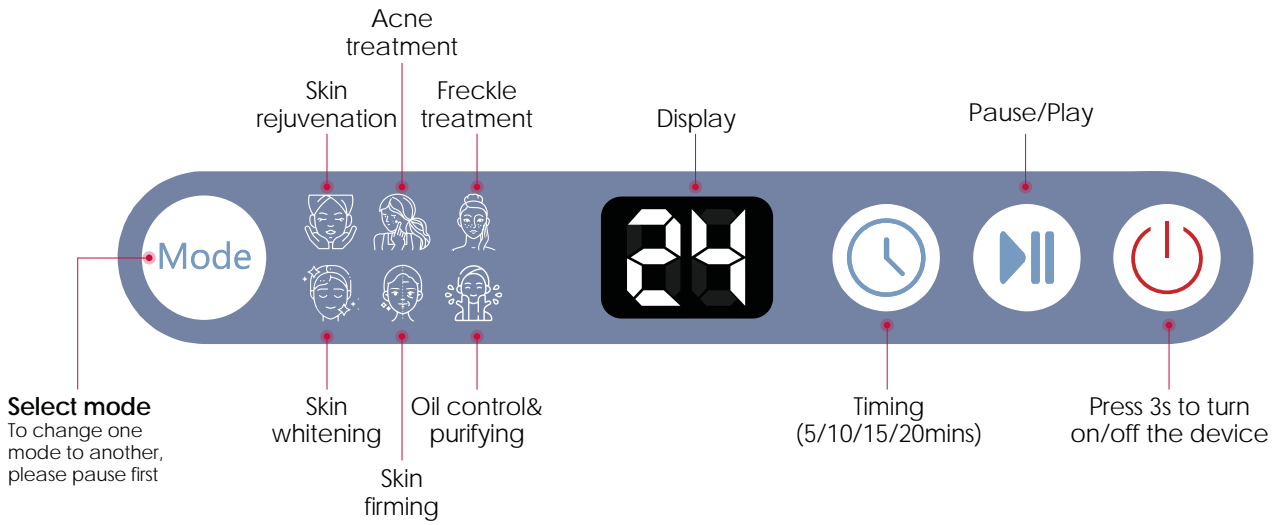

# BM-Slim

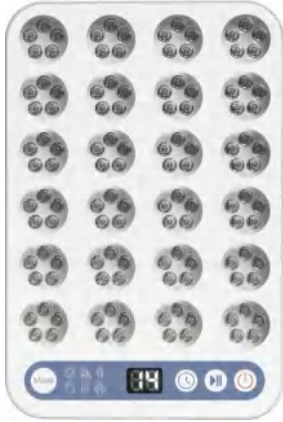

LEDs:	120x0.5W LED
Wavelength:	RED (630nm+660nm)
	NIR (850nm+940nm)
	BLUE (450nm)
	Yellow (590nm)
Beam angle:	30 degrees
Control way:	Touch key
Voltage:	AC100-240V
Irradiance:	>133mW/cm <sup>2</sup>
Flicker:	Flicker free
EMF:	0.0μt
Use way:	Handheld / Table stand / Floor stand
Application:	Face treatment
Lifespan:	>50,000 Hours
Warranty:	1 Year
Material:	Aluminum
Product size:	280 x 190 x 20mm / 11"x 7.5"x 0.8"
Product weight:	1KG/2.2LB
Gross weight:	1.7KG/3.75LB
Packing:	350x240x90mm/13.8" x 9.5" x 3.5"

## IRRADIANCE TEST

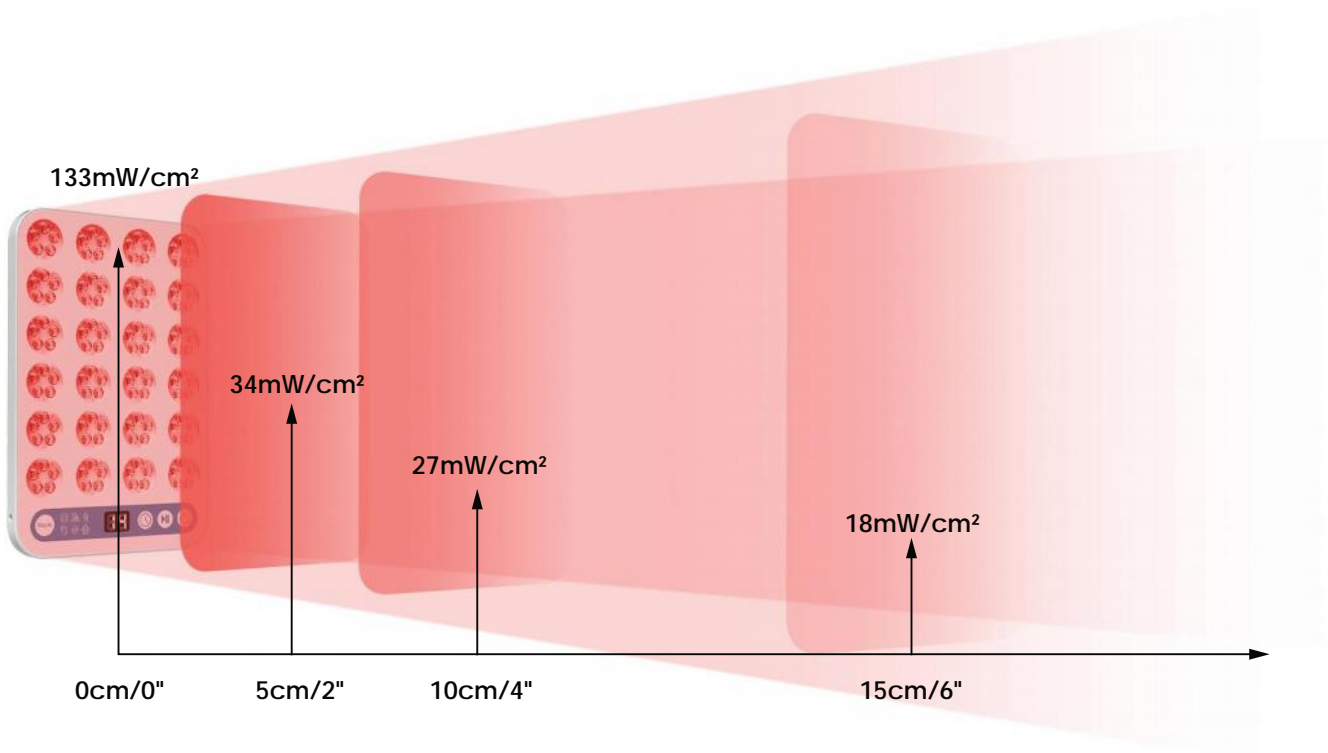

# STAND



Table stand



Adjustable floor stand  
(Optional)

# PACKAGE CONTENTS

- BioMol LED red light therapy panel x 1
- Readable glasses x 1
- DC adapter x 1
- BioMol user manual x 1
- Table stand x 1

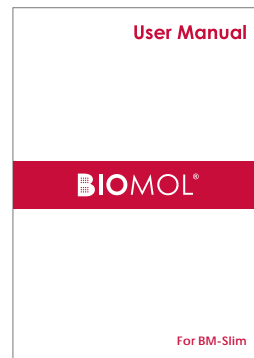



# BIOMOL<sup>®</sup>

## PORTABLE SERIES

### BM-MiNi



Small and portable just like an iPhone. Become more beautiful and healthier anywhere at anytime.

Rechargeable. Just with a Type-C cable, no worry about service interruption at anytime.

Simple operation, one touch start and timed close. Simply enjoy professional care.

FDA certification provides a full range of use guarantees.



90 x 0.2W LEDs



Aluminum  
Housing



Touch Key



Small Size &  
Portable



5000mAh  
battery



Type-C charging  
socket



Auto-timing



## BM-MiNi

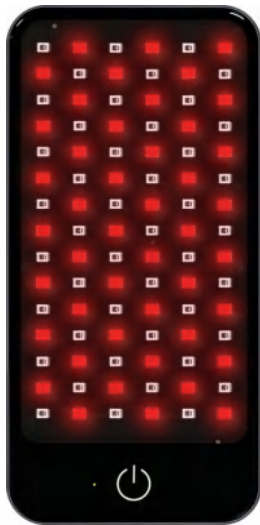

LEDs:	90x0.2W 2835 LED
Wavelength:	660nm/850nm
Beam angle:	120 degrees
Control way:	Touch key
Battery life:	80 mins
Recharging time:	60 mins
Voltage:	AC100-240V
Irradiance:	>84mW/cm <sup>2</sup>
Flicker:	Flicker free
EMF:	0.0μt
Use way:	Handheld / Table stand
Application:	Face/Target treatment
Lifespan:	>50,000 Hours
Warranty:	1 Year
Material:	Aluminum
Product size:	158 x 77.5 x 13.6mm/6.2" x 3" x 0.53"
Product weight:	0.3KG/0.7LB
Gross weight:	0.5KG/1.1LB
Packing:	172 x 91 x 35mm / 6.8"x 3.6"x 1.4"

## PACKAGE CONTENTS

- BioMol MiNi LED red light therapy panel x 1
- Silicone protector x 1
- Type C charging cable x 1
- BioMol MiNi user manual x 1

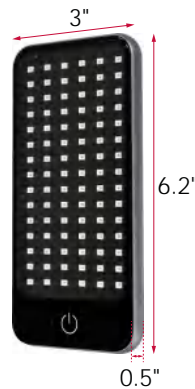
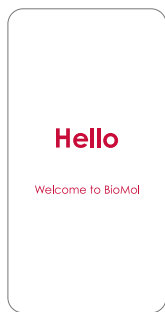

**OPTIONAL STAND**  
(Adjustable 360°  
Titanium steel stand)

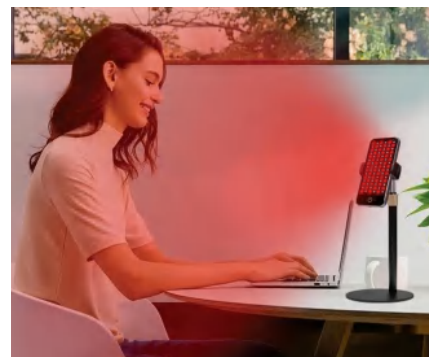
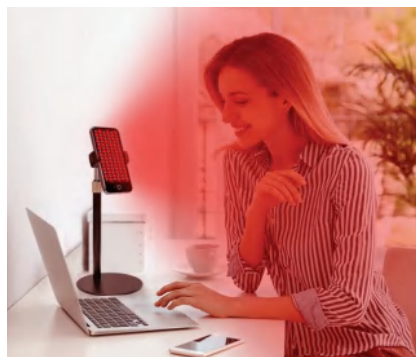
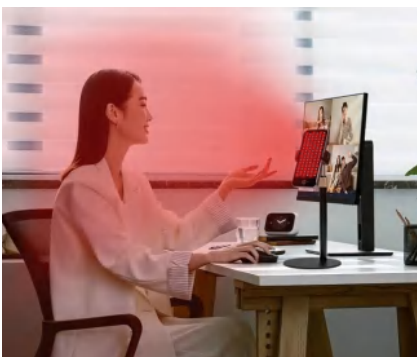



# HOUSEHOLD SERIES LED RED LIGHT THERAPY



No need any appointment to beauty salons or health treatment clubs, you can become beautiful and healthy at home at any time.

BioMol's household series can be used for half body, full body therapy and sports & fitness.

With 7 defaulted modes, no need to set repeatedly.

With dual-mode of touch keys and voice control, simple to control the device at far and near distances.

Infinite gradient mode makes the lights softer when turning on and off.

Just enjoy it!



7 Default Modes  
+1 Customized Mode



6 Spectra



All 3535 5W LEDs



Aluminum Housing



Voice Control



Touch Key

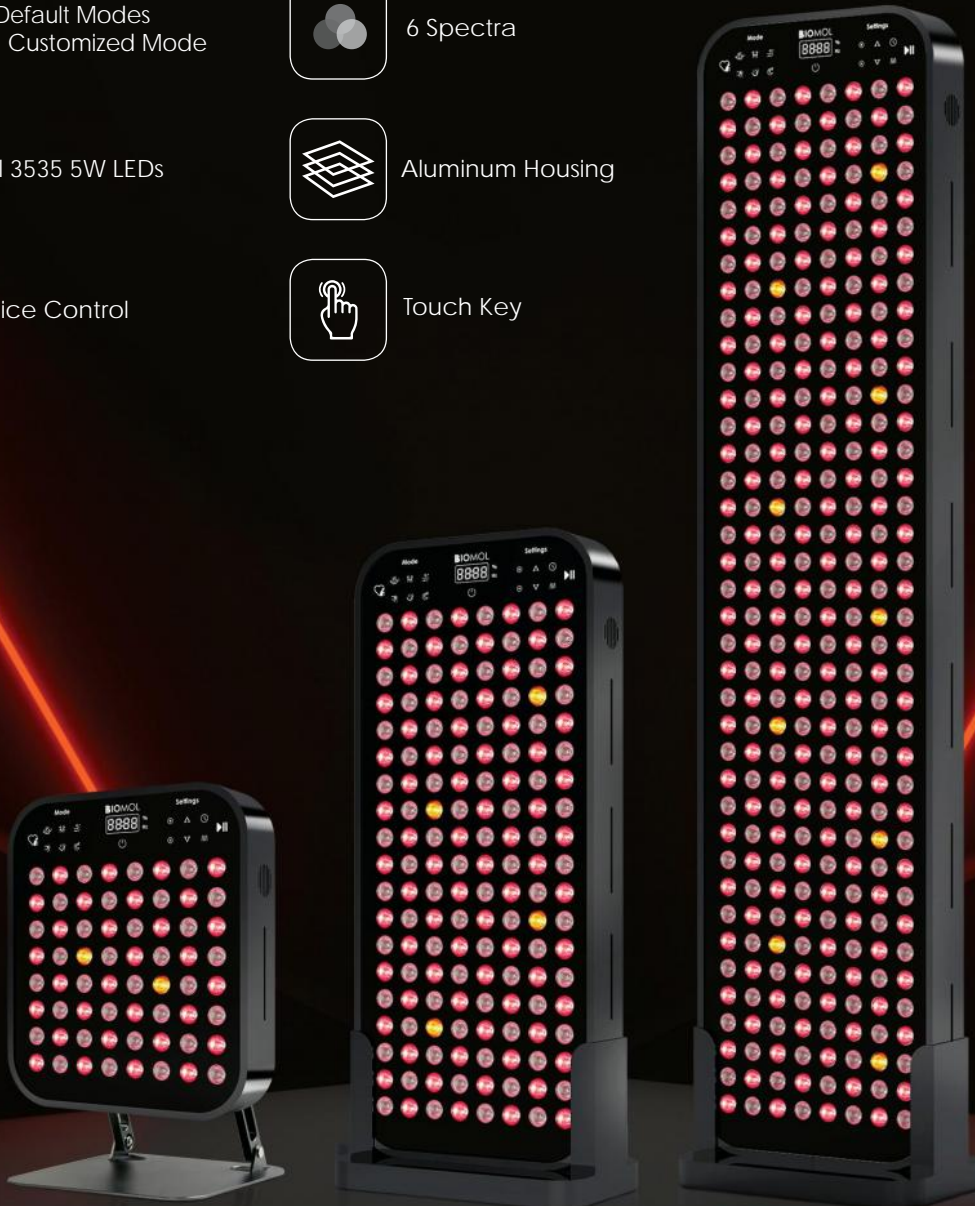

BioMol Household Series



⚠ Please wear glasses or close eyes when enjoying therapy.

# VOICE CONTROL SYSTEM

Respond immediately and start your exclusive care mode remotely,  
Voice control function is to free your hands

## Voice Settings

Wake-up: Hi/Hello BIOMOL

C: Turn on the light

C: Run fitness mode

C: Run fat burning mode

C: Run muscle recovery mode

C: Run inflammation mode

C: Run skin care mode

C: Run sleep mode

C: Run elderly health mode

C: Run setup mode

C: Volume up/down

C: Turn off the light

R: Yes (Valid for 15s)

R: OK

R: OK, Fitness mode is on

R: OK, Fat burning mode is on

R: OK, Muscle recovery mode is on

R: OK, Inflammation mode is on

R: OK, Skin care mode is on

R: OK, Sleep mode is on

R: OK, Elderly health mode is on

R: OK, Setup mode is on

R: Ok

R: Goodbye~



"Hi/Hello BIOMOL"

"Run sleep mode"

"OK"

"Sleep mode is on"

# TOUCH KEYS

Simple to control the device

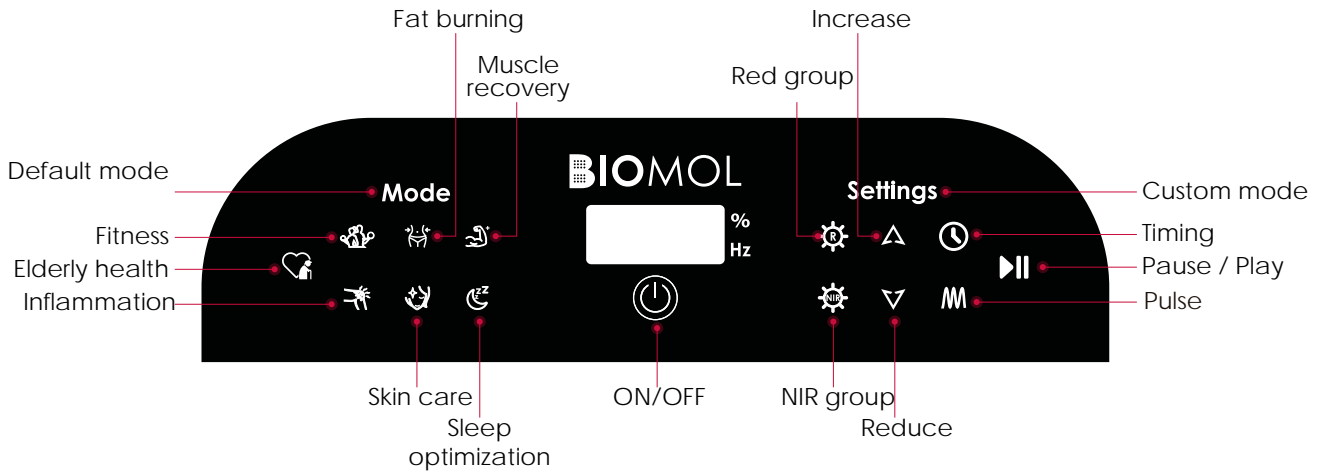

## BIOMOL HOUSEHOLD SERIES

### H320



<b>LEDs:</b>	64x5W 3535 LED
<b>Wavelength:</b>	Channel 1# RED (610nm+630nm+660nm) Channel 2# NIR (810nm+830nm+850nm)
<b>Beam angle:</b>	30 degrees
<b>Control way:</b>	Touch key & Voice control
<b>Voltage:</b>	AC100-240V
<b>Irradiance:</b>	>580mW/cm <sup>2</sup>
<b>Pulse:</b>	0-9,999Hz
<b>Flicker:</b>	Flicker free
<b>EMF:</b>	0.0μt
<b>Use way:</b>	Table stand
<b>Lifespan:</b>	>100,000 Hours
<b>Warranty:</b>	3 Years
<b>Material:</b>	Aluminum
<b>Product size:</b>	300 x 260 x 60mm / 11.8"x 10.2"x 2.4"
<b>Product weight:</b>	3.5KG/7.7LB
<b>Gross weight:</b>	5kg/11LB
<b>Packing:</b>	360x330x180mm/14.2"x13"x7.1"

# BIOMOL HOUSEHOLD SERIES

## H760



<b>LEDs:</b>	152x5W 3535 LED
<b>Wavelength:</b>	Channel 1# RED (610nm+630nm+660nm) Channel 2# NIR (810nm+830nm+850nm)
<b>Beam angle:</b>	30 degrees
<b>Control way:</b>	Touch key & Voice control
<b>Voltage:</b>	AC100-240V
<b>Irradiance:</b>	>586mW/cm <sup>2</sup>
<b>Pulse:</b>	0-9,999Hz
<b>Flicker:</b>	Flicker free
<b>EMF:</b>	0.0μt
<b>Use way:</b>	Floor stand
<b>Lifespan:</b>	>100,000 Hours
<b>Warranty:</b>	3 Years
<b>Material:</b>	Aluminum
<b>Product size:</b>	600 x 260 x 60mm / 23.6"x 10.2"x 2.4"
<b>Product weight:</b>	7.5KG/16.5LB
<b>Gross weight:</b>	9.5kg/20.9LB
<b>Packing:</b>	650x330x180mm/25.6"x13"x7.1"

## H1520



<b>LEDs:</b>	304x5W 3535 LED
<b>Wavelength:</b>	Channel 1# RED (610nm+630nm+660nm) Channel 2# NIR (810nm+830nm+850nm)
<b>Beam angle:</b>	30 degrees
<b>Control way:</b>	Touch key & Remote controller
<b>Voltage:</b>	AC100-240V
<b>Irradiance:</b>	>588mW/cm <sup>2</sup>
<b>Pulse:</b>	0-9,999Hz
<b>Flicker:</b>	Flicker free
<b>EMF:</b>	0.0μt
<b>Use way:</b>	Floor stand
<b>Lifespan:</b>	>100,000 Hours
<b>Warranty:</b>	3 Years
<b>Material:</b>	Aluminum
<b>Product size:</b>	1090 x 260 x 60mm / 42.9"x 10.2"x 2.4"
<b>Product weight:</b>	12.6KG/27.8LB
<b>Gross weight:</b>	16.2kg/35.7LB
<b>Packing:</b>	1180x360x190mm/46.5"x14.2"x7.5"

# IRRADIANCE TEST

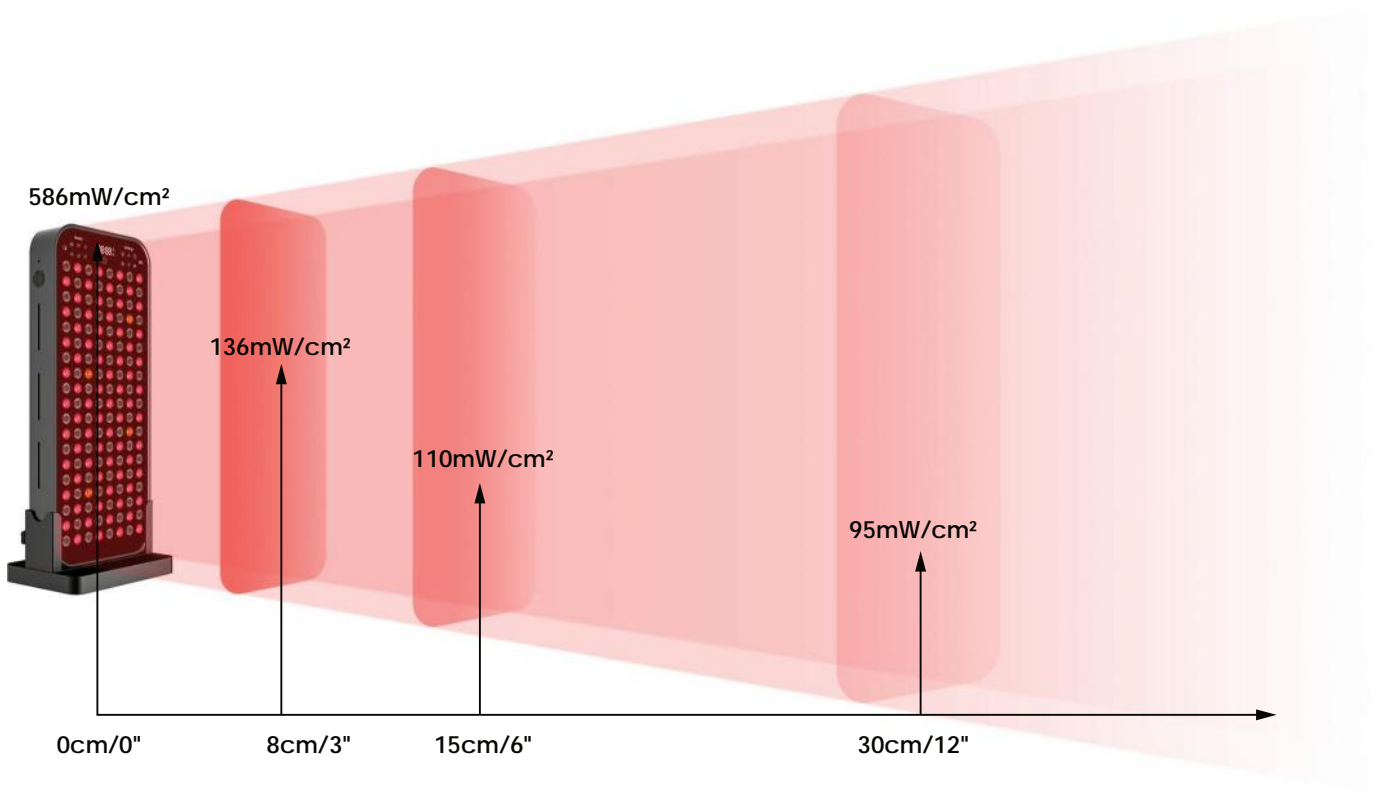
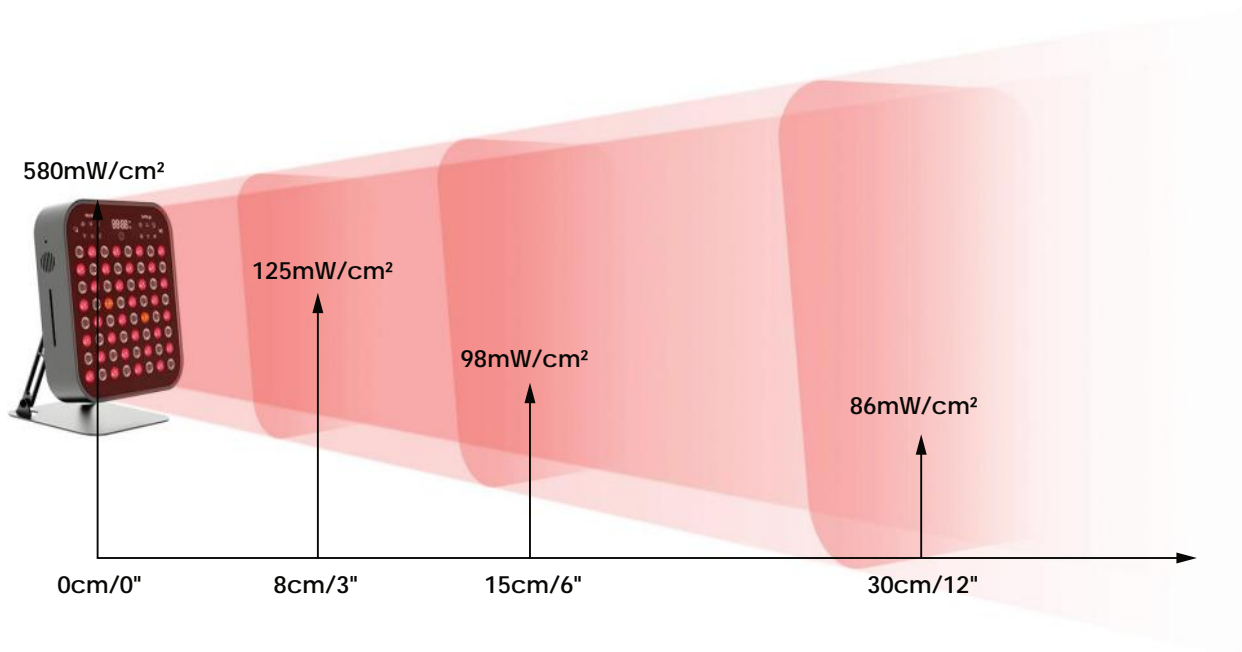



# IRRADIANCE TEST

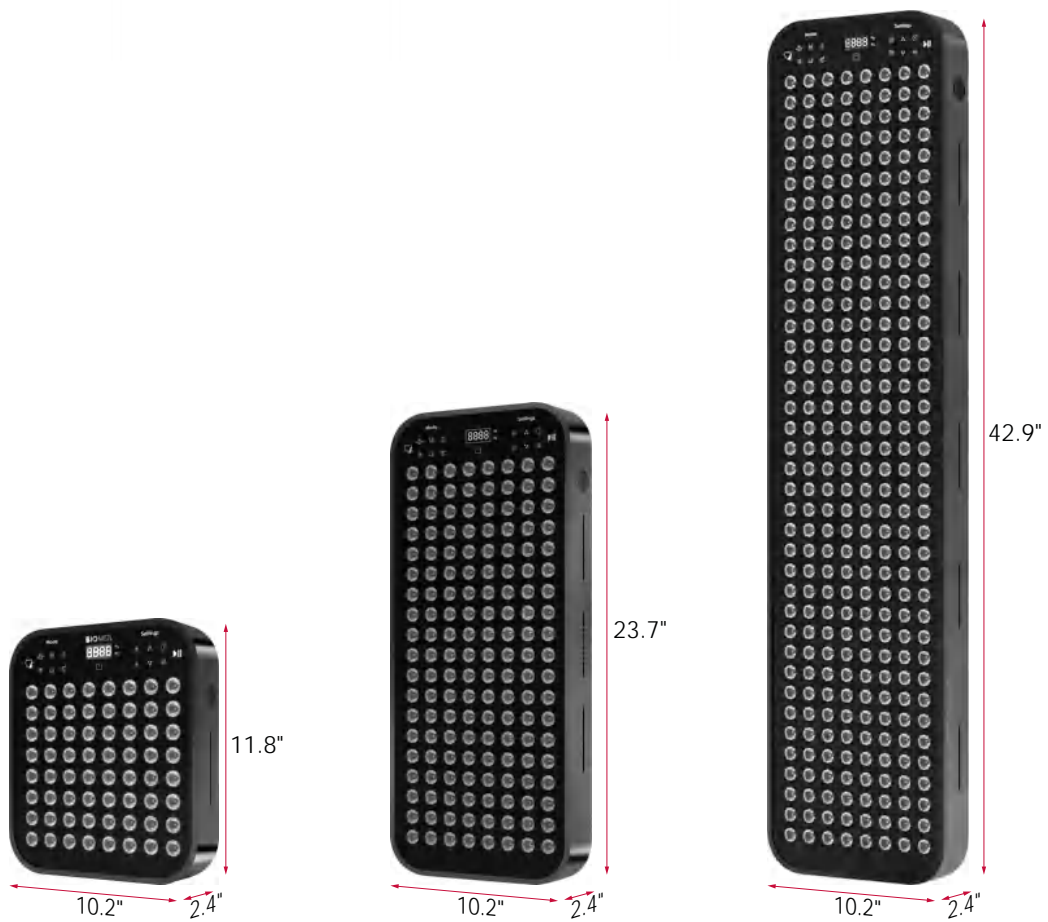
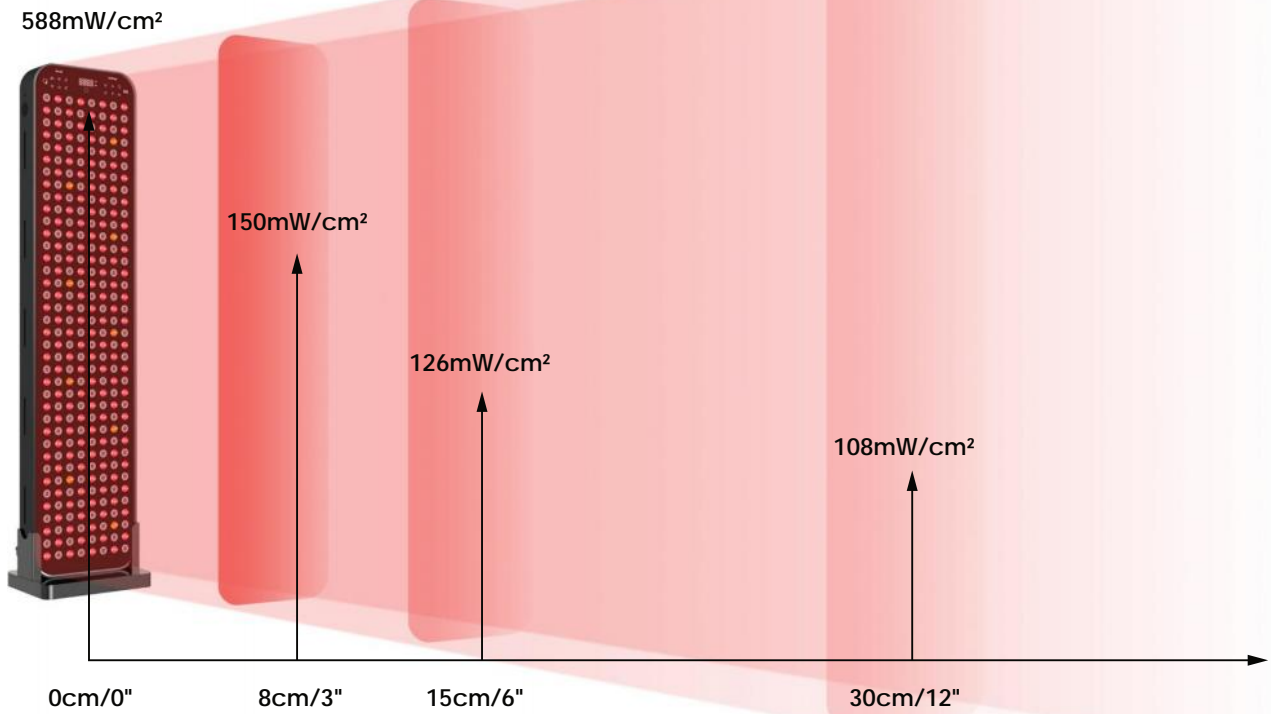

# STAND

## 1. Table top stand (only for H320)



## 2. Folding floor stand (for H760/H1520)

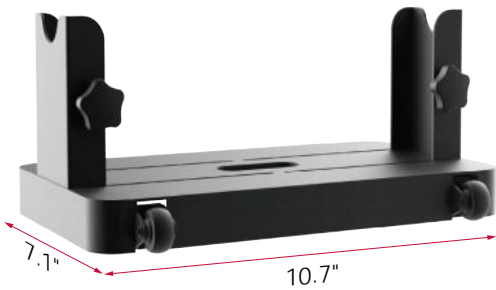

Folding floor stand 2 wheels  
(Standard)

# PACKAGE CONTENTS

- BioMol LED red light therapy panel x 1
- Readable glasses x 1
- Power cable x 1
- Stand x 1
- BioMol user manual x 1





# HOUSEHOLD PRO SERIES LED RED LIGHT THERAPY



No need any appointment to beauty salons or health treatment clubs, the path to beauty and wellness can be traversed within the confines of your own home, at your convenience.

BioMol's sophisticated household pro series caters to half-body and full-body therapy, offering a comprehensive approach to health and vitality. Featuring an array of 6 default modes and 1 customizable mode, the need for repetitive adjustments is eradicated.

With the innovative integration of dual-mode touch keys and a remote controller, effortlessly manage the device from varying distances, ensuring simplicity and control even from afar. Embrace the experience and revel in the benefits it brings forth!



6 Default Modes  
+1 Customized Mode



4 Channels + 7 Spectra



Touch Screen



Remote Controller



All 3535 5w LEDs



Aluminum Housing



BioMol Household Pro Series



⚠ Please wear glasses or close eyes when enjoying therapy.

# BIOMOL TOUCH SCREEN

6 Default modes + 1 Customized mode

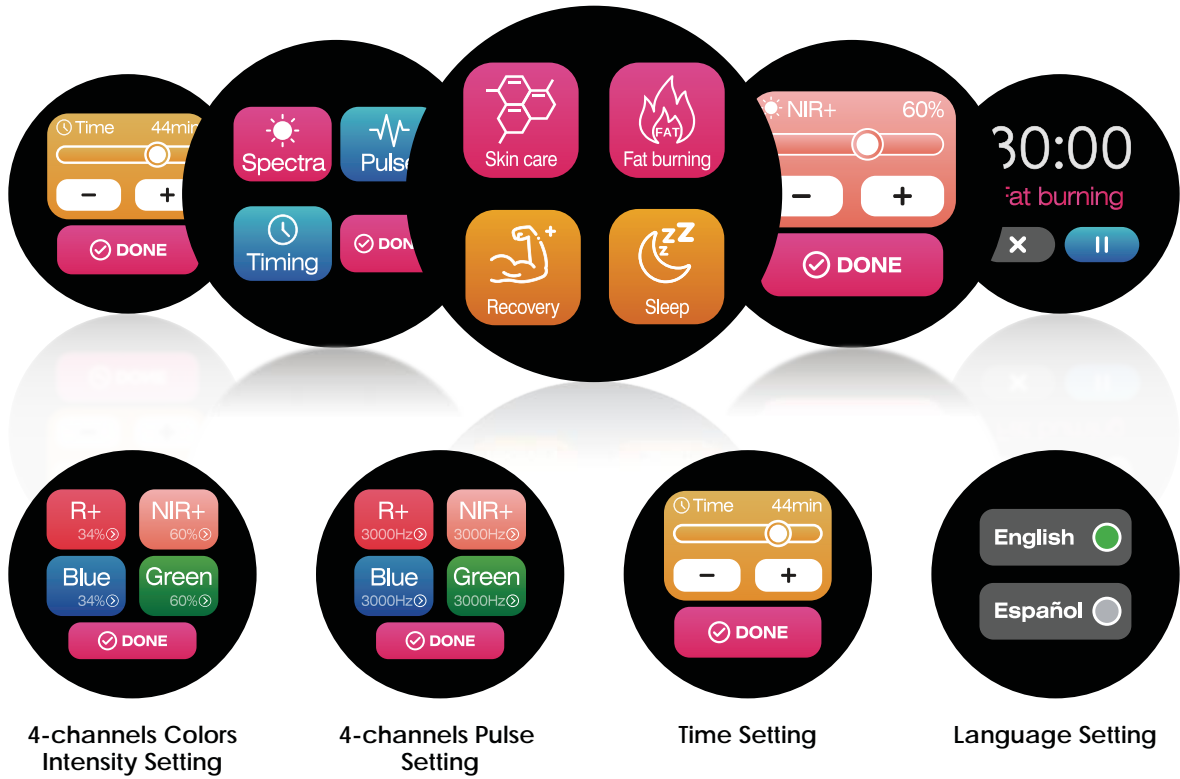

# BIOMOL REMOTE CONTROLLER

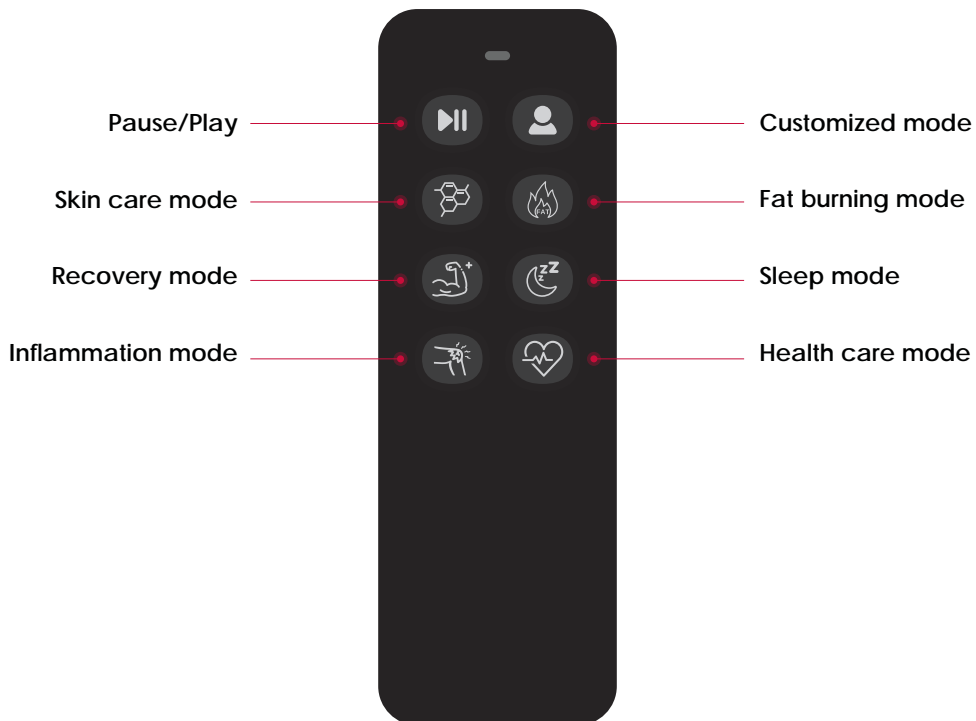

# 4 CHANNELS+7 SPECTRA

Meet different customer needs



Channel 1# RED (630nm+660nm)



Channel 2# NIR (810nm+830nm+850nm)

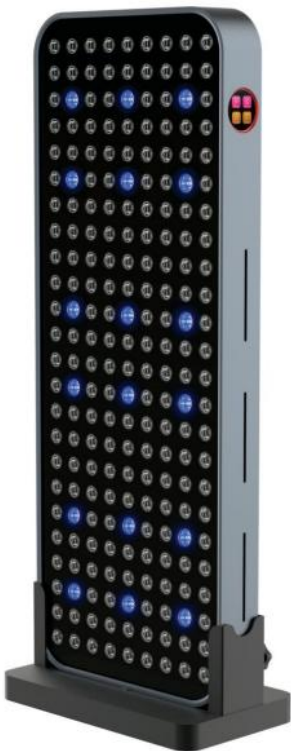

Channel 3# Blue (450nm)

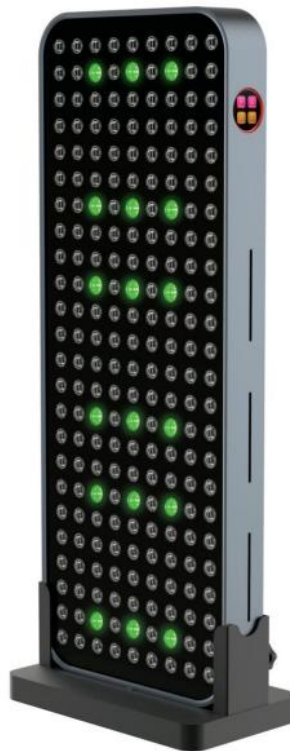

Channel 4# Green (528nm)

# BIOMOL HOUSEHOLD PRO SERIES

## HP360



<b>LEDs:</b>	72x5W 3535 LED
<b>Wavelength:</b>	Channel 1# RED (630nm+660nm) Channel 2# NIR (810nm+830nm+850nm) Channel 3# Blue (450nm) Channel 4# Green (528nm)
<b>Beam angle:</b>	30 degrees
<b>Control way:</b>	Touch screen & Remote controller
<b>Voltage:</b>	AC100-240V
<b>Irradiance:</b>	>580mW/cm <sup>2</sup>
<b>Pulse:</b>	0-3000Hz
<b>Flicker:</b>	Flicker free
<b>EMF:</b>	0.0μt
<b>Use way:</b>	Table stand
<b>Lifespan:</b>	>100,000 Hours
<b>Warranty:</b>	3 Years
<b>Material:</b>	Aluminum
<b>Product size:</b>	300 x 290 x 65mm / 11.8"x 11.4"x 2.6"
<b>Product weight:</b>	4KG/8.8LB
<b>Gross weight:</b>	5KG/11LB
<b>Packing:</b>	380x380x190mm/ 15"x 15"x 7.5"

## HP720



<b>LEDs:</b>	144x5W 3535 LED
<b>Wavelength:</b>	Channel 1# RED (630nm+660nm) Channel 2# NIR (810nm+830nm+850nm) Channel 3# Blue (450nm) Channel 4# Green (528nm)
<b>Beam angle:</b>	30 degrees
<b>Control way:</b>	Touch screen & Remote controller
<b>Voltage:</b>	AC100-240V
<b>Irradiance:</b>	>580mW/cm <sup>2</sup>
<b>Pulse:</b>	0-3000Hz
<b>Flicker:</b>	Flicker free
<b>EMF:</b>	0.0μt
<b>Use way:</b>	Floor stand
<b>Lifespan:</b>	>100,000 Hours
<b>Warranty:</b>	3 Years
<b>Material:</b>	Aluminum
<b>Product size:</b>	530 x 300 x 65mm / 20.9"x 11.8"x 2.6"
<b>Product weight:</b>	7.5KG/16.5LB
<b>Gross weight:</b>	8.5KG/18.74LB
<b>Packing:</b>	610x390x170mm/ 24"x 15.4"x 6.7"

# BIOMOL HOUSEHOLD PRO SERIES

## HP1080

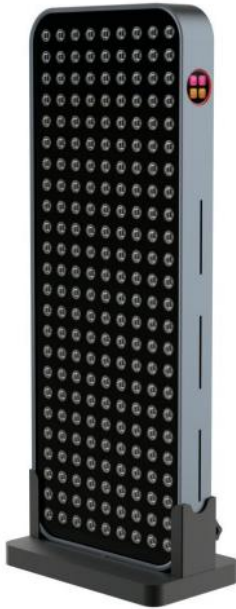

<b>LEDs:</b>	216x5W 3535 LED
<b>Wavelength:</b>	Channel 1# RED (630nm+660nm)
	Channel 2# NIR (810nm+830nm+850nm)
	Channel 3# Blue (450nm)
	Channel 4# Green (528nm)
<b>Beam angle:</b>	30 degrees
<b>Control way:</b>	Touch screen & Remote controller
<b>Voltage:</b>	AC100-240V
<b>Irradiance:</b>	>580mW/cm <sup>2</sup>
<b>Pulse:</b>	0-3000Hz
<b>Flicker:</b>	Flicker free
<b>EMF:</b>	0.0μt
<b>Use way:</b>	Floor stand
<b>Lifespan:</b>	>100,000 Hours
<b>Warranty:</b>	3 Years
<b>Material:</b>	Aluminum
<b>Product size:</b>	770 x 300 x 65mm / 30.3"x 11.8"x 2.6"
<b>Product weight:</b>	10KG/22LB
<b>Gross weight:</b>	11KG/24.3LB
<b>Packing:</b>	850x390x180mm/ 33.5"x 15.4"x 7"

## HP1440



<b>LEDs:</b>	288x5W 3535 LED
<b>Wavelength:</b>	Channel 1# RED (630nm+660nm)
	Channel 2# NIR (810nm+830nm+850nm)
	Channel 3# Blue (450nm)
	Channel 4# Green (528nm)
<b>Beam angle:</b>	30 degrees
<b>Control way:</b>	Touch screen & Remote controller
<b>Voltage:</b>	AC100-240V
<b>Irradiance:</b>	>580mW/cm <sup>2</sup>
<b>Pulse:</b>	0-3000Hz
<b>Flicker:</b>	Flicker free
<b>EMF:</b>	0.0μt
<b>Use way:</b>	Floor stand
<b>Lifespan:</b>	>100,000 Hours
<b>Warranty:</b>	3 Years
<b>Material:</b>	Aluminum
<b>Product size:</b>	1010 x 300 x 65mm / 39.8" x 11.8" x 2.6"
<b>Product weight:</b>	12KG/26.5LB
<b>Gross weight:</b>	14KG/30.86LB
<b>Packing:</b>	1190x390x190mm/ 46.9"x 15.4"x 7.5"





## HP1800

<b>LEDs:</b>	360x5W 3535 LED
<b>Wavelength:</b>	Channel 1# RED (630nm+660nm)
	Channel 2# NIR (810nm+830nm+850nm)
	Channel 3# Blue (450nm)
	Channel 4# Green (528nm)
<b>Beam angle:</b>	30 degrees
<b>Control way:</b>	Touch screen & Remote controller
<b>Voltage:</b>	AC100-240V
<b>Irradiance:</b>	>590mW/cm <sup>2</sup>
<b>Pulse:</b>	0-3000Hz
<b>Flicker:</b>	Flicker free
<b>EMF:</b>	0.0μt
<b>Use way:</b>	Floor stand
<b>Lifespan:</b>	>100,000 Hours
<b>Warranty:</b>	3 Years
<b>Material:</b>	Aluminum
<b>Product size:</b>	1250 x 300 x 65mm / 49.2"x 11.8" x 2.6"
<b>Product weight:</b>	14KG/30.8LB
<b>Gross weight:</b>	16KG/35.27LB
<b>Packing:</b>	1340x400x190mm/ 52.3"x 15.8"x 7.5"

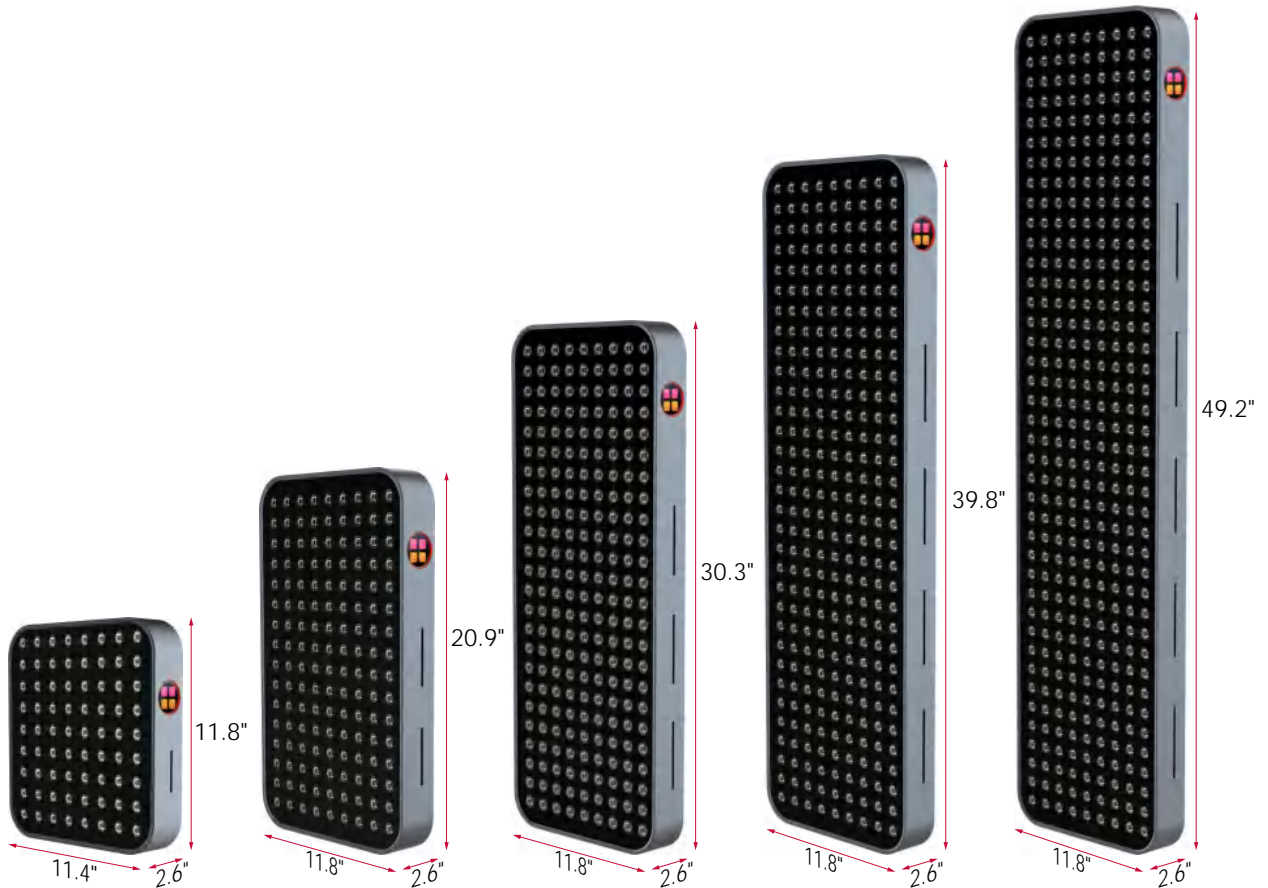

# STAND

## 1. Table top stand (only for HP360)



## 2. Folding floor stand (for HP720/HP1080/HP1440/HP1800)

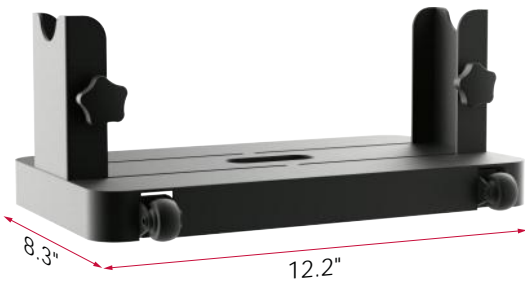

Folding floor stand 2 wheels  
(Standard)

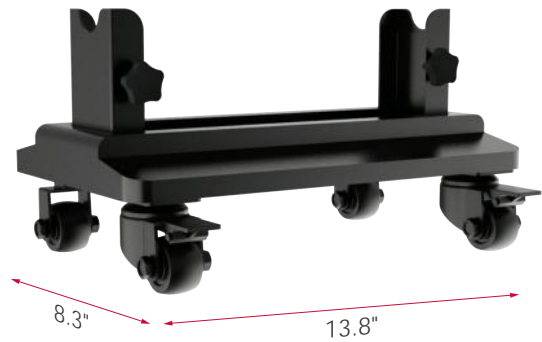

Folding floor stand 4 wheels  
(Optional)

# PACKAGE CONTENTS

- BioMol LED red light therapy panel x 1
- BioMol remote controller x 1
- Power cable x 1
- Readable glasses x 1
- Stand x 1
- BioMol user manual x 1

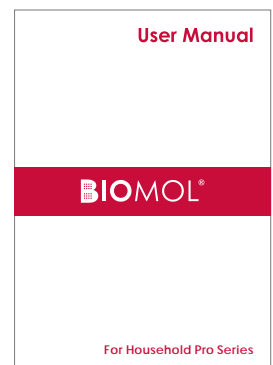
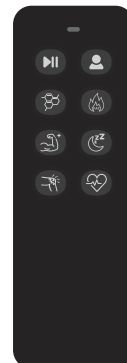

**BIOMOL®**

# BEAUTY MEDICAL SERIES LED RED LIGHT THERAPY



Specially designed for professional beauty & medical treatment. Exquisite appearance, rich functions.

Integrated module lens & center dual-LED design, super high irradiance value.

Intelligent touch screen, and voice control, built-in and Bluetooth music, providing high-end quality enjoyment.

For both full body & half body therapy, matching manual or electric adjustable stand.

Just enjoy it!



6 Default Modes  
+3 Customized Modes



3 Channels  
+7 Spectra



Dual LEDs



Voice Control



Touch Screen



Bluetooth



Blue light





⚠ Please wear glasses or close eyes when enjoying therapy.

# VOICE CONTROL SYSTEM

Respond immediately and start your exclusive care mode remotely

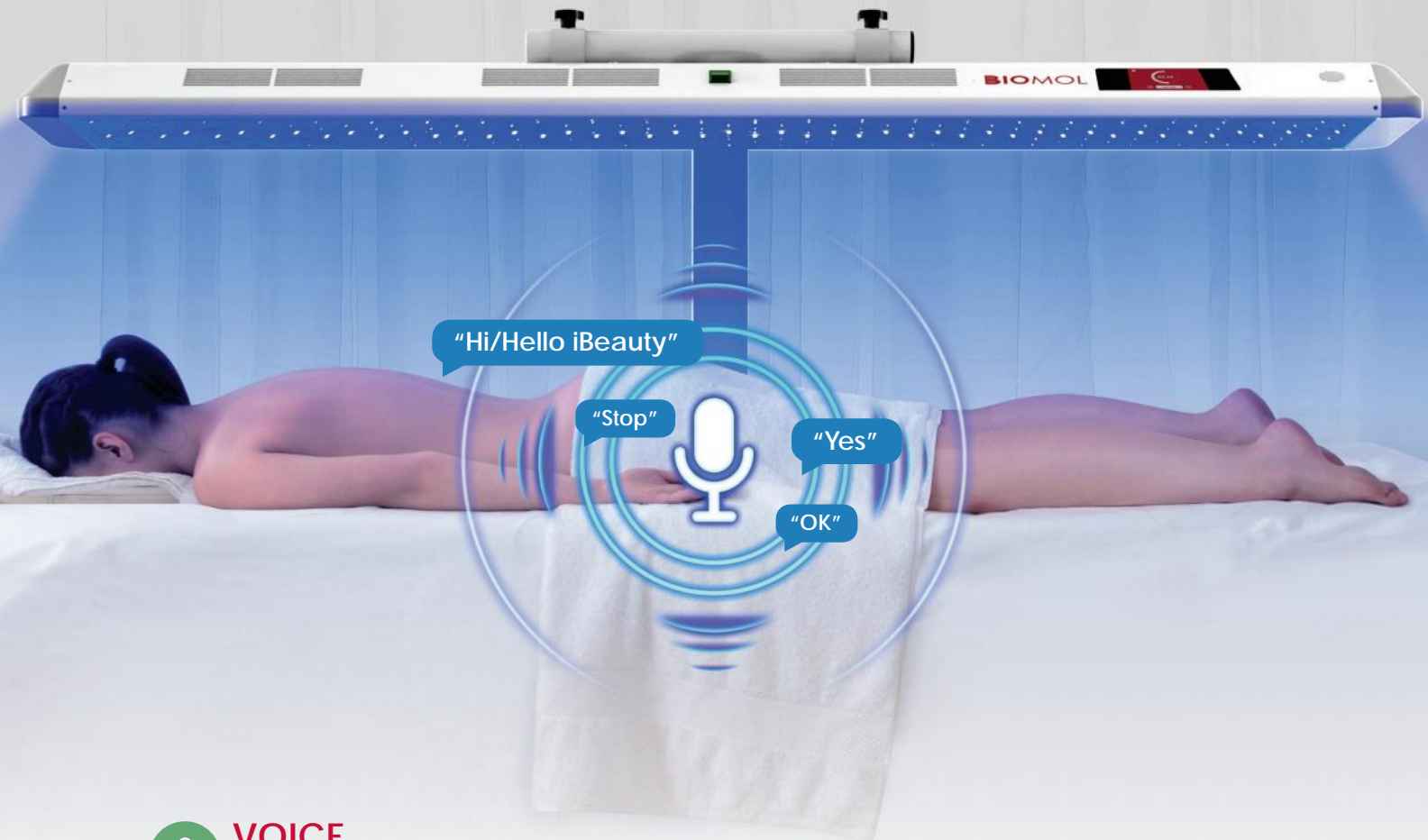

## VOICE

Turn on/off the voice control function

### Voice Settings

Wake-up: Hi/Hello iBeauty

C: Run Skin care mode

C: Run Acne mode

C: Run Fat burning mode

C: Run Hair Care mode

C: Run Relax mode

C: Run Sleep mode

C: Run mode 1/2/3

C: Stop

C: Volume up/down

C: Turn on/off Bluetooth

R: Yes (Valid for 15s)

R: OK, Skin care mode is on

R: OK, Acne mode is on

R: OK, Fat burning mode is on

R: OK, Hair Care mode is on

R: OK, Relax mode is on

R: OK, Sleep mode is on

R: OK, mode 1/2/3 is on

R: OK

R: OK (10% each order)

R: Ok

# 3 CHANNELS+7 SPECTRA

Meet different customer needs

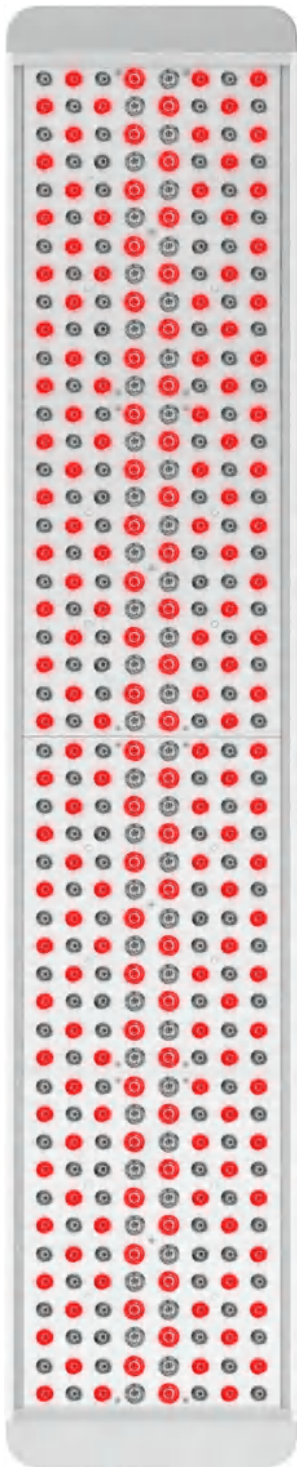

Channel 1# RED  
(610nm+630nm+660nm)

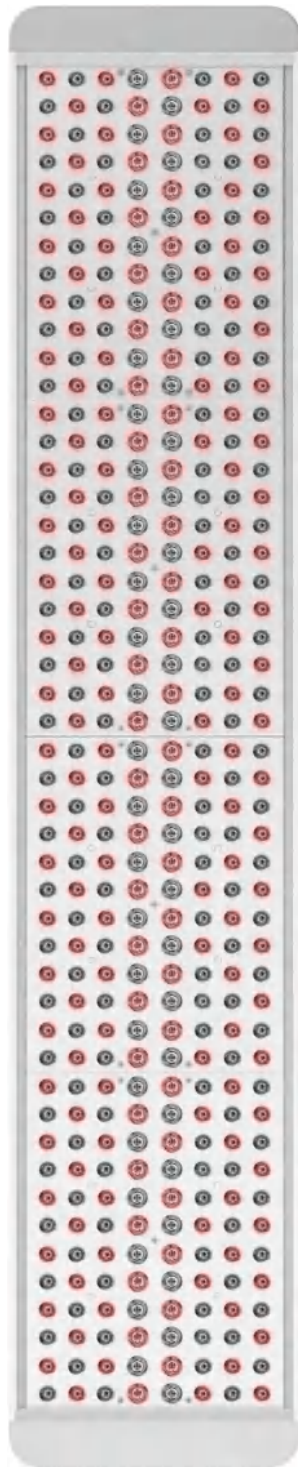

Channel 2# NIR  
(810nm+830nm+850nm)

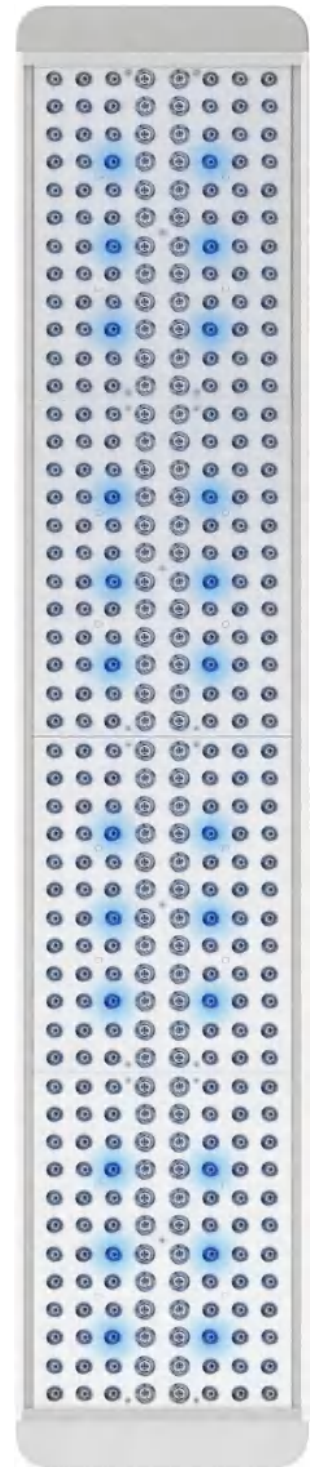

Channel 3# Blue  
(450nm)

# BIOMOL TOUCH SCREEN

3.5 inch high-definition touch display  
6 Default modes + 3 customized modes

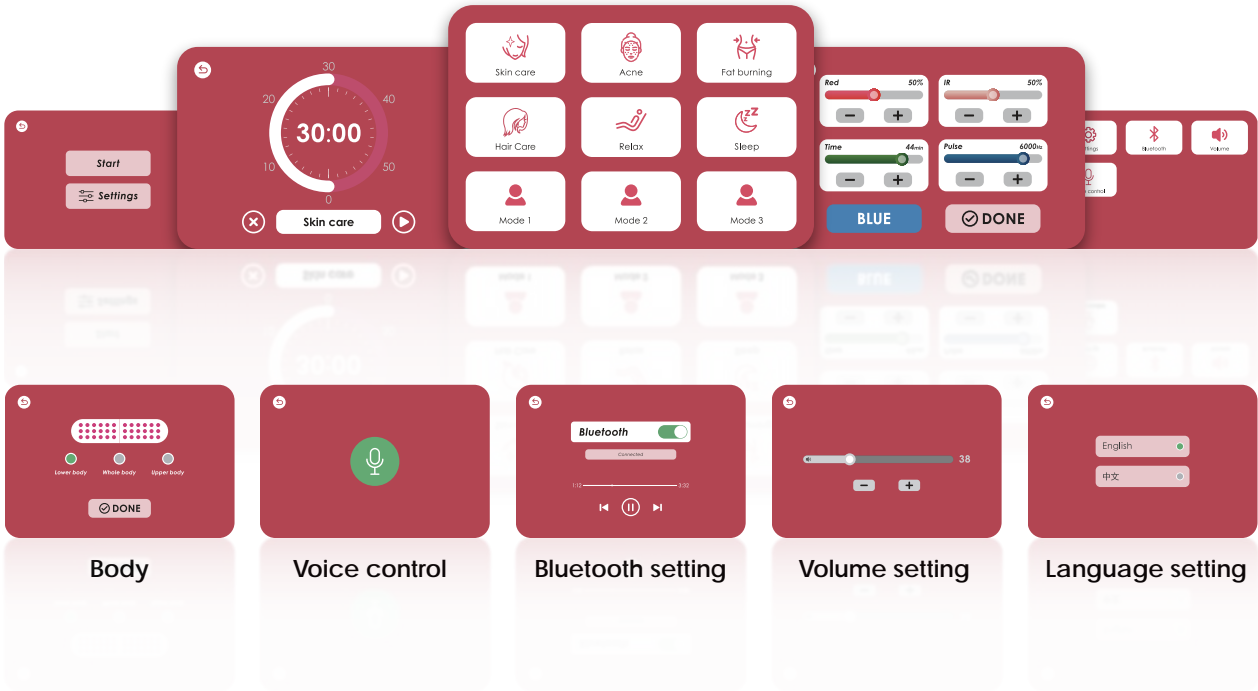

# IRRADIANCE TEST

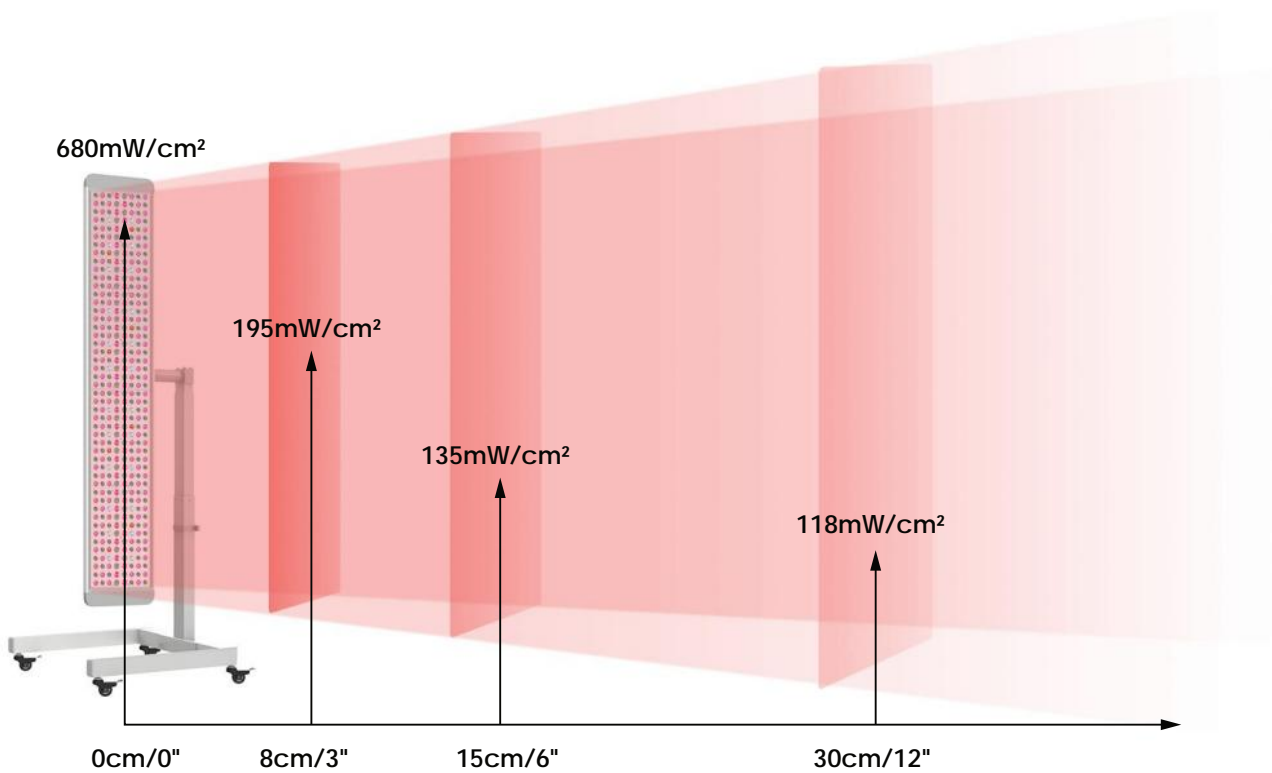

# BIOMOL BEAUTY MEDICAL SERIES

## BM-Beauty

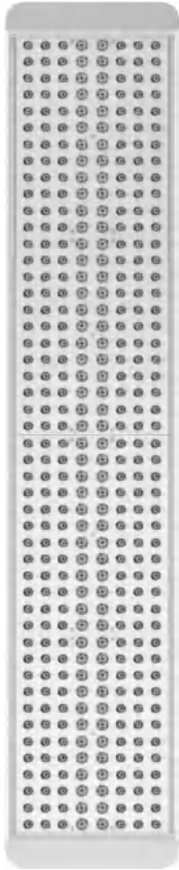

<b>LEDs:</b>	480 x 5W 3535 LED
<b>Wavelength:</b>	Channel 1# RED (610nm+630nm+660nm)
	Channel 2# NIR (810nm+830nm+850nm)
	Channel 3# Blue (450nm)
<b>Beam angle:</b>	15/30/60 mixed degrees
<b>Control way:</b>	Touch screen & Voice control
<b>Voltage:</b>	AC85-240V
<b>Irradiance:</b>	>680mW/cm <sup>2</sup>
<b>Pulse:</b>	0-9,999Hz
<b>Flicker:</b>	Flicker free
<b>EMF:</b>	0.0μt
<b>Use way:</b>	Horizontal & Vertical stand
<b>Lifespan:</b>	>100,000 Hours
<b>Warranty:</b>	3 Years
<b>Material:</b>	Iron
<b>Product size:</b>	1635 x 300 x 75mm / 64.3" x 11.8" x 3"
<b>Product weight:</b>	18KG/39.6LB
<b>Gross weight:</b>	22KG/48.5LB
<b>Packing:</b>	1720 x 340 x 115mm / 68" x 13" x 4.5"

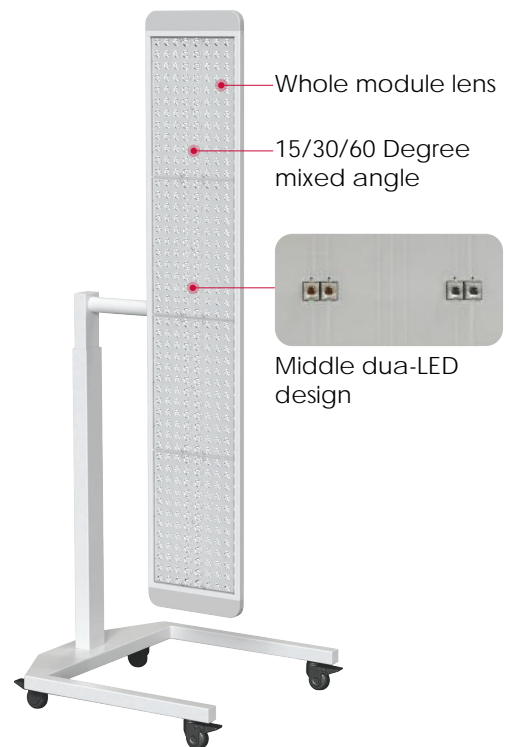



# OPTIONAL STAND

## 1. Electric Horizontal & Vertical Stand

Use wired or wireless remote controller to adjust the height of the stand.



Remote controller



Wired controller

## 2. Manual Horizontal & Vertical Stand



# PACKAGE CONTENTS

- BioMol Beauty device x 1
- Glasses X 1
- Goggles X1
- Power cable x 1
- Biomol user manual x 1

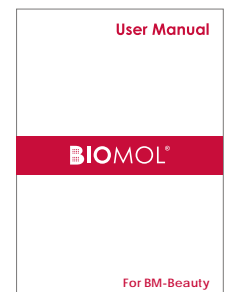

**BIOMOL®**

# FITNESS SERIES

# LED RED LIGHT THERAPY



Experience the ultimate fitness lighting solution with the Fitness Series, designed to elevate workout routine and support fitness goals. This cutting-edge product is perfect for gyms, fitness studios, and wellness centers, catering to both professional trainers and fitness enthusiasts.

By incorporating specific wavelengths, the Fitness Series helps athletes and fitness enthusiasts achieve peak performance. The emitted light stimulates energy production, leading to increased endurance and improved workout efficiency.

The Fitness Series provide an exceptional fitness environment that promotes productivity, enhance energy and accelerate recovery.

Just enjoy it!



4 Default modes  
+3 Customized mode



3 Channels  
+7 Spectra



All 3535 5W LEDs



Touch Screen



Remote  
Controller



Blue light

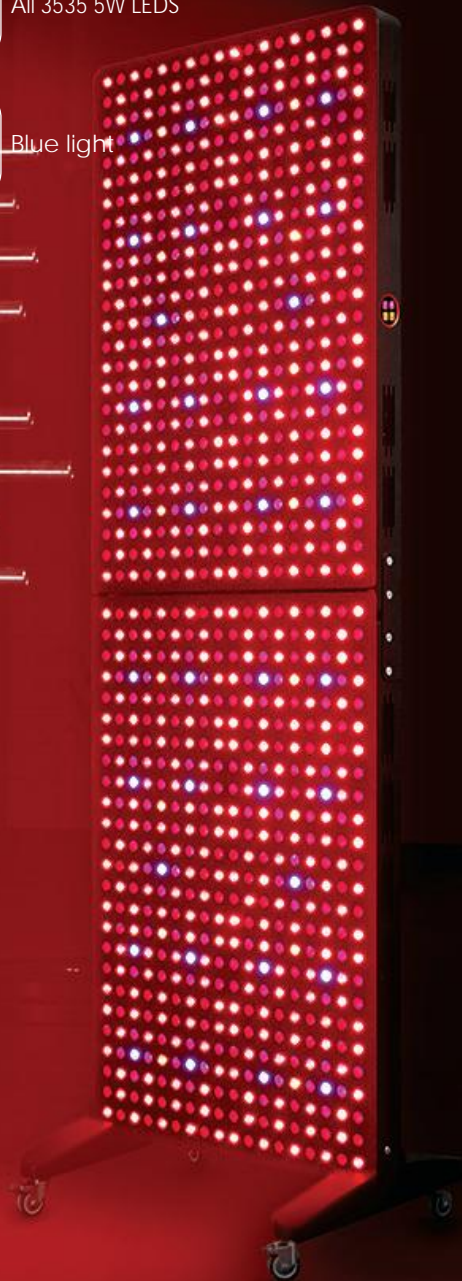

BioMol Fitness Series



⚠ Please wear glasses or close eyes when enjoying therapy.

# BIOMOL TOUCH SCREEN

4 Default modes + 3 Customized mode

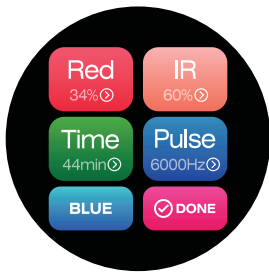

Setting



Time Setting

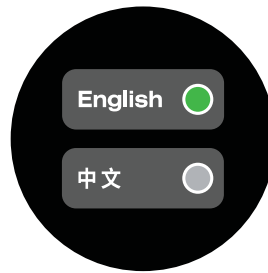

Language Setting

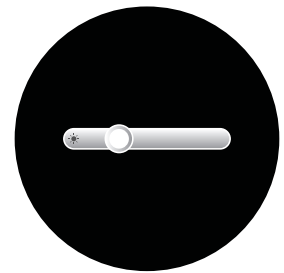

Brightness Setting

# BIOMOL REMOTE CONTROLLER

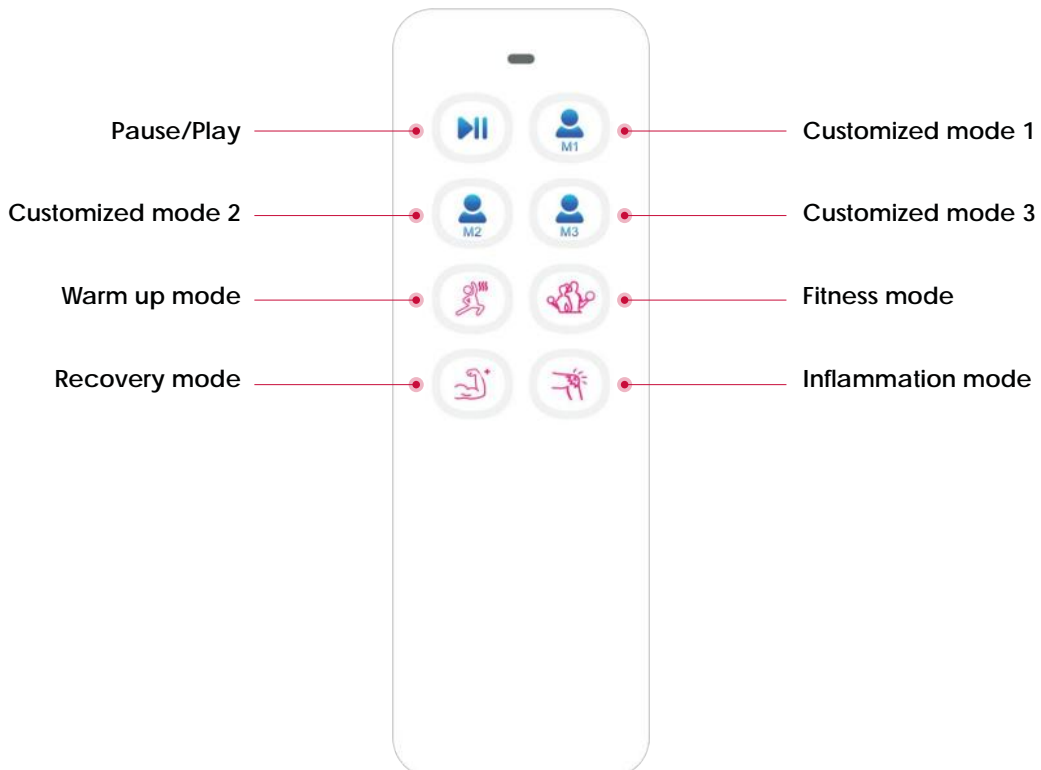

# 3 CHANNELS+7 SPECTRA

Meet different customer needs

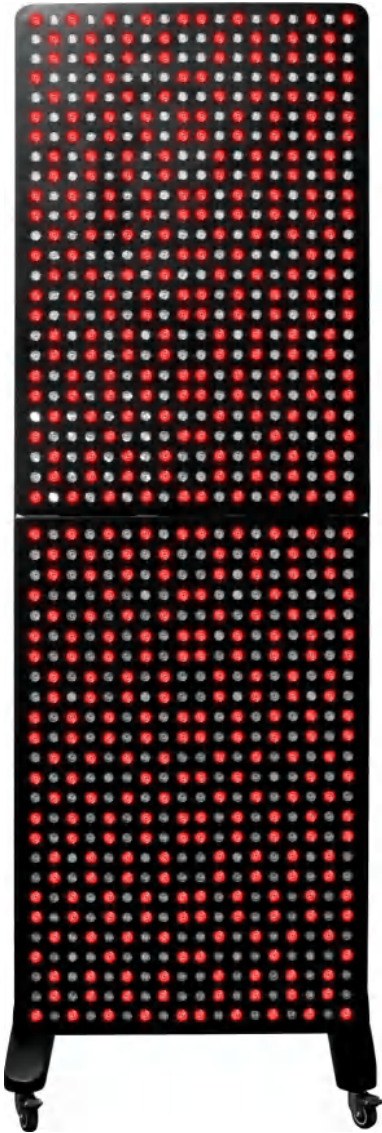

Channel 1# RED  
(610nm+630nm+660nm)

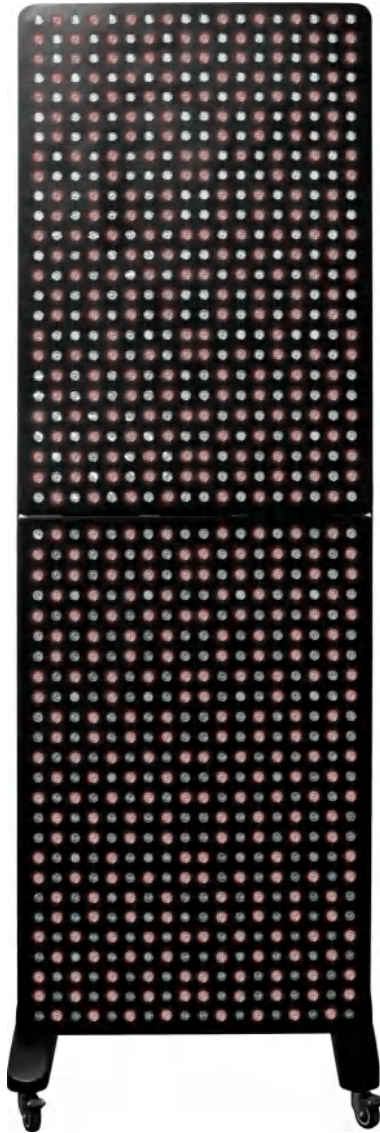

Channel 2# NIR  
(810nm+830nm+850nm)

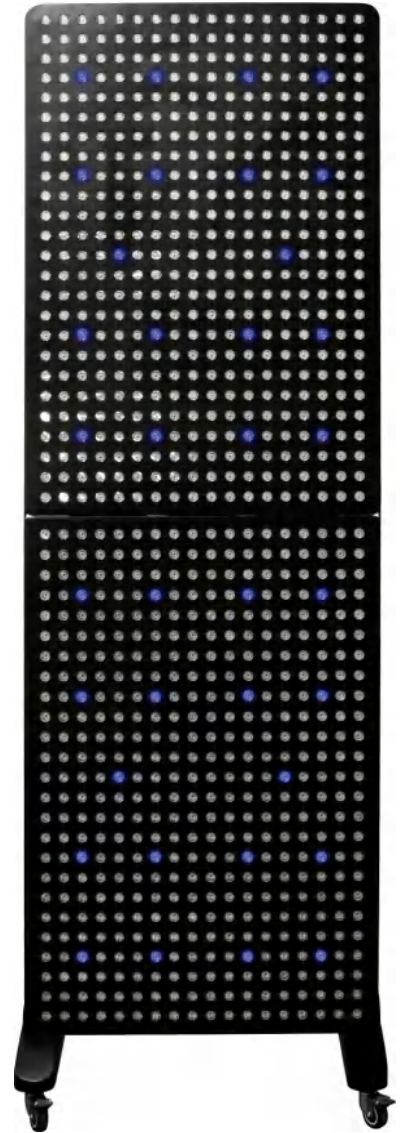

Channel 3# Blue  
(450nm)

# BIOMOL FITNESS SERIES

## BM-Fitness

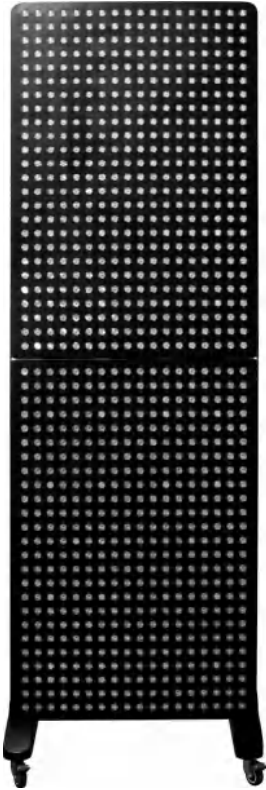

LEDs:	900 x 5W 3535 LED
Wavelength:	Channel 1# RED (610nm+630nm+660nm)
	Channel 2# NIR (810nm+830nm+850nm)
	Channel 3# Blue (450nm)
Beam angle:	30 degrees
Control way:	Touch screen & Remote controller
Voltage:	AC100-240V
Irradiance:	>720mW/cm <sup>2</sup>
Pulse:	0-9,999Hz
Flicker:	Flicker free
EMF:	0.0µt
Use way:	Floor stand
Lifespan:	>100,000 Hours
Warranty:	3 Years
Material:	Iron
Product size:	1900 x 600 x 70mm / 75" x 24" x 2.7"
Product weight:	50KG/110.2LB
Gross weight:	58KG/127.8LB
Packing:	2 x (1190 x 720 x 190mm) 1pc / 2 x (46.9" x 28.3" x 7.5")

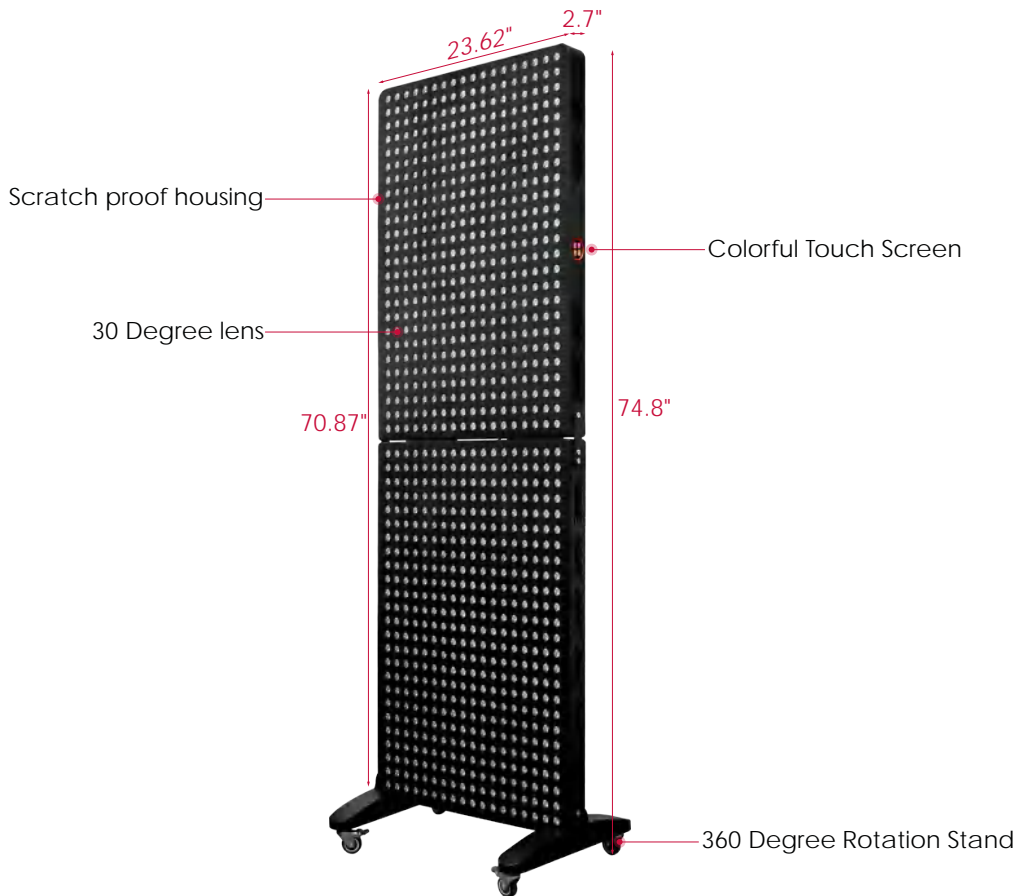

# IRRADIANCE TEST

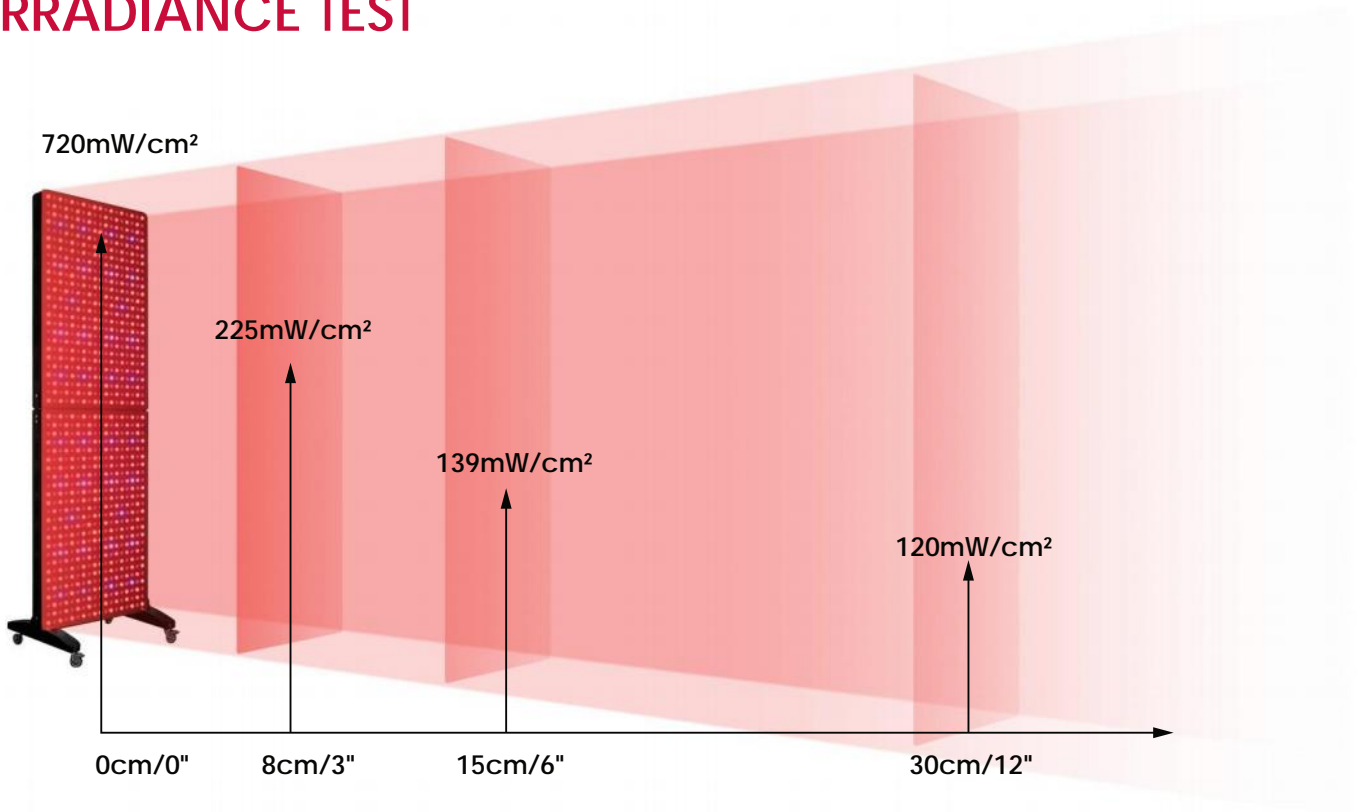

# PACKAGE CONTENTS

- BioMol LED red light therapy panel x 1
- Biomol remote controller x 1
- Readable glasses x 1
- Floor stand x 1
- Power cable x 1
- Biomol user manual x 1



**BIOMOL<sup>®</sup>**

**RP SERIES**

# LED RED LIGHT THERAPY



No need any appointment to beauty salons or health treatment clubs, the path to beauty and wellness can be traversed within the confines of your own home, at your convenience.

BioMol's advanced RP series offers both half-body and full-body therapy, providing a holistic approach to health and vitality. With 6 default modes and 1 customizable mode, you can enjoy a seamless experience without the hassle of constant adjustments.

Our innovative dual-mode touch keys and remote controller allow you to effortlessly manage the device from a distance, ensuring simplicity and control at your fingertips. Embrace this transformative experience and enjoy the remarkable benefits it brings!



6 Default Modes  
+1 Customized Mode



4 Channels + 7 Spectra



All 3535 5w LEDs



Touch Screen



Remote Controller

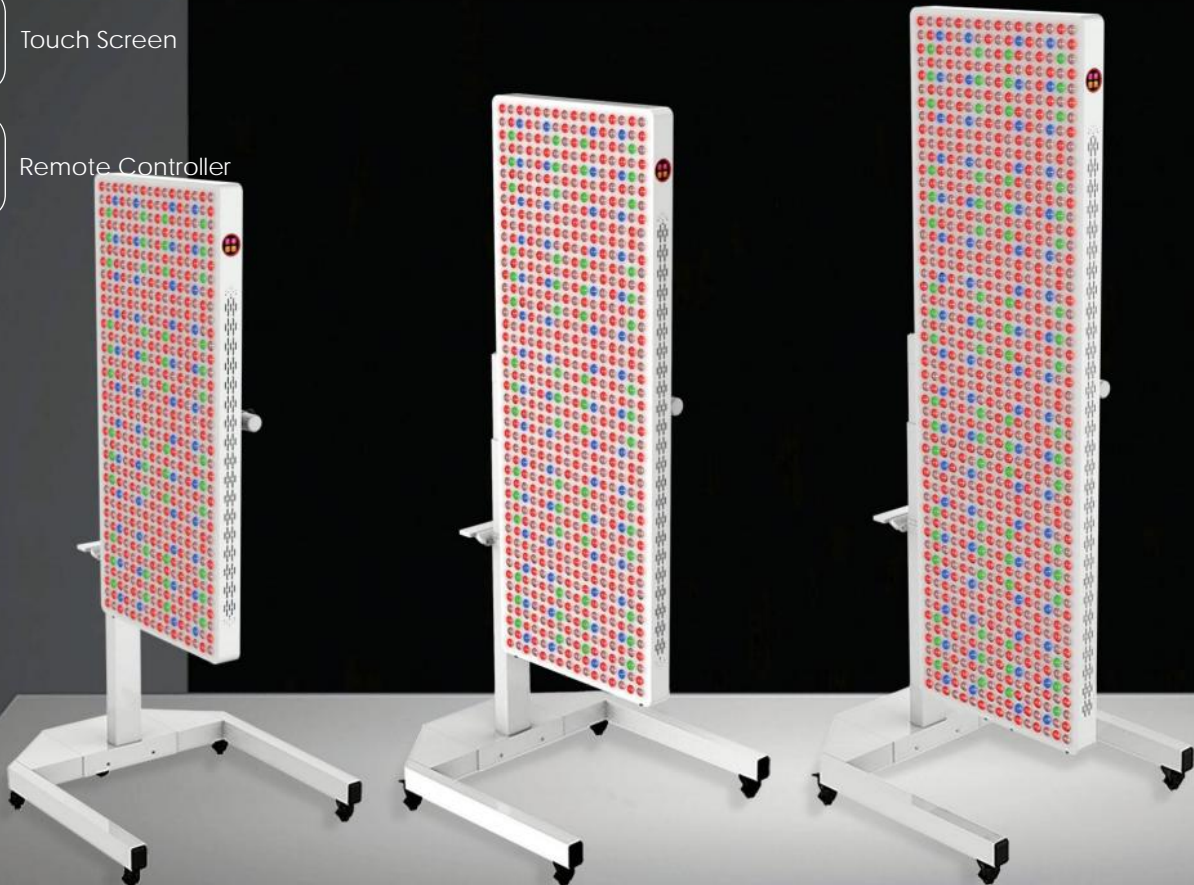
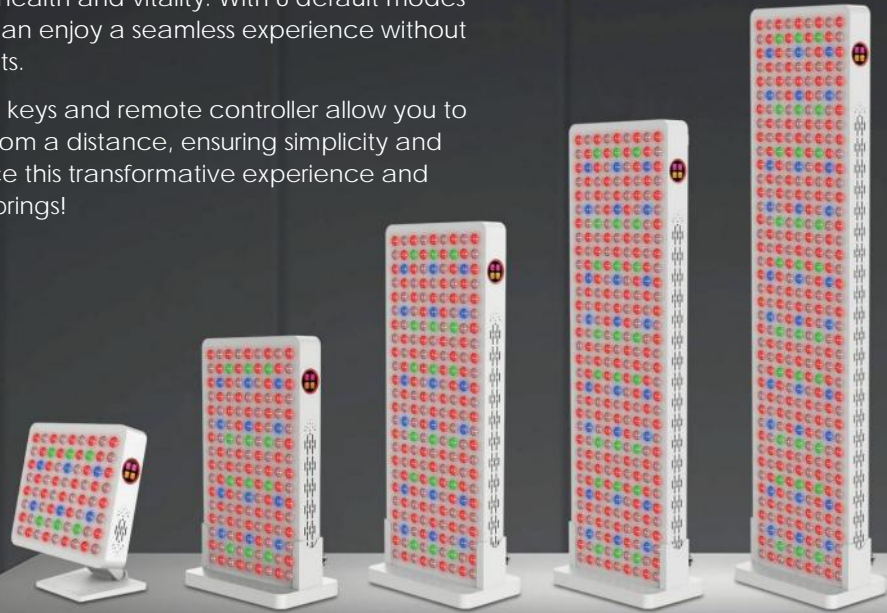



BioMol RP Series



⚠ Please wear glasses or close eyes when enjoying therapy.

# BIOMOL TOUCH SCREEN

6 Default modes + 1 Customized mode



# BIOMOL REMOTE CONTROLLER

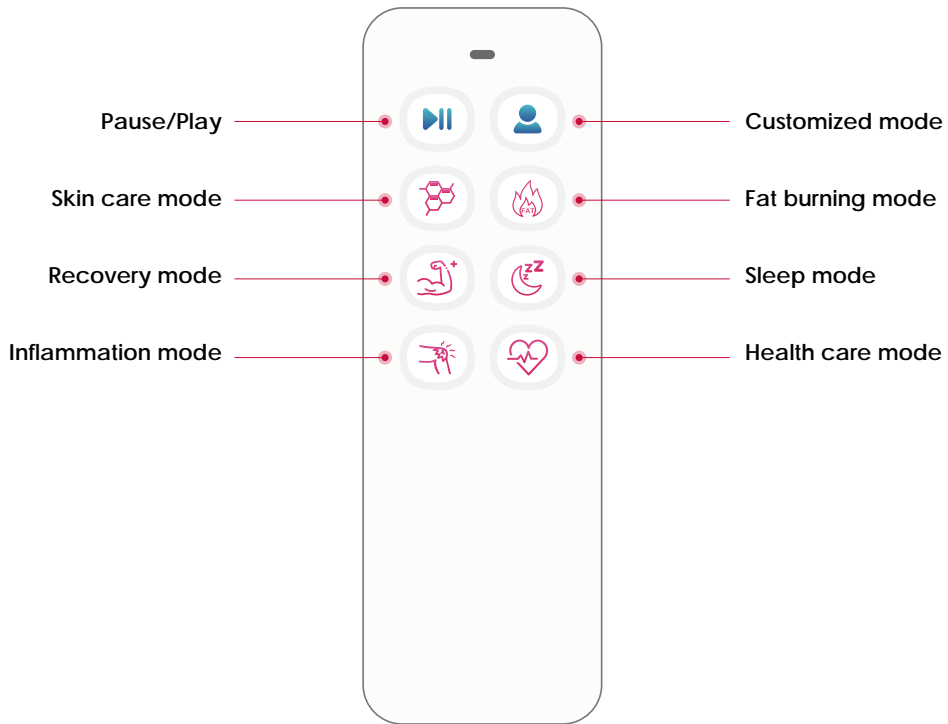

# 4 CHANNELS+7 SPECTRA

Meet different customer needs

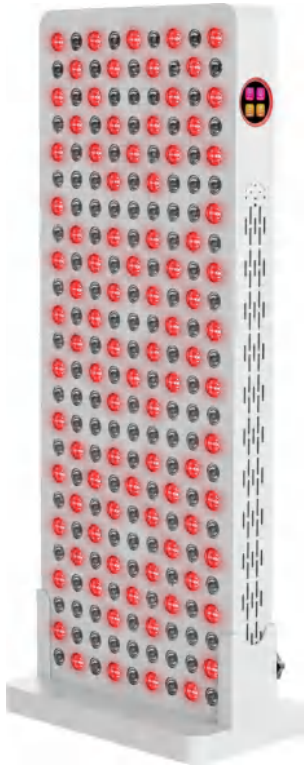

Channel 1# RED (630nm+660nm)



Channel 2# NIR (810nm+830nm+850nm)

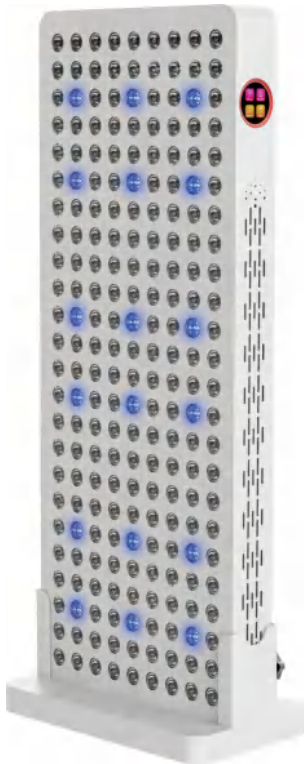

Channel 3# Blue (450nm)



Channel 4# Green (528nm)

# BIOMOL RP SERIES

## RP360Z



<b>LEDs:</b>	72x5W 3535 LED
<b>Wavelength:</b>	Channel 1# RED (630nm+660nm)
	Channel 2# NIR (850nm+830nm+810nm)
	Channel 3# Blue (450nm)
	Channel 4# Green (528nm)
<b>Beam angle:</b>	30 degrees
<b>Control way:</b>	Touch screen & Remote controller
<b>Voltage:</b>	AC85-240V
<b>Irradiance:</b>	>520mw/cm <sup>2</sup>
<b>Pulse:</b>	0-5000Hz
<b>Flicker:</b>	Flicker free
<b>EMF:</b>	0.0μt
<b>Use way:</b>	Table stand
<b>Lifespan:</b>	>100,000 Hours
<b>Warranty:</b>	3 Years
<b>Material:</b>	Iron
<b>Product size:</b>	300x300x60mm / 12"x12"x2.4"
<b>Product weight:</b>	5KG/11LB
<b>Gross weight:</b>	5.5KG/12.1LB

## RP720Z



<b>LEDs:</b>	144x5W 3535 LED
<b>Wavelength:</b>	Channel 1# RED (630nm+660nm)
	Channel 2# NIR (850nm+830nm+810nm)
	Channel 3# Blue (450nm)
	Channel 4# Green (528nm)
<b>Beam angle:</b>	30 degrees
<b>Control way:</b>	Touch screen & Remote controller
<b>Voltage:</b>	AC85-240V
<b>Irradiance:</b>	>580mw/cm <sup>2</sup>
<b>Pulse:</b>	0-5000Hz
<b>Flicker:</b>	Flicker free
<b>EMF:</b>	0.0μt
<b>Use way:</b>	Multiple stands
<b>Lifespan:</b>	>100,000 Hours
<b>Warranty:</b>	3 Years
<b>Material:</b>	Iron
<b>Product size:</b>	520x300x60mm / 20.5"x12"x2.4"
<b>Product weight:</b>	8KG/17.6LB
<b>Gross weight:</b>	10.5KG/23.2LB

# BIOMOL RP SERIES

## RP1080Z

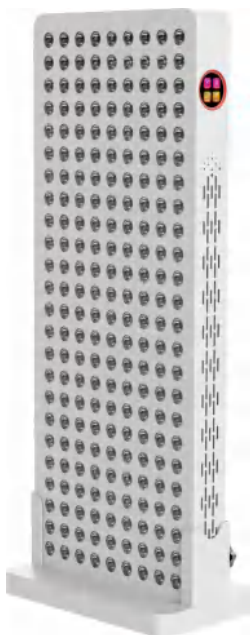

LEDs:	216x5W 3535 LED
Wavelength:	Channel 1# RED (630nm+660nm)
	Channel 2# NIR (850nm+830nm+810nm)
	Channel 3# Blue (450nm)
	Channel 4# Green (528nm)
Beam angle:	30 degrees
Control way:	Touch screen & Remote controller
Voltage:	AC85-240V
Irradiance:	>580mw/cm <sup>2</sup>
Pulse:	0-5000Hz
Flicker:	Flicker free
EMF:	0.0μt
Use way:	Multiple stands
Lifespan:	>100,000 Hours
Warranty:	3 Years
Material:	Iron
Product size:	760x300x60mm / 30"x12"x2.4"
Product weight:	11KG/24.3LB
Gross weight:	13.5KG/29.8LB

## RP1440Z

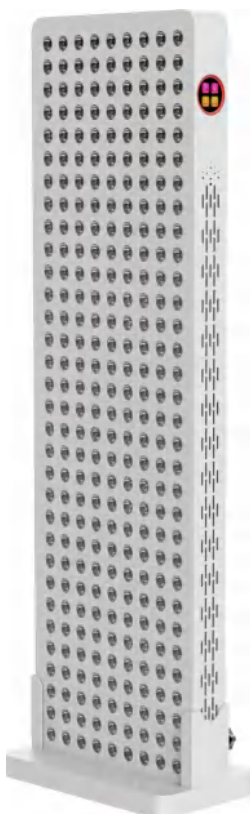

LEDs:	288x5W 3535 LED
Wavelength:	Channel 1# RED (630nm+660nm)
	Channel 2# NIR (850nm+830nm+810nm)
	Channel 3# Blue (450nm)
	Channel 4# Green (528nm)
Beam angle:	30 degrees
Control way:	Touch screen & Remote controller
Voltage:	AC85-240V
Irradiance:	>580mw/cm <sup>2</sup>
Pulse:	0-5000Hz
Flicker:	Flicker free
EMF:	0.0μt
Use way:	Multiple stands
Lifespan:	>100,000 Hours
Warranty:	3 Years
Material:	Iron
Product size:	1000x300x60mm / 39.3"x12"x2.4"
Product weight:	12.5KG/27.6LB
Gross weight:	14.5KG/32LB
Packing:	1100x390x180mm/ 43.3"x15.4"x7"

# BIOMOL RP SERIES

## RP1800Z

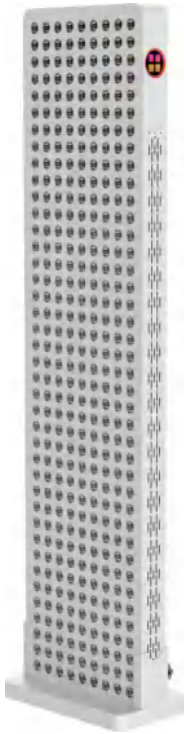

<b>LEDs:</b>	360x5W 3535 LED
<b>Wavelength:</b>	Channel 1# RED (630nm+660nm)
	Channel 2# NIR (850nm+830nm+810nm)
	Channel 3# Blue (450nm)
	Channel 4# Green (528nm)
<b>Beam angle:</b>	30 degrees
<b>Control way:</b>	Touch screen & Remote controller
<b>Voltage:</b>	AC85-240V
<b>Irradiance:</b>	>590mw/cm <sup>2</sup>
<b>Pulse:</b>	0-5000Hz
<b>Flicker:</b>	Flicker free
<b>EMF:</b>	0.0μt
<b>Use way:</b>	Multiple stands
<b>Lifespan:</b>	>100,000 Hours
<b>Warranty:</b>	3 Years
<b>Material:</b>	Iron
<b>Product size:</b>	1240x300x60mm / 48.8"x12"x2.4"
<b>Product weight:</b>	17KG/37.5LB
<b>Gross weight:</b>	20KG/44.1LB

## RP2800Z



<b>LEDs:</b>	576x5W 3535 LED
<b>Wavelength:</b>	Channel 1# RED (630nm+660nm)
	Channel 2# NIR (850nm+830nm+810nm)
	Channel 3# Blue (450nm)
	Channel 4# Green (528nm)
<b>Beam angle:</b>	30 degrees
<b>Control way:</b>	Touch screen & Remote controller
<b>Voltage:</b>	AC85-240V
<b>Irradiance:</b>	> 600mw/cm <sup>2</sup>
<b>Pulse:</b>	0-5000Hz
<b>Flicker:</b>	Flicker free
<b>EMF:</b>	0.0μt
<b>Use way:</b>	Multiple stands
<b>Lifespan:</b>	>100,000 Hours
<b>Warranty:</b>	3 Years
<b>Material:</b>	Iron
<b>Product size:</b>	1110x520x60mm / 43.3"x20.5"x2.4"
<b>Product weight:</b>	28KG/61.7LB
<b>Gross weight:</b>	30KG/66.1LB

# BIOMOL RP SERIES

## RP3600Z

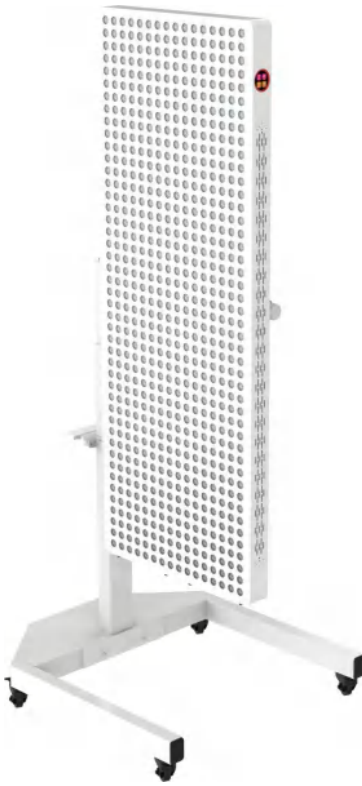

<b>LEDs:</b>	720x5W 3535 LED
<b>Wavelength:</b>	Channel 1# RED (630nm+660nm) Channel 2# NIR (850nm+830nm+810nm) Channel 3# Blue (450nm) Channel 4# Green (528nm)
<b>Beam angle:</b>	30 degrees
<b>Control way:</b>	Touch screen & Remote controller
<b>Voltage:</b>	AC85-240V
<b>Irradiance:</b>	> 600mw/cm <sup>2</sup>
<b>Pulse:</b>	0-5000Hz
<b>Flicker:</b>	Flicker free
<b>EMF:</b>	0.0μt
<b>Use way:</b>	Multiple stands
<b>Lifespan:</b>	>100,000 Hours
<b>Warranty:</b>	3 Years
<b>Material:</b>	Iron
<b>Product size:</b>	1380x520x60mm / 54.3"x20.5"x2.4"
<b>Product weight:</b>	33KG/72.8LB
<b>Gross weight:</b>	36KG/79.4LB

## RP4320Z

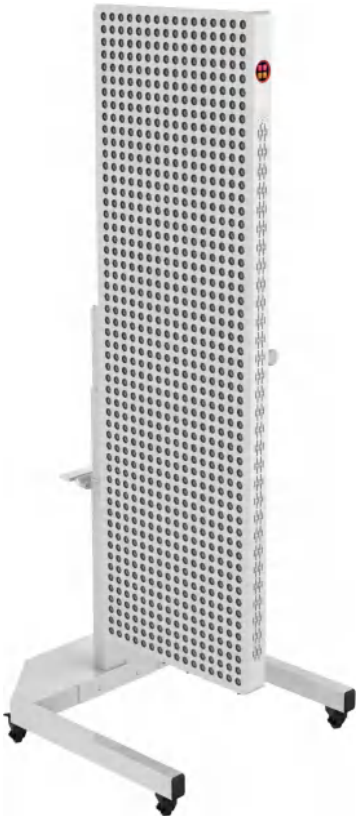

<b>LEDs:</b>	864x5W 3535 LED
<b>Wavelength:</b>	Channel 1# RED (630nm+660nm) Channel 2# NIR (850nm+830nm+810nm) Channel 3# Blue (450nm) Channel 4# Green (528nm)
<b>Beam angle:</b>	30 degrees
<b>Control way:</b>	Touch screen & Remote controller
<b>Voltage:</b>	AC85-240V
<b>Irradiance:</b>	> 600mw/cm <sup>2</sup>
<b>Pulse:</b>	0-5000Hz
<b>Flicker:</b>	Flicker free
<b>EMF:</b>	0.0μt
<b>Use way:</b>	Multiple stands
<b>Lifespan:</b>	>100,000 Hours
<b>Warranty:</b>	3 Years
<b>Material:</b>	Iron
<b>Product size:</b>	1650x520x60mm/65"x20.5"x2.4"
<b>Product weight:</b>	39KG/86LB
<b>Gross weight:</b>	42KG/92.6LB

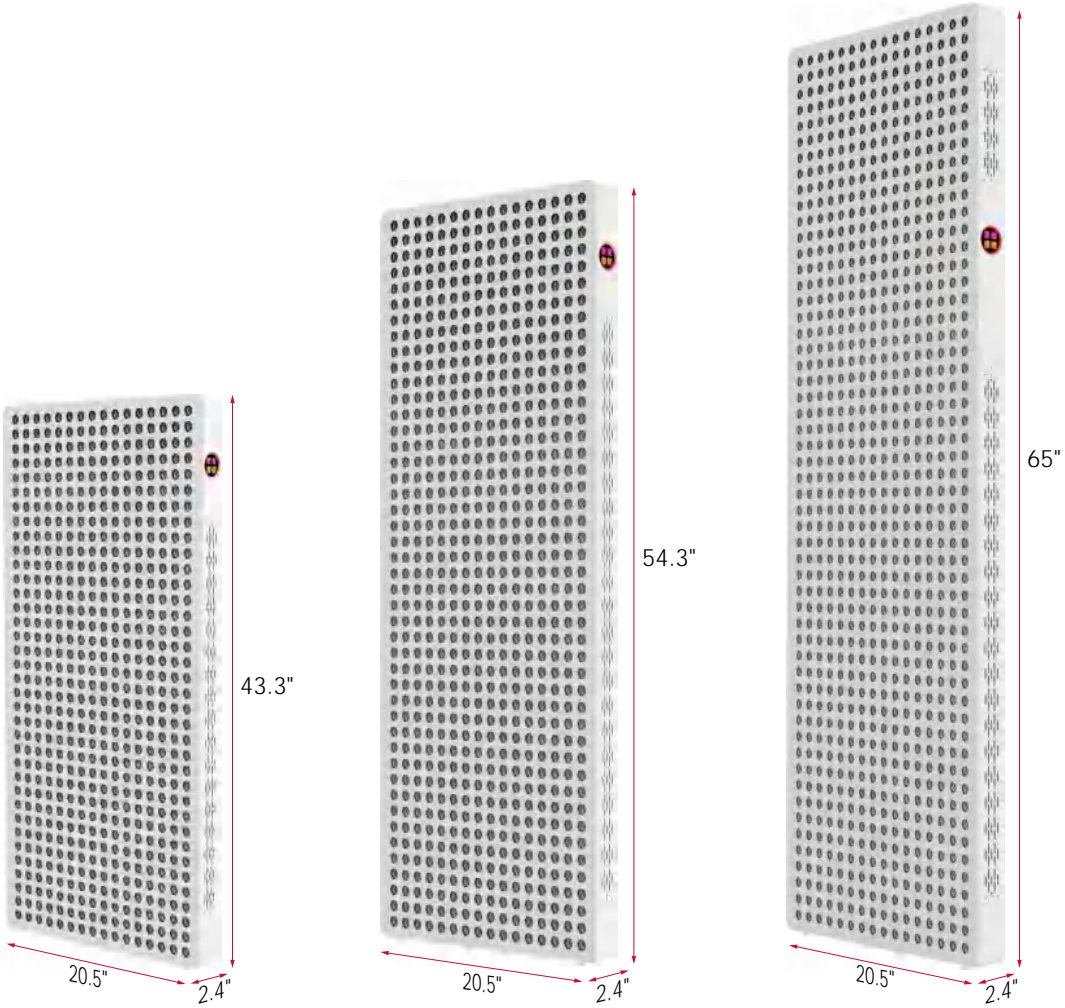
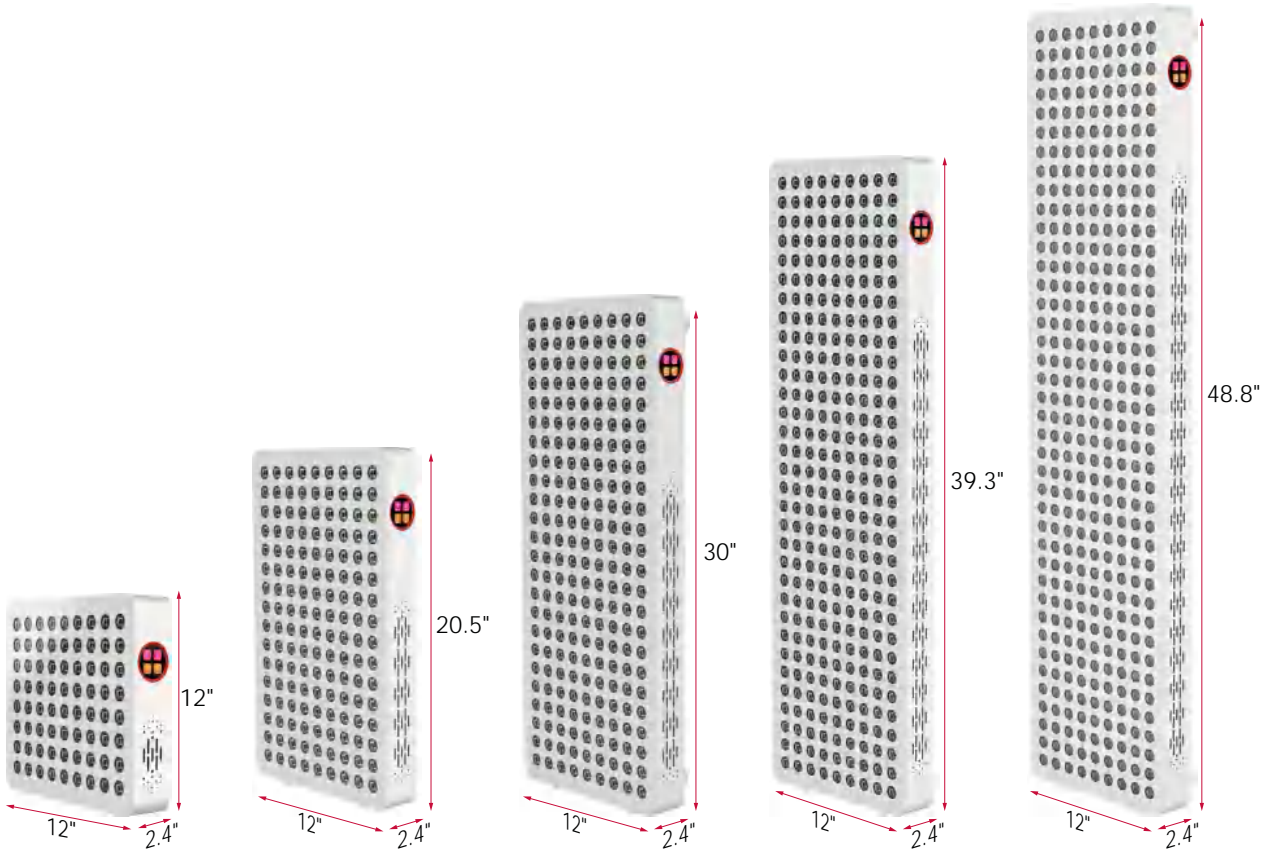



## MOUNTING KITS

### 1. Door Mount

(Standard for RP360Z/RP720Z/RP1080Z/RP1440Z/RP1800Z)

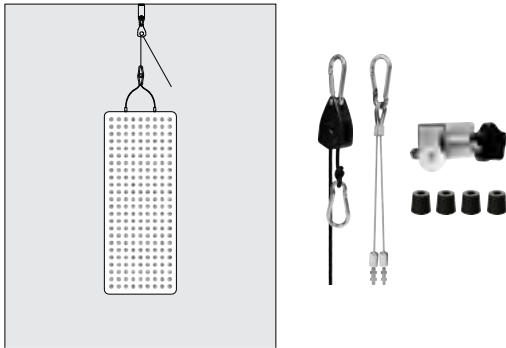

### 2. Wall Mount

(Optional for RP2800Z/RP3600Z/RP4320Z)

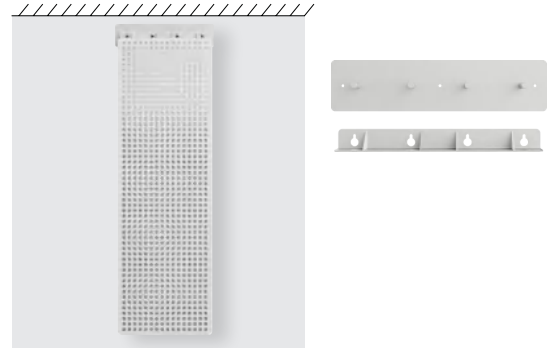

## STAND

### 1. Table top stand (only for RP360Z)

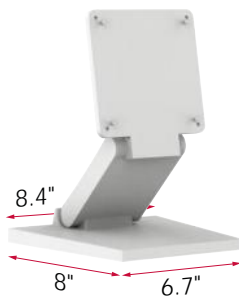

### 2. Folding floor stand 2 wheels

(for RP720Z/RP1080Z/RP1440Z/RP1800Z)

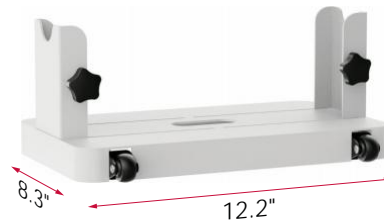

## OPTIONAL STAND

### 1. Folding floor stand 4 wheels

(for RP720Z/RP1080Z/RP1440Z/RP1800Z)

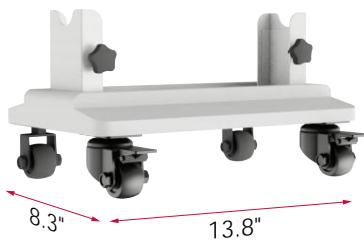

### 2. Floor stand 4 wheels

(for RP2800Z/RP3600Z/RP4320Z)

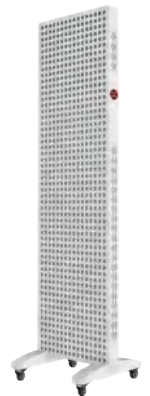

### 3. Electric Horizontal & Vertical Stand

Use wired or wireless remote controller to adjust the height of the stand.



Remote controller



Wired controller

#### 4. Manual Horizontal & Vertical Stand(only for RP720Z/RP1080Z/RP1440Z/RP1800Z)



#### 5. Combined Stand(only for RP1080Z/RP4320Z)

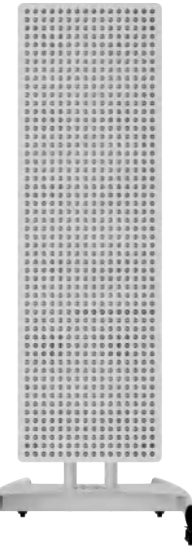
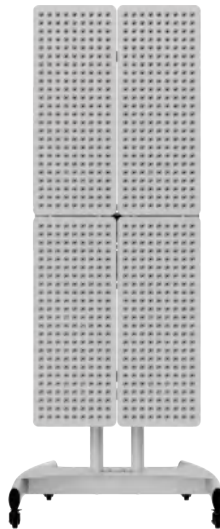

## PACKAGE CONTENTS

- BioMol RP series panel device x 1
- BioMol remote controller x 1
- Readable glasses x 1
- Power cable x 1
- Stand x 1
- BioMol user manual x 1

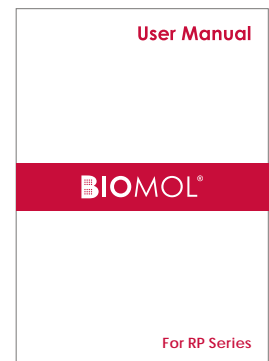
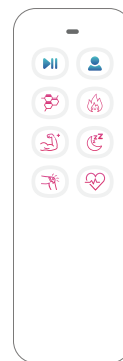

**BIOMOL®**

## RL SERIES

# LED RED LIGHT THERAPY

No need any appointment to beauty salons or health treatment clubs, the path to beauty and wellness can be traversed within the confines of your own home, at your convenience.

BioMol's advanced RL series offers both half-body and full-body therapy, presenting a comprehensive approach to health and vitality. Our cutting-edge dual-mode touch keys and remote controller enable you to effortlessly operate the device from a distance, ensuring simplicity and control at your fingertips. Embrace this transformative experience and relish the remarkable benefits it delivers!



2 Channels + 2 Spectra



All 3535 5w LEDs



Touch Key



Remote Controller

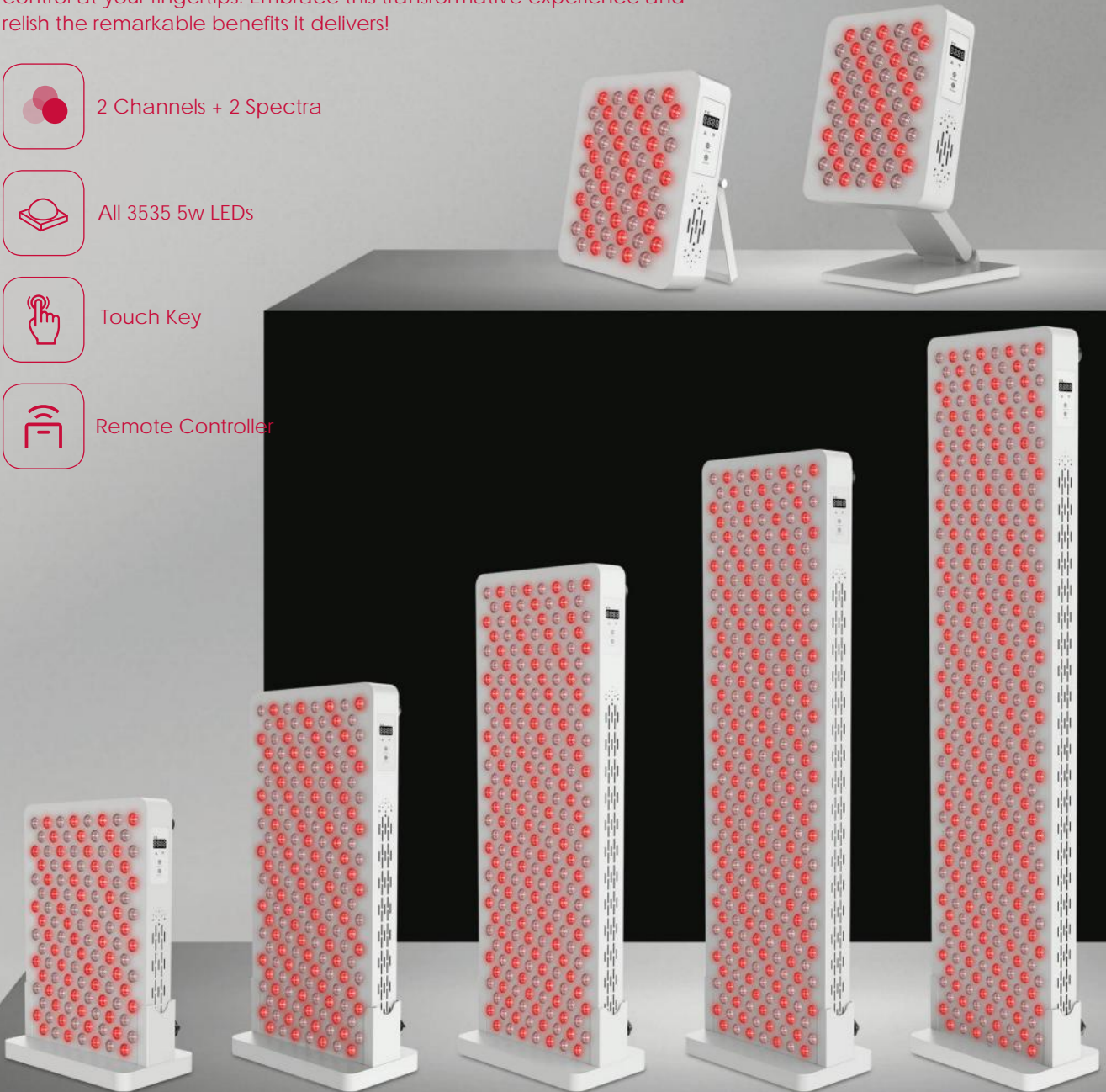

# BioMol RL Series



⚠ Please wear glasses or close eyes when enjoying therapy.

# 2 CHANNELS+2 SPECTRA

Meet different customer needs

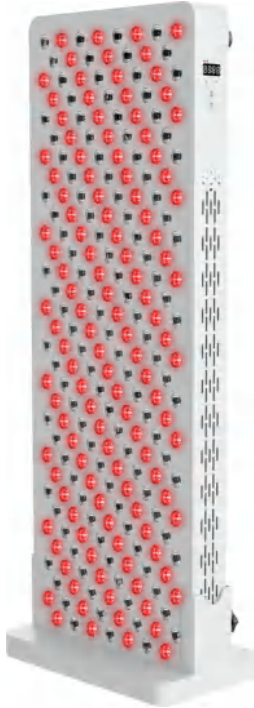

Channel 1# RED (660nm)

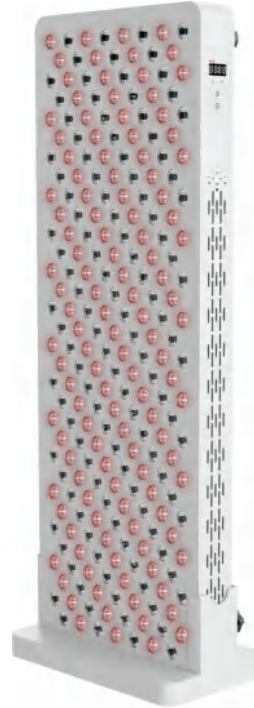

Channel 2# NIR (850nm)

## TOUCH KEYS

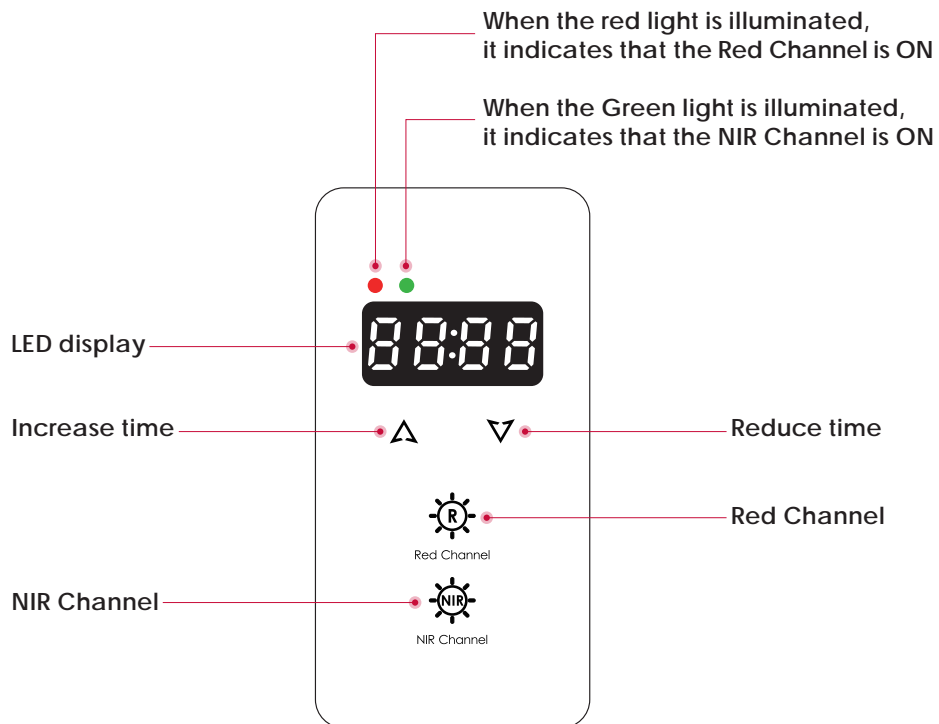

# BIOMOL RL SERIES

## RL300A



<b>LEDs:</b>	60x5W 3535 LED
<b>Wavelength:</b>	Channel 1# Red (660nm) Channel 2# NIR (850nm)
<b>Beam angle:</b>	30 degrees
<b>Control way:</b>	Touch key & Remote controller
<b>Voltage:</b>	AC85-240V
<b>Irradiance:</b>	>520mW/cm <sup>2</sup>
<b>Flicker:</b>	Flicker free
<b>EMF:</b>	0.0μt
<b>Use way:</b>	Support bracket
<b>Lifespan:</b>	>100,000 Hours
<b>Warranty:</b>	3 Years
<b>Material:</b>	Iron
<b>Product size:</b>	260x215x60mm/10.2"x8.5"x2.4"
<b>Product weight:</b>	3KG/6.6LB
<b>Gross weight:</b>	4.5KG/9.9LB

## RL300B



<b>LEDs:</b>	60x5W 3535 LED
<b>Wavelength:</b>	Channel 1# Red (660nm) Channel 2# NIR (850nm)
<b>Beam angle:</b>	30 degrees
<b>Control way:</b>	Touch key & Remote controller
<b>Voltage:</b>	AC85-240V
<b>Irradiance:</b>	>520mW/cm <sup>2</sup>
<b>Flicker:</b>	Flicker free
<b>EMF:</b>	0.0μt
<b>Use way:</b>	Table stand
<b>Lifespan:</b>	>100,000 Hours
<b>Warranty:</b>	3 Years
<b>Material:</b>	Iron
<b>Product size:</b>	260x215x60mm/10.2"x8.5"x2.4"
<b>Product weight:</b>	3KG/6.6LB
<b>Gross weight:</b>	4.5KG/9.9LB

# BIOMOL RL SERIES

## RL600



LEDs:	120x5W 3535 LED
Wavelength:	Channel 1# Red (660nm) Channel 2# NIR (850nm)
Beam angle:	30 degrees
Control way:	Touch key & Remote controller
Voltage:	AC85-240V
Irradiance:	>520mW/cm <sup>2</sup>
Flicker:	Flicker free
EMF:	0.0μt
Use way:	Multiple stands
Lifespan:	>100,000 Hours
Warranty:	3 Years
Material:	Iron
Product size:	440x300x60mm/17.3"x12"x2.4"
Product weight:	4.5KG/9.9LB
Gross weight:	6KG/13.2LB

## RL900

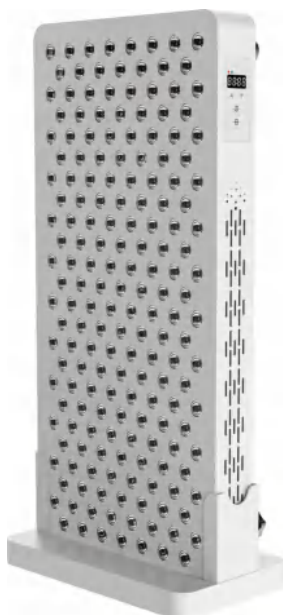

LEDs:	180x5W 3535 LED
Wavelength:	Channel 1# Red (660nm) Channel 2# NIR (850nm)
Beam angle:	30 degrees
Control way:	Touch key & Remote controller
Voltage:	AC85-240V
Irradiance:	>530mW/cm <sup>2</sup>
Flicker:	Flicker free
EMF:	0.0μt
Use way:	Multiple stands
Lifespan:	>100,000 Hours
Warranty:	3 Years
Material:	Iron
Product size:	640x300x60mm/25"x12"x2.4"
Product weight:	7KG/15.4LB
Gross weight:	9KG/19.8LB

# BIOMOL RL SERIES

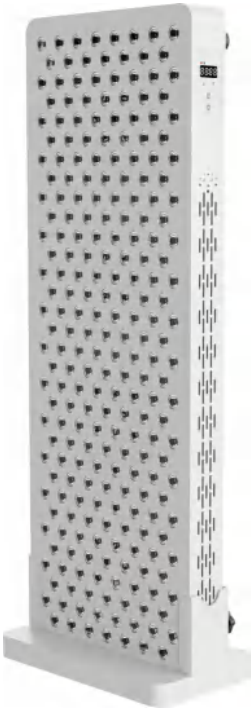

## RL1200

LEDs:	240x5W 3535 LED
Wavelength:	Channel 1# Red (660nm) Channel 2# NIR (850nm)
Beam angle:	30 degrees
Control way:	Touch key & Remote controller
Voltage:	AC85-240V
Irradiance:	>530mW/cm <sup>2</sup>
Flicker:	Flicker free
EMF:	0.0μt
Use way:	Multiple stands
Lifespan:	>100,000 Hours
Warranty:	3 Years
Material:	Iron
Product size:	840x300x60mm/33"x12"x2.4"
Product weight:	9KG/19.8LB
Gross weight:	11.5KG/25.4LB

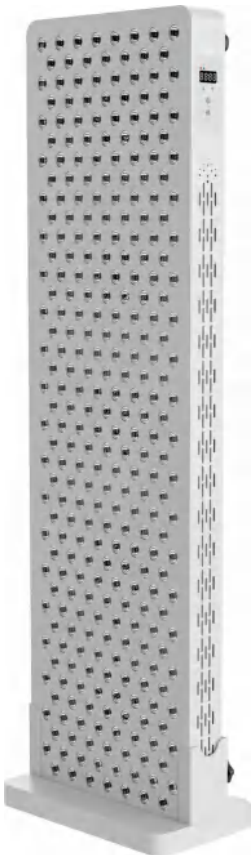

## RL1500

LEDs:	300x5W 3535 LED
Wavelength:	Channel 1# Red (660nm) Channel 2# NIR (850nm)
Beam angle:	30 degrees
Control way:	Touch key & Remote controller
Voltage:	AC85-240V
Irradiance:	>580mW/cm <sup>2</sup>
Flicker:	Flicker free
EMF:	0.0μt
Use way:	Multiple stands
Lifespan:	>100,000 Hours
Warranty:	3 Years
Material:	Iron
Product size:	1040x300x60mm/41"x12"x2.4"
Product weight:	12KG/26.5LB
Gross weight:	14.5KG/32LB



# BIOMOL RL SERIES

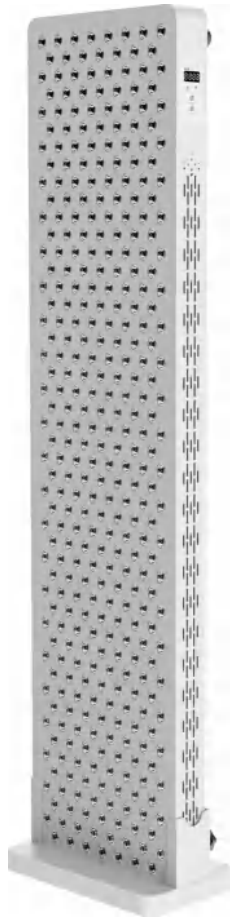

## RL1800

<b>LEDs:</b>	360x5W 3535 LED
<b>Wavelength:</b>	Channel 1# Red (660nm) Channel 2# NIR (850nm)
<b>Beam angle:</b>	30 degrees
<b>Control way:</b>	Touch key & Remote controller
<b>Voltage:</b>	AC85-240V
<b>Irradiance:</b>	>580mW/cm <sup>2</sup>
<b>Flicker:</b>	Flicker free
<b>EMF:</b>	0.0μt
<b>Use way:</b>	Multiple stands
<b>Lifespan:</b>	>100,000 Hours
<b>Warranty:</b>	3 Years
<b>Material:</b>	Iron
<b>Product size:</b>	1240x300x60mm/48.8"x12"x2.4"
<b>Product weight:</b>	15KG/33.1LB
<b>Gross weight:</b>	17.5KG/38.6LB

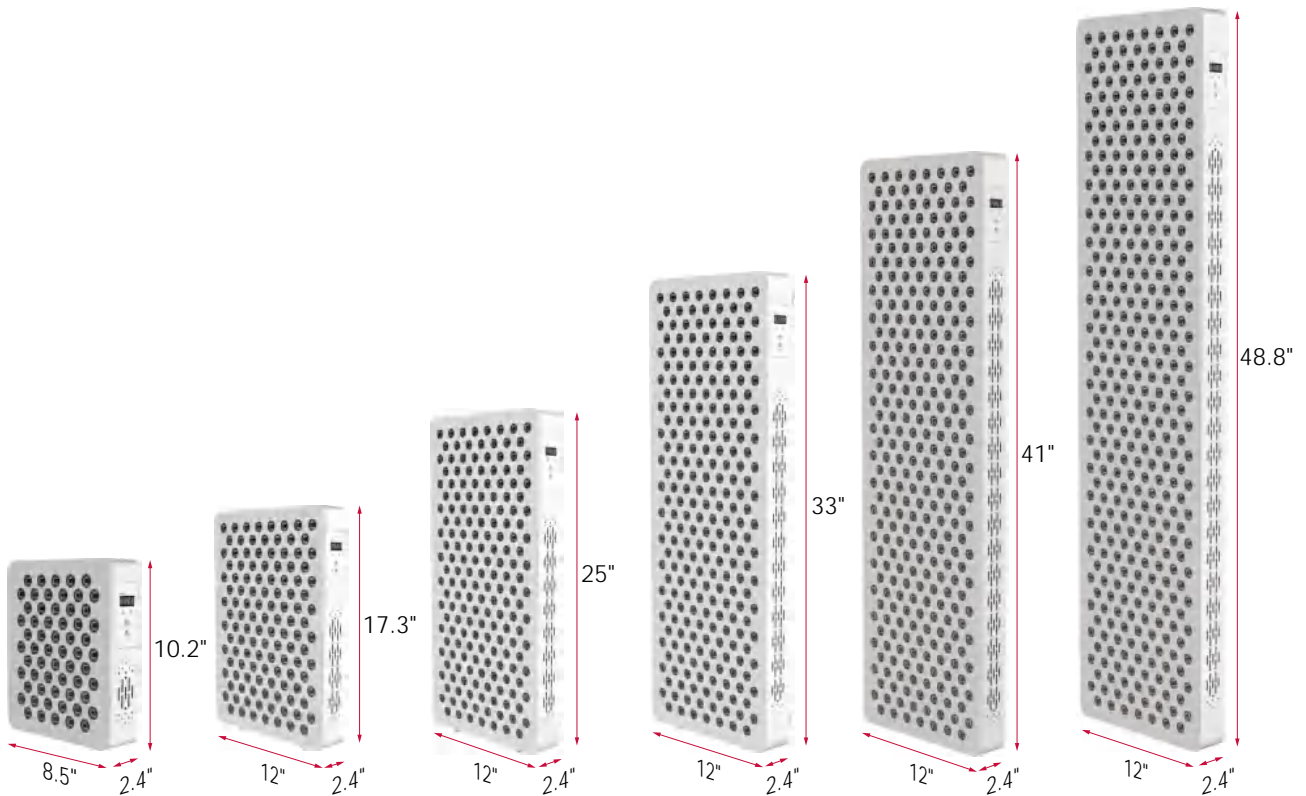

# STAND

## 1. Table top stand (only for RL300)

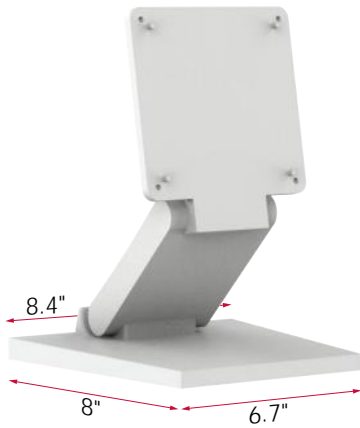

## 2. Folding floor stand (for RL600/RL900/RL1200/RL1500/RL1800)

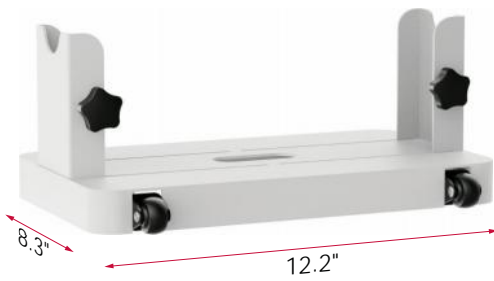

Folding floor stand 2 wheels  
(Standard)

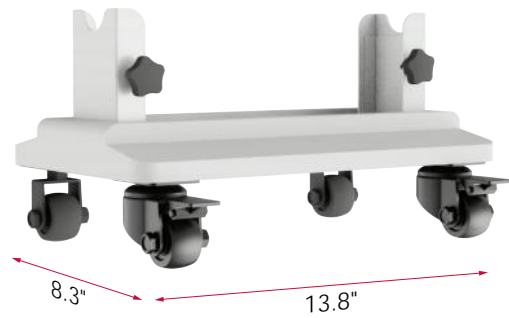

Folding floor stand 4 wheels  
(Optional)

# PACKAGE CONTENTS

- BioMol RL series panel device x 1
- BioMol remote controller x 1
- Readable glasses x 1
- Power cable x 1
- Stand x 1
- BioMol user manual x 1

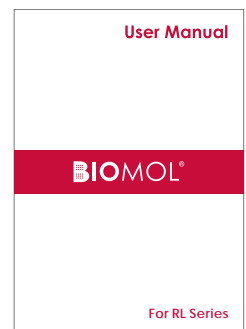

**BIOMOL**<sup>®</sup>

# WEARING SERIES LED RED LIGHT THERAPY

The wearing Series is for more considerate care, easier to use for beauty treatments.

Nanometer technology face mask comfortable lying on the sofa to enjoy red light therapy, whitening and brightening, skin tightening.

Improve local blood circulation, promote metabolism, LED therapy belt lose weight and shape up.

Red light therapy Cap for hair growth. Inject healthy energy into the scalp to hair root to wake up the hair follicles and promote hair growth. Say goodbye to Hair loss

Just enjoy it!

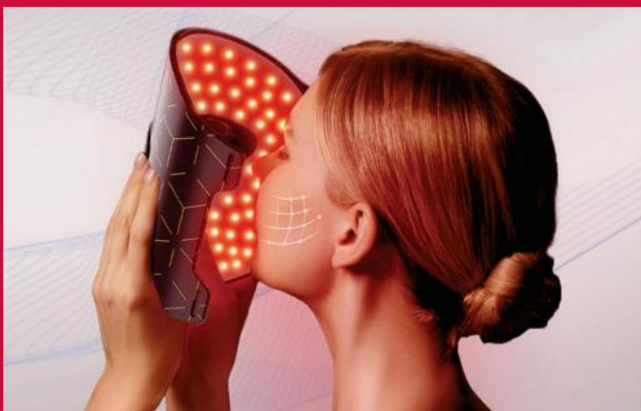
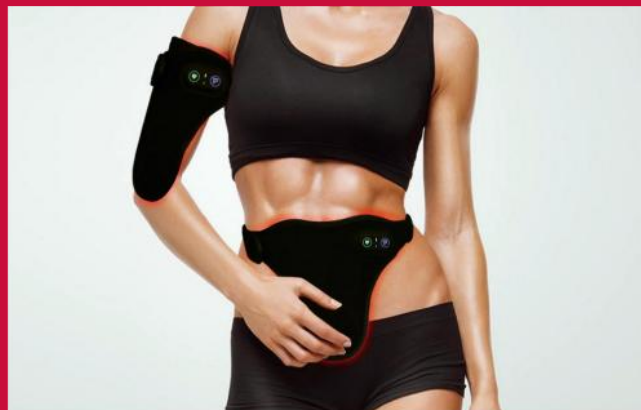

# BIOMOL RED LIGHT THERAPY HAIRCARE CAP



## BM-CAP-A



LEDs:	125x0.5W 5050 LED
Wavelength:	1x 660nm / 2 x 850nm
Beam angle:	90 degrees
Control way:	Controller cable
Voltage:	AC100-240V
Flicker:	Flicker free
Power consumption:	Dimming (P1-20%-30W, P2-40%-60W, P3-60%-90W, P4-80%-110W, P5-100%-140W)
EMF:	0.0μt
Time:	5/10/15/20/25/30 minutes
Lifespan:	>50,000 Hours
Warranty:	1 Year
Material:	Fabric
Product size:	280 x 190 x 135mm/11" x 7.5" x 5.3"
Product weight:	0.2kg/0.44LB
Gross weight:	0.5kg/1.1LB
Packing:	284 x 194 x 139mm/ 11.2" x 7.6" x 5.5"

## BM-CAP-B



LEDs:	124x0.5W 5050 LED
Wavelength:	1x 660nm / 2 x 850nm
Beam angle:	90 degrees
Control way:	Silicone controller
Voltage:	AC100-240V
Battery capacity:	2000mAh
Flicker:	Flicker free
Power consumption:	20W
EMF:	0.0μt
Time:	30 minutes
Lifespan:	>50,000 Hours
Warranty:	1 Year
Material:	Fabric
Product size:	280 x 190 x 135mm/11" x 7.5" x 5.3"
Product weight:	0.28kg/0.62LB
Gross weight:	0.4kg/0.88LB
Packing:	284 x 194 x 139mm/ 11.2" x 7.6" x 5.5"

# HOW IT WORKS FOR HAIR REGROWTH?









Low-level laser therapy also referred to as red light therapy and cold laser therapy-irradiates photons into scalp tissues. These photons are absorbed by weak cells to encourage hair growth.

It's widely accepted that the procedure is safe, tolerable, and less invasive than hair transplant surgery.

**RED 660nm**  
**Superficial**  
 For hair roots close to the scalp.

**NIR 850nm**  
**Oil control**  
 Oil control on the surface of the scalp.

## CONTROLLER: 3 BRIGHTNESS/2 FREQUENCIES

 <p><b>Frist press "☀️"</b>              Turn on,              It is level-1 brightness</p>	 <p><b>Frist press "🔄"</b>              breathe mode,              LEDs' brightness gradient</p>
 <p><b>Second press "☀️"</b>              It is level-2 brightness</p>	 <p><b>Second press "🔄"</b>              10Hz pulse mode</p>
 <p><b>Third press "☀️"</b>              It is level-3 brightness</p>	 <p><b>Third press "🔄"</b>              40Hz pulse mode</p>
 <p><b>Long press "☀️"</b>              turn off the cap</p>	<p><b>Charged</b>              "⚡" is red and flashing  <b>Full</b>              "⚡" is green, always on</p>

## CONTROLLER: 5 BRIGHTNESS/2 FREQUENCIES

**Brightness setting: 5 levels**  
 (L0/L1/L2/L3/L4)

**Time setting: 6 time periods**  
 (05/10/15/20/25/30min)



**Mode setting:**  
 (660nm, 850nm, ALL)

**Frist press:** Turn On, ALL Mode  
**Second press:** 10Hz Pulse Mode  
**Third press:** 40Hz Pulse Mode  
**Fourth press:** Turn Off

# BIOMOL RED LIGHT THERAPY MASK

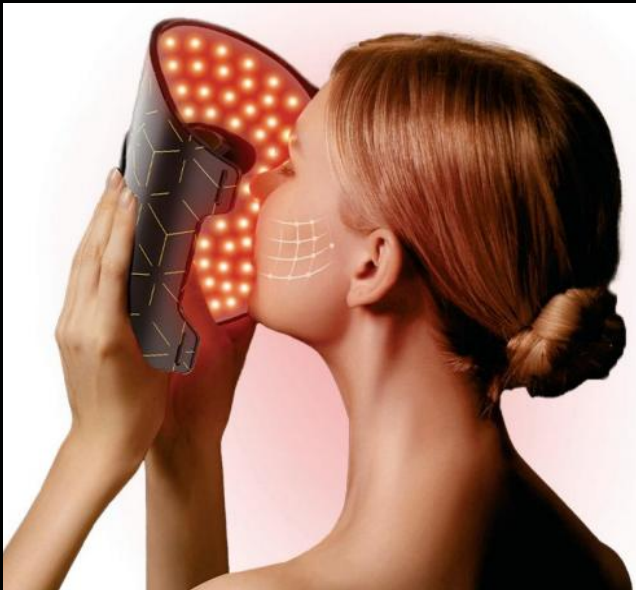

## BM-MASK



LEDs:	Face 92x0.2W LED / Neck 78x0.2W LED
Wavelength:	RED 635nm
	NIR 850nm
	BLUE 415nm
	ORANGE 605nm
Beam angle:	90 degrees
Control way:	Controller
Voltage:	AC100-240V
Flicker:	Flicker free
EMF:	0.0μt
Lifespan:	>50,000 Hours
Warranty:	1 year
Material:	Silicone
Product size:	Face 315 x 219 x 5mm/12.4" x 8.6" x 0.2"
	Neck 325 x 247 x 5mm/12.8" x 9.7" x 0.2"
Product weight:	Face/Neck:0.2kg/0.5LB
Gross weight:	1.2kg/2.65LB
Packing:	340 x 265 x 50mm/13.4" x 10.4" x 2"

## CONTROLLER





# BIOMOL RED LIGHT THERAPY BELT





## BM-Belt

Leds:	105x0.2W LED(63pcs 660nm red + 42pcs 850nm NIR)
Wavelength:	660nm / 850nm
Beam angle:	90 degrees
Control way:	Controller
Voltage:	AC100-240V
Power consumption:	Max 16W
Flicker:	Flicker free
EMF:	0.0μt
Time:	5/10/15/20/25/30mins
Lifespan:	>50,000 Hours
Warranty:	1 year
Material:	Fabric
Product size:	1300 x 180mm x 6mm/51" x 7" x 0.2"
Product weight:	0.67kg/1.5LB
Gross weight:	1.2kg/2.65LB
Packing:	280 x 240 x 120mm/11" x 9.5" x 4.7"

## CONTROLLER:5 BRIGHTNESS/2 FREQUENCIES



# BIOMOL RED LIGHT THERAPY PAD



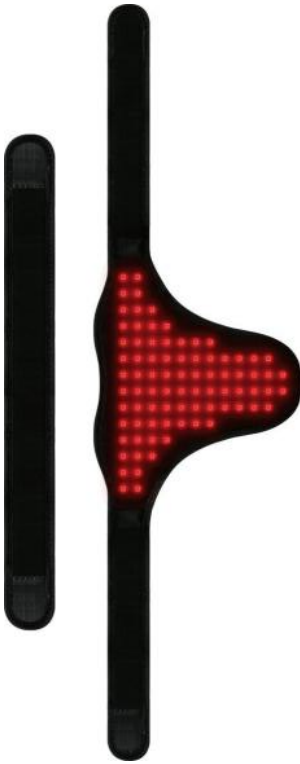

## BM-PAD

LEDs:	82x0.5W 5050LED
Wavelength:	1x 660nm / 2 x 850nm
Beam angle:	90 degrees
Control way:	Button controller
Voltage:	AC100-240V
Battery capacity:	2000mAh
Charging way:	USB recharge
Flicker:	Flicker free
EMF:	0.0μt
Time:	30 minutes
Lifeapan:	>50,000 Hours
Warranty:	1 year
Material:	Fabric
Product size:	800 x 210 x 18mm/31.5" x 8.3" x 0.7"
Product weight:	0.16kg/0.35LB
Gross weight:	0.44kg/0.9LB
Packing:	210 x 150 x 70mm/8.3" x5.9" x 2.8"

## CONTROLLER: 3 BRIGHTNESS/2 FREQUENCIES



**Frist press " 🔥 "**  
Turn on,  
It is level-1 brightness



**Frist press " 📊 "**  
breathe mode,  
LEDs' brightness gradient



**Second press " 🔥 "**  
It is level-2 brightness



**Second press " 📊 "**  
10Hz pulse mode



**Third press " 🔥 "**  
It is level-3 brightness



**Third press " 📊 "**  
40Hz pulse mode



**Long press " 🔥 "**  
turn off the cap



**Charged**  
" 🔥 " is red and flashing  
**Full**  
" 🔋 " is green, always on

# BIOMOL RED LIGHT THERAPY MAT

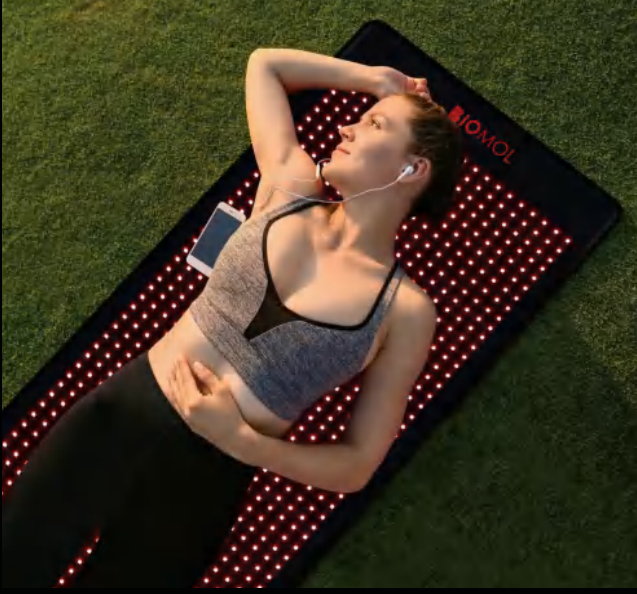

# BM-Mat

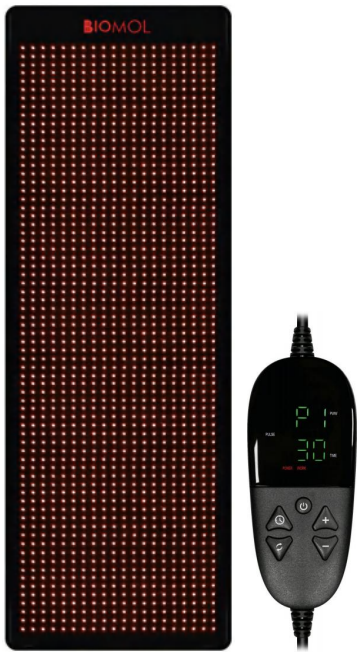

Leds:	1400x0.5W 5050 LED
Wavelength:	660nm / 850nm
Beam angle:	90 degrees
Control way:	Controller
Voltage:	AC100-240V
Power consumption:	Dimming (P1-20%-30W, P2-40%-60W, P3-60%-90W, P4-80%-110W,P5-100%-140W)
Flicker:	Flicker free
EMF:	0.0μt
Time:	10/20/30/40/50/60/70/80/90 Minutes
Lifespan:	>50,000 Hours
Warranty:	1 Year
Material:	Fabric
Product size:	1800 x 630mm x 6mm/70.9" x 24.8" x 0.24"
Product weight:	1.7kg/3.7LB
Gross weight:	4.5kg/9.9LB
Packing:	680 x 220 x 220mm/26.8" x 8.7" x 8.7"

## CONTROLLER: 5 BRIGHTNESS/2 FREQUENCIES



# Irradiance testing instrument

Model: HP350FR

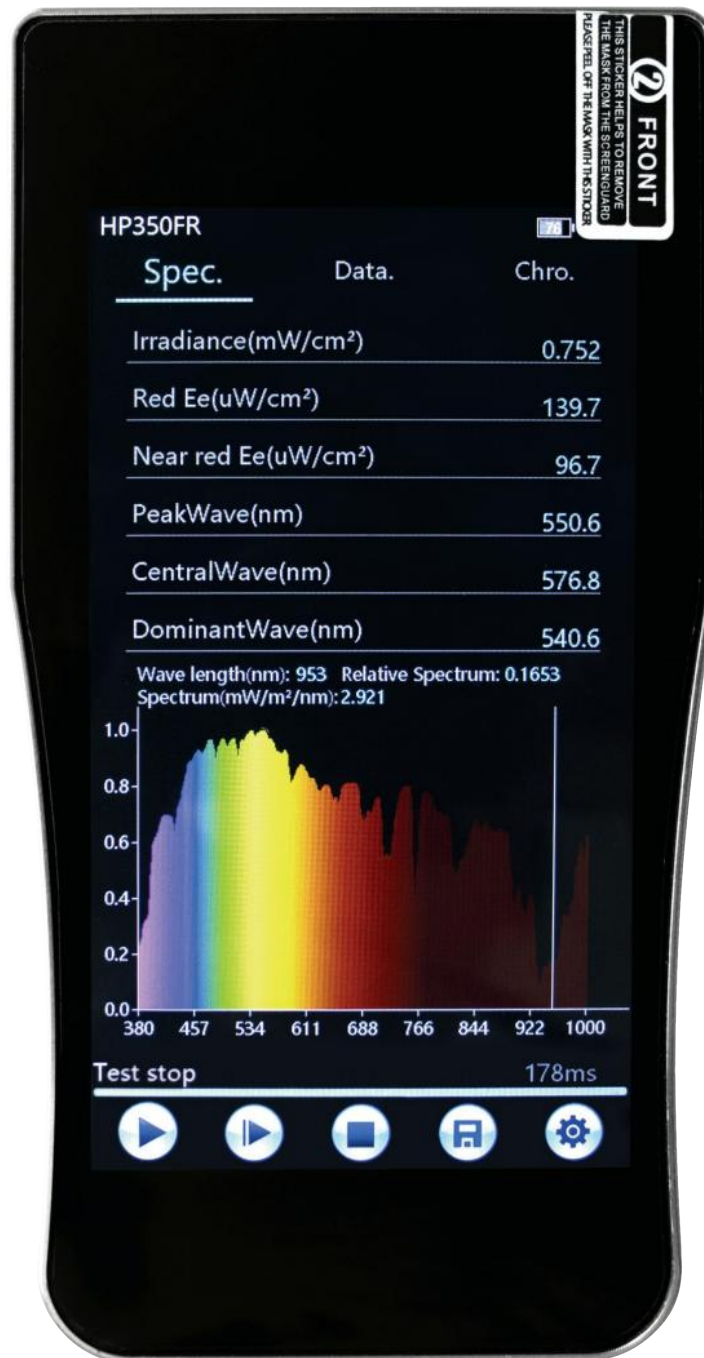

The most accurate irradiance testing instrument available on the market

**BIOMOL**<sup>®</sup>

