

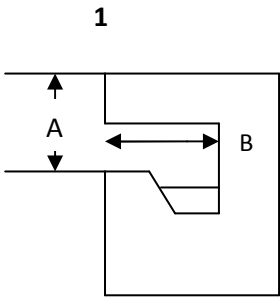

DECK CONFIGURATOR ROTATIONAL SERIES LIFTS

R-375

PLEASE CHOOSE WHICH APPLICATION YOUR POOL GUTTER BEST REPRESENTS



Fully Recessed Gutter

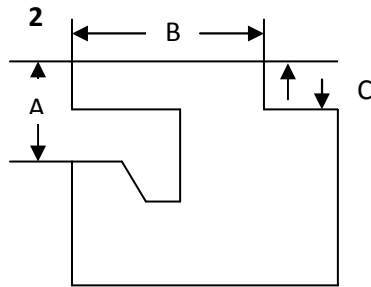

Fully Recessed Gutter
W/ parapet

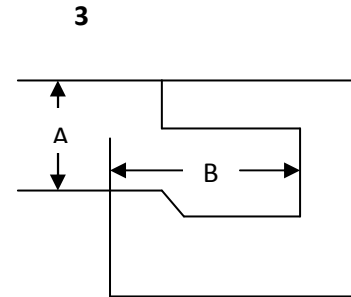

Partially Recessed
Gutter

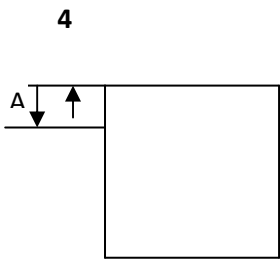

Gutter less Deck

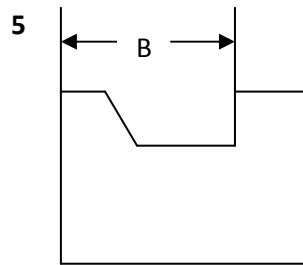

Flush Gutter & Deck
With or without bull
nose

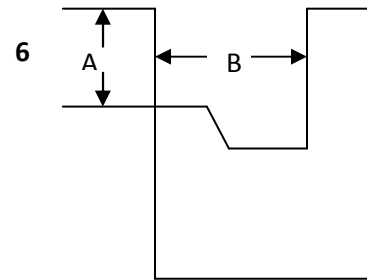

Rollout Gutter

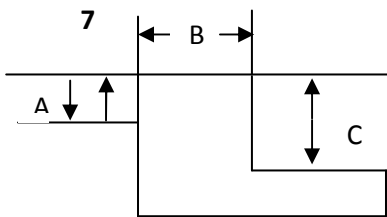

Above Ground Pool

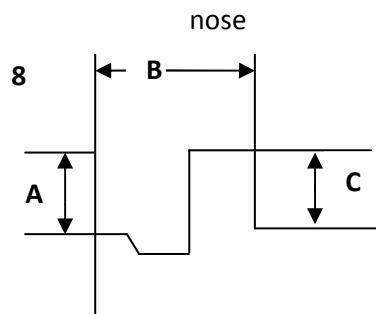

Gutter System with Curb

LEGEND MIN/MAX	
A=	(Draft) pool deck to water line 0 – 12"
B=	Width of Gutter 0 – 28"
C=	Height of Curb 0 – 10"

**NOTE: If your doesn't fall within these measurements,
Please contact your dealer for assistance.**