

Charging Cart Instructions

03/29/17

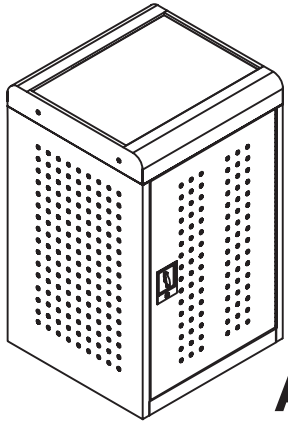

A x1

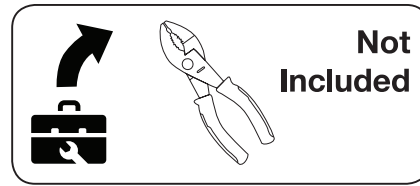
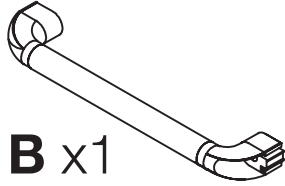

B x1

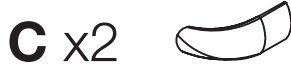

C x2



D x1

E x2

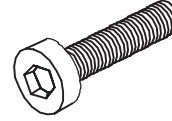

G x2



J x1



F x1



H x2



K x1



L x2



1

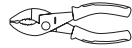
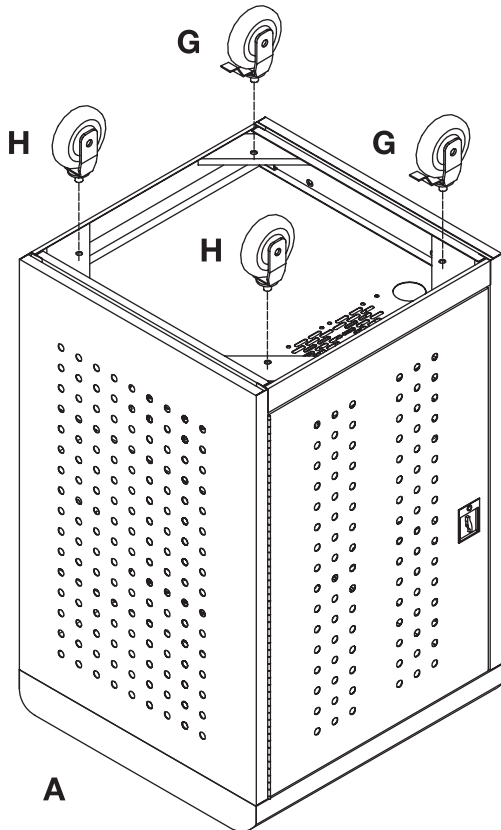

2



Heavy Lifting:
Assistance
Required

