

# 2235D Electric Beauty Bed

# User Manual

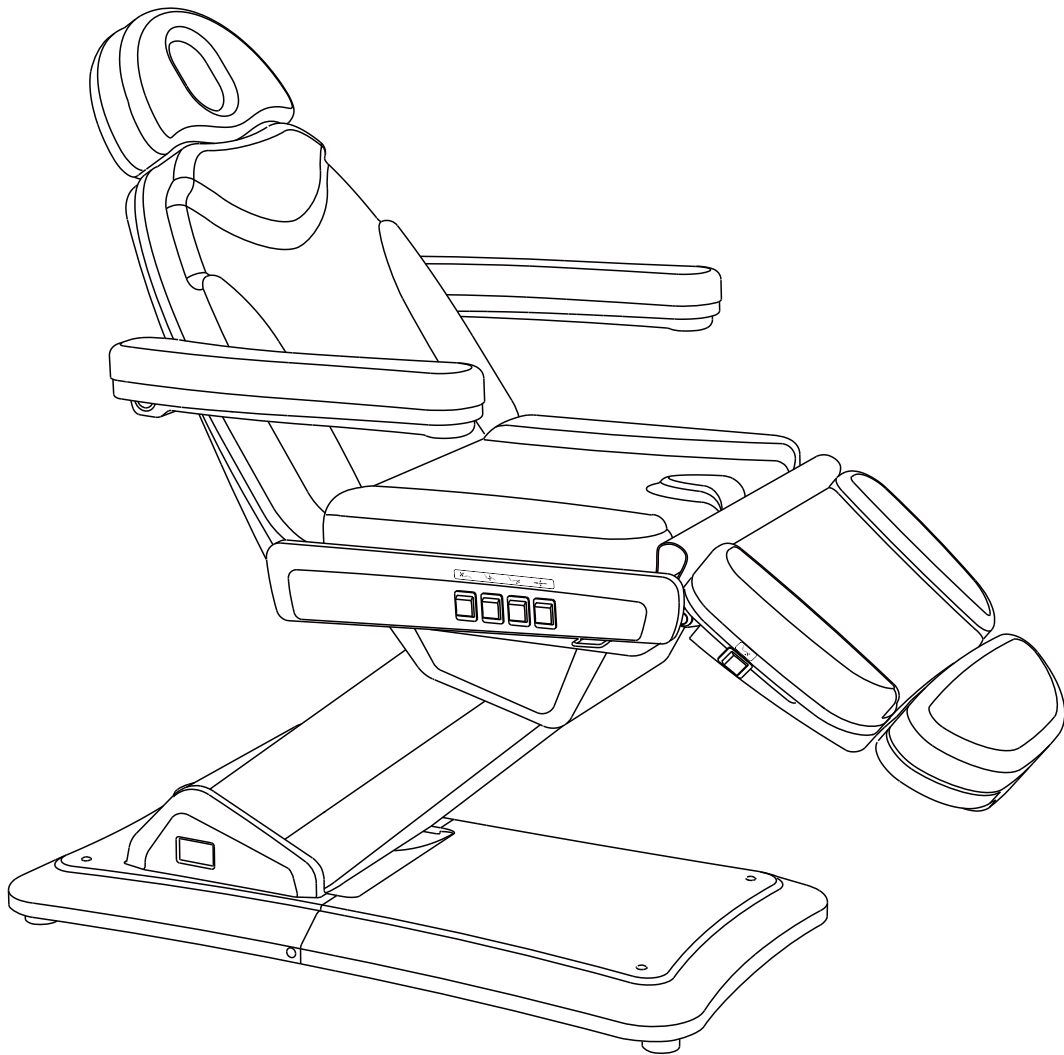

Welcome to use our 2235D Beauty bed,  
Before use the bed, please read the user manual carefully, thanks. A0

## 1. About This Manual

This manual shall only be used for the reference of operation of this particular model. If the manual is used for other purposes, SilverFox will not undertake any according consequences and responsibility. All information of this manual shall be protected by copyright and shall not be copied, copied and translated in any part of this specification without the written consent of our company SILVERFOX.

## 2. Warning

Power supply must be cut off when changing electrical components or maintaining and cleaning machines.

The plug must be plugged into an outlet that is properly installed and grounded, to prevent the risk of fire and electric shock.

Do not stand on this equipment.

Do not allow children to play with and place the equipment in a place where children can avoid touching; Please adjust the backrest back to the highest position when you leave.

Please do not place the equipment in damp places such as bathroom to avoid electric shock or other failure; The remote control should also avoid contact with water.

Please do not place the equipment in places where painting/coating or oxygen providing during operation.

Unless being monitored or instructed by personnel who can be responsible for their personal safety, the people who have physical obstacles, tactile disorders, mental disorders, lacking of experience, common sense or children, are not allow to use the equipment.

Please contact distributor, service center or related personal with appropriate skill and experience for repairing if the plug is damaged, in case of any dangerous.

Please make sure there is no accessible thing within the stroke during any operation of the beds.

Maintenance should be processed by trained professionals.

## 3. Precautions

Read this manual carefully before installation, operation and adjustment. And please keep it well.

This Electric beauty bed is equipped with a three-wire power cord. The power cord must be plugged into an three-hole outlet which is properly installed and grounded. This is not only to prevent the risk of electric shock, but also ensure bed work properly.

When adjusting the backrest, seat cushion, footrest or lifting of the whole bed by manual controller or foot control switch, please keep your hands, feet and head away from the position 1.2.3.4.5.6.7 showed on below photo to avoid getting jammed.

While controlling the lifting of the whole bed, the button must be pressed continuously until the bed be in a suitable position.

Please pay attention that the input frequency should be  $M_s \times 6 \text{min/h}$  when operating the motor.

Maintenance should be processed by trained professionals.

After each treatment, please use neutral reagent to clear the dust, stains on leather or on plastic cover.

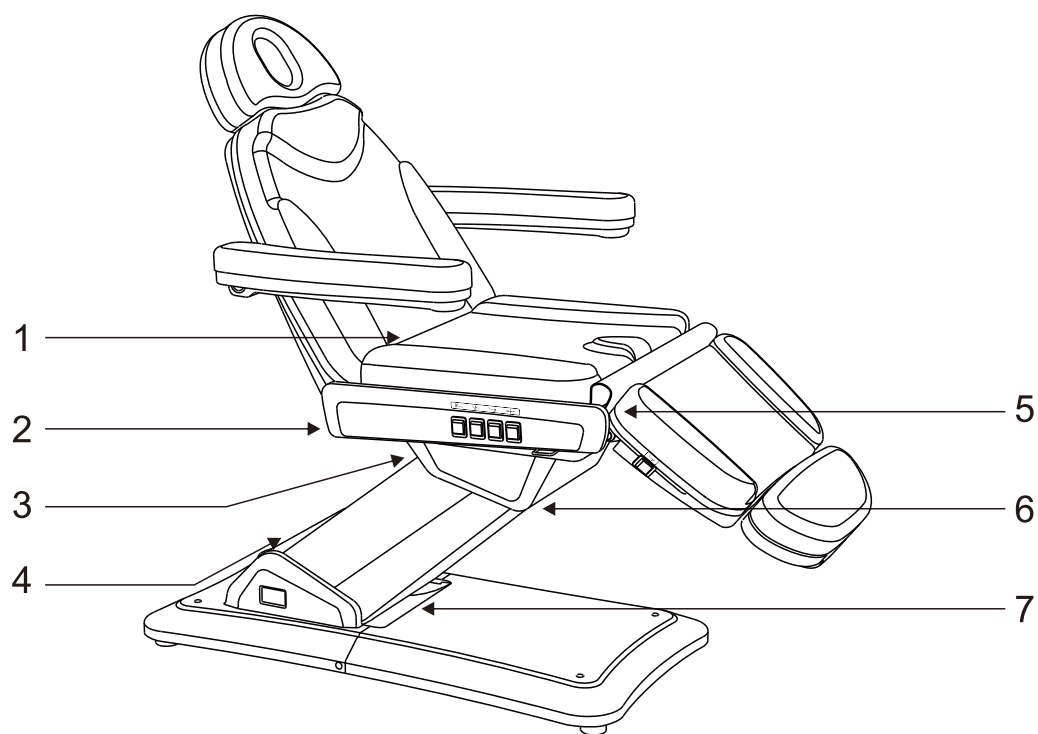

#### 4. Structure of electric beauty bed

This beauty bed consists of controller box, motor, hardware, plastic parts and leather. Among them, the controller box is controlling the operation of four motors and the hand controller.

This beauty bed includes angel adjustment of the backrest, angel adjustment of the seat cushion, angel adjustment of the footrest and lifting adjustment of the whole bed which is an overall and integral structure. (Details as shown below)

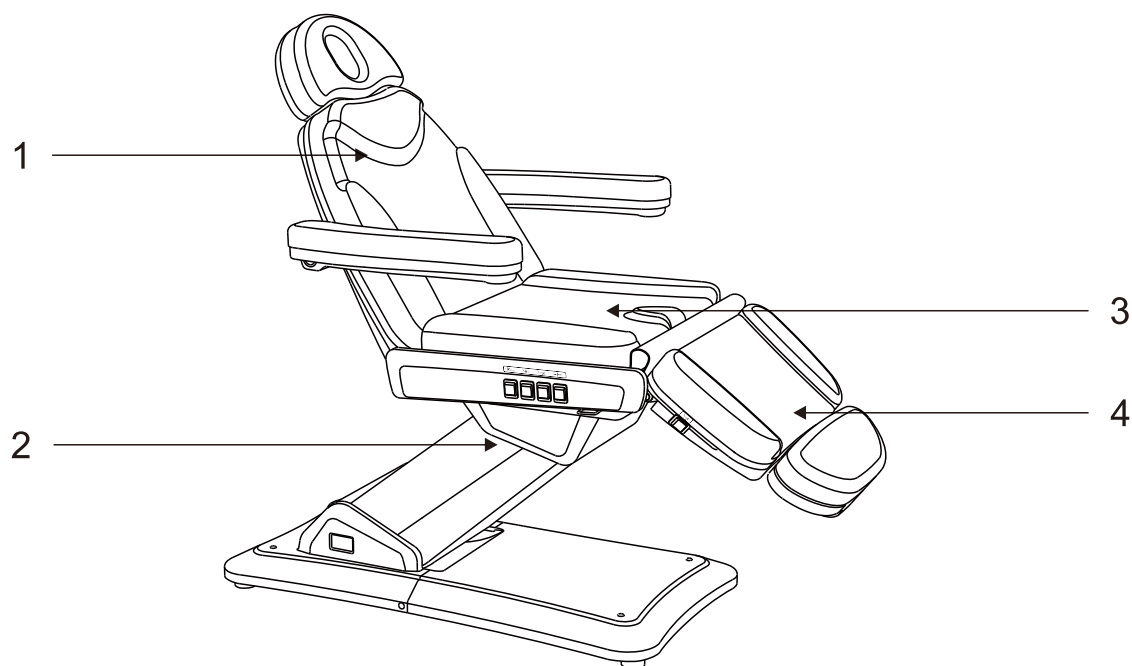

1. Angel adjustment of the backrest

2. Lifting adjustment of the whole bed

3. Angel adjustment of the seat cushion

4. Angel adjustment of the footrest

## 5. Serviceable range

This electric beauty bed is suitable for beauty and massage treatment.

## 6. Installation

1. Put the bed to a proper location, according to the overall layout, the daylighting or artificial lightings and operation condition of the salon's or the home. And keep it in the clean, dry and cool operating environment.

2. Open the Packing Carton to Check Open the packing carton, check if the bed is intact and whether the accessories or spares are complete. Please contact distributor or us if there's any problem.

### 3. Installation

Place the bed to the proper position. Please note that it is unnecessary to install extra screw on the floor to fasten the bed, because the original design has take the stability performance into consideration. But please ensure the bed is placed on a firm and flat ground, so as to prevent any accident. If the bed rotates or slant due to rough ground, you could adjust the four pieces of plastic feet (M10×30) and nuts (M10) by hexagon open-end wrench, which are fasten on the bottom panel, so as to ensure the bed is stable.

### 4. Power Input

Voltage and frequency input shall be AC 100-130, 50/60Hz or 220-240V, 50/60Hz. Plug the bed on the power supply properly. (Details as shown below)

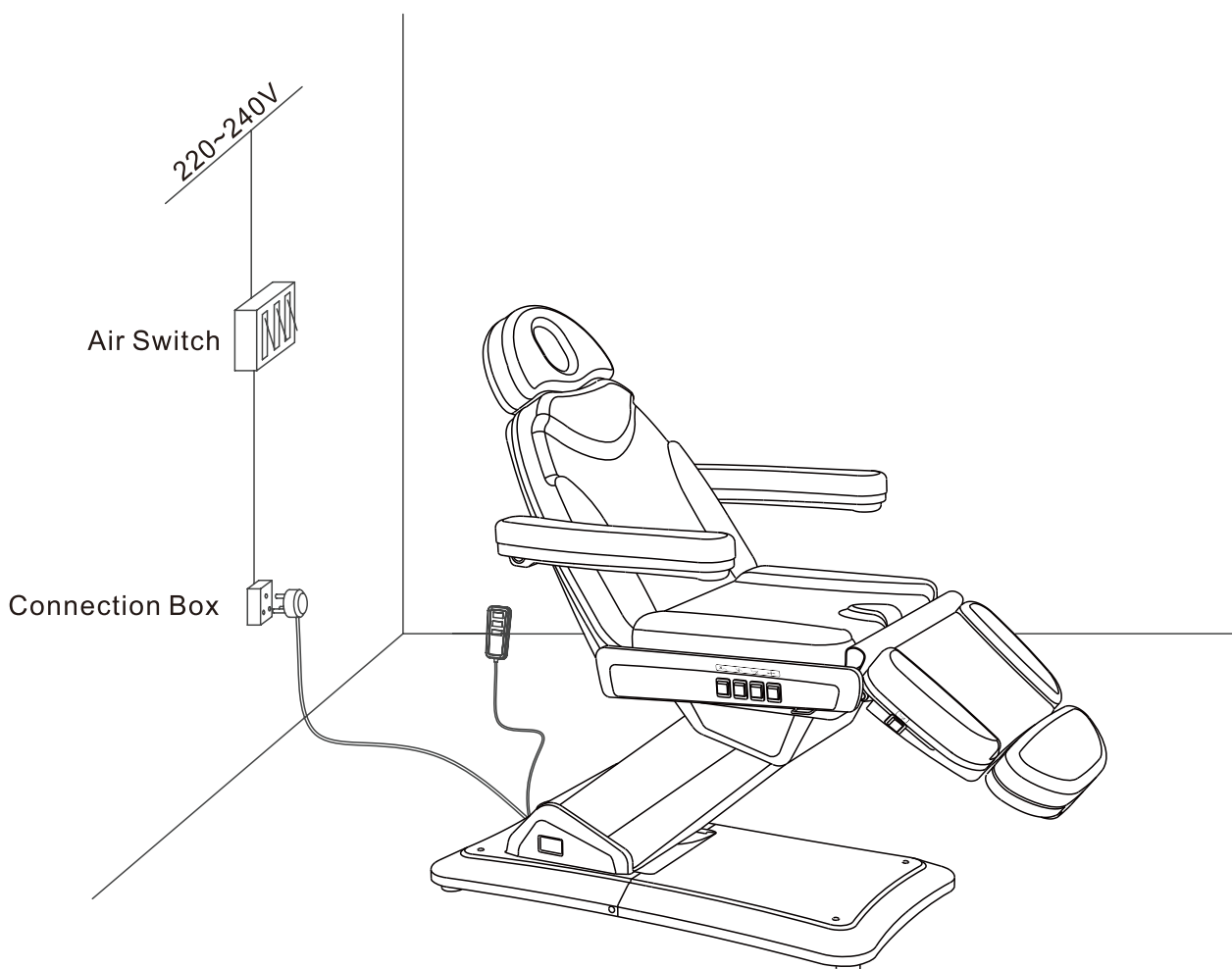

## 7. Operation Instruction

### 1. Standard configuration (Rocket Switch)

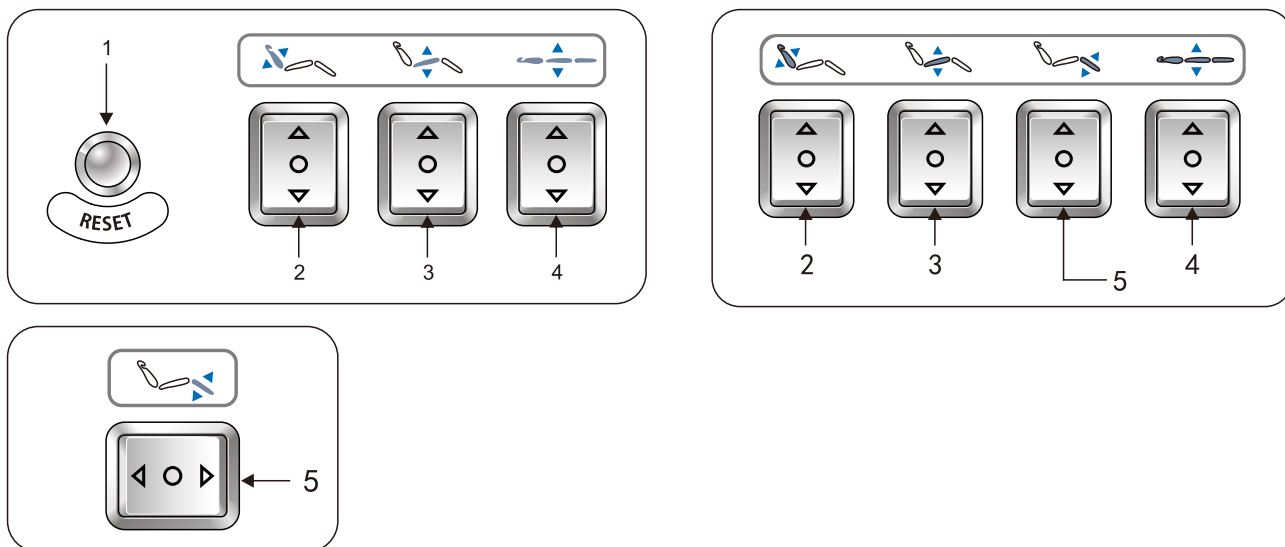

	Description	Operation
1	One-key reset button	Press the button, the backrest angle will automatically move to the maximum, the cushion angle will automatically move to the maximum, leg pad angle will automatically reduce to the minimum, the height of the bed will automatically reach the lowest position.
2	Backrest motor button	Backrest goes up (goes down) smoothly by pressing the button.
3	Cushion angle motor button	Angle of cushion increases (decreases) smoothly by pressing the button.
4	Whole bed motor button	The whole bed goes up (goes down) smoothly by pressing the button.
5	The leg pad motor button	Angle of leg pad increases (decreases) smoothly by pressing the button.

### 2. Optional configuration (Instruction of Hand Controller 1)

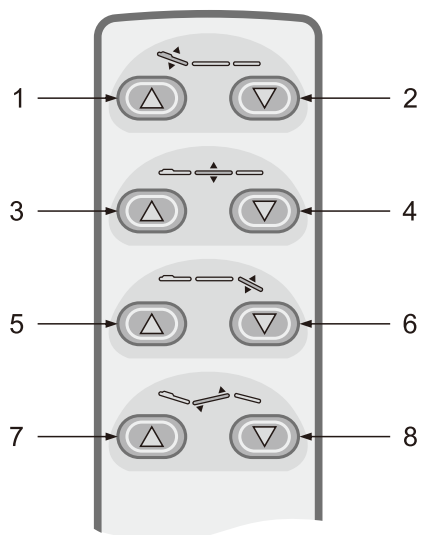

### 3. Optional configuration (Foot Controller)

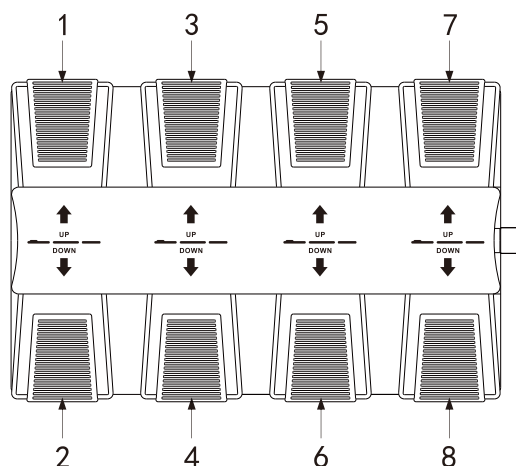

	Description	Operation
1	Backrest motor goes up	Backrest goes up smoothly by pressing the button.
2	Backrest motor goes down	Backrest goes down smoothly by pressing the button.
3	Whole bed motor goes up	The whole bed goes up smoothly by pressing the button.
4	Whole bed motor goes down	The whole bed goes down smoothly by pressing the button.
5	Foot mat angle motor goes up	After pressing the button by foot, the angle of foot mat increases smoothly.
6	Foot mat angle motor goes down	After pressing the button by foot, the angle of footrest decreases smoothly.
7	Cushion angle motor goes up	Angle of cushion increases smoothly by pressing the button.
8	Cushion angle motor goes down	Angle of cushion decreases smoothly by pressing the button.

#### 4. Optional configuration (Instruction of Hand Controller 2)

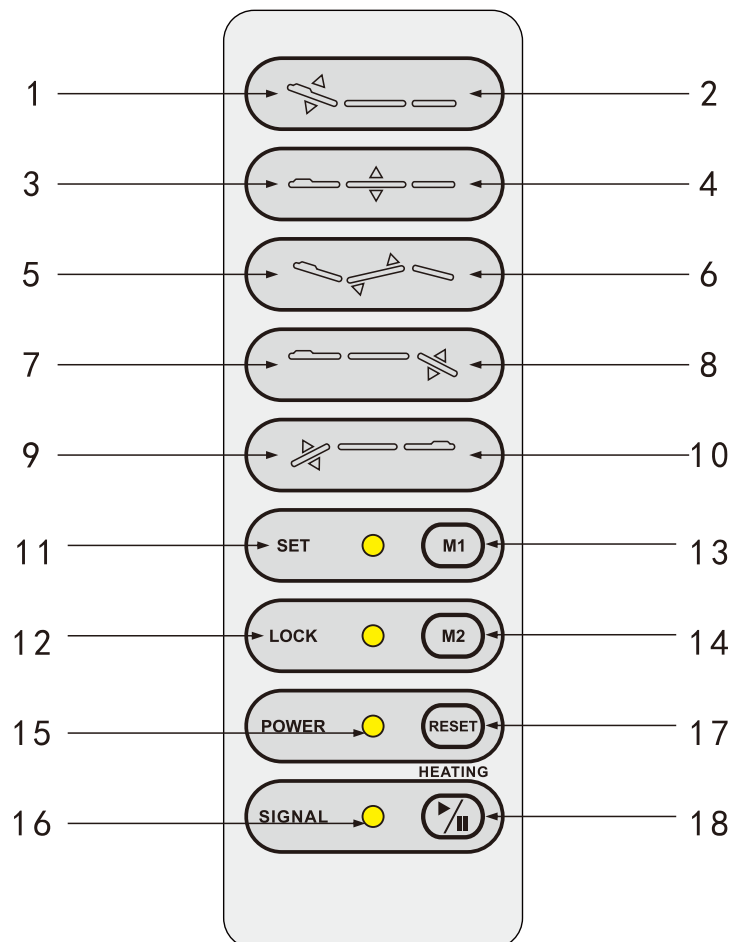

	Description	Operation
1	Backrest motor goes up	Backrest goes up smoothly by pressing the button.
2	Backrest motor goes down	Backrest goes down smoothly by pressing the button.
3	Whole bed motor goes up	The whole bed goes up smoothly by pressing the button.
4	Whole bed motor goes down	The whole bed goes down smoothly by pressing the button.
5	Cushion angle motor goes up	Angle of cushion increases smoothly by pressing the button.
6	Cushion angle motor goes down	Angle of cushion decreases smoothly by pressing the button.
7	The right leg pad motor goes up	Angle of right leg pad increases smoothly by pressing the button.
8	The right leg pad motor goes down	Angle of right leg pad decreases smoothly by pressing the button.
9	The left leg pad motor goes up	Angle of left leg pad increases smoothly by pressing the button.
10	The left leg pad motor goes down	Angle of left leg pad decreases smoothly by pressing the button.
11	Enter the memory location setting	The indicator light is on by pressing the button for 3 seconds, then enter the memory position setting state.
12	Button lock indication	The indicator light is on by pressing the button for 3 seconds, all the buttons are locked; The indicator goes off by long pressing the button for 3 seconds, all the buttons are unlocked.
13	Memory position setting 1	1. After entering the memory position setting state, the memory position setting indicator is on. Setting through the action which you need, and pressing the button, the actions are set into memory. Exiting the memory position setting state and the indicator goes off. 2. Press the button to move to the memory action state automatically
14	Memory position setting 2	1. After entering the memory position setting state, the memory position setting indicator is on. Setting through the action which you need, and pressing the button, the actions are set into memory. Exiting the memory position setting state and the indicator goes off. 2. Press the button to move to the memory action state automatically
15	Power indicator	Hand controller are connected with power supply properly, indicator light is on. Otherwise, it does not light.
16	Heating function indication (optional)	Pressing the button, the heating function works; press the button again, the heating function stops.
17	Motor reset	Press the button, the backrest angle will automatically move to the maximum, the cushion angle will automatically move to the maximum, leg pad angle will automatically reduce to the minimum, the height of the bed will automatically reach the lowest position.
18	Heating (optional)	Pressing the button, the heating function works; press the button again, the heating function stops.

## Notes:

The memory position setting is only available for the models with memory function.

The heating function is only available for the models with heating function.

## 8. Technical Parameters

Product size	1840 (L) × 847 (W) × 590 (880) (H) mm (±10mm)
Package size	1480×720×640mm (±10mm)
The highest position	880±10mm
The lowest position	590±10mm
Angle adjustment of the backrest	0° ~+85° ±2%
Angle adjustment of the seat cushion	0° ~+12° ±2%
Angle adjustment of the footrest	-90° ~ 0° ±2%
Net weight	88 kg
Gross weight	100 kg
Power	AC 220~240V, 50Hz/60Hz
Maximum power	300W
Environment temperature	0°C~+40°C
Relative humidity	30%~90%
Lifting rated load	175 kg

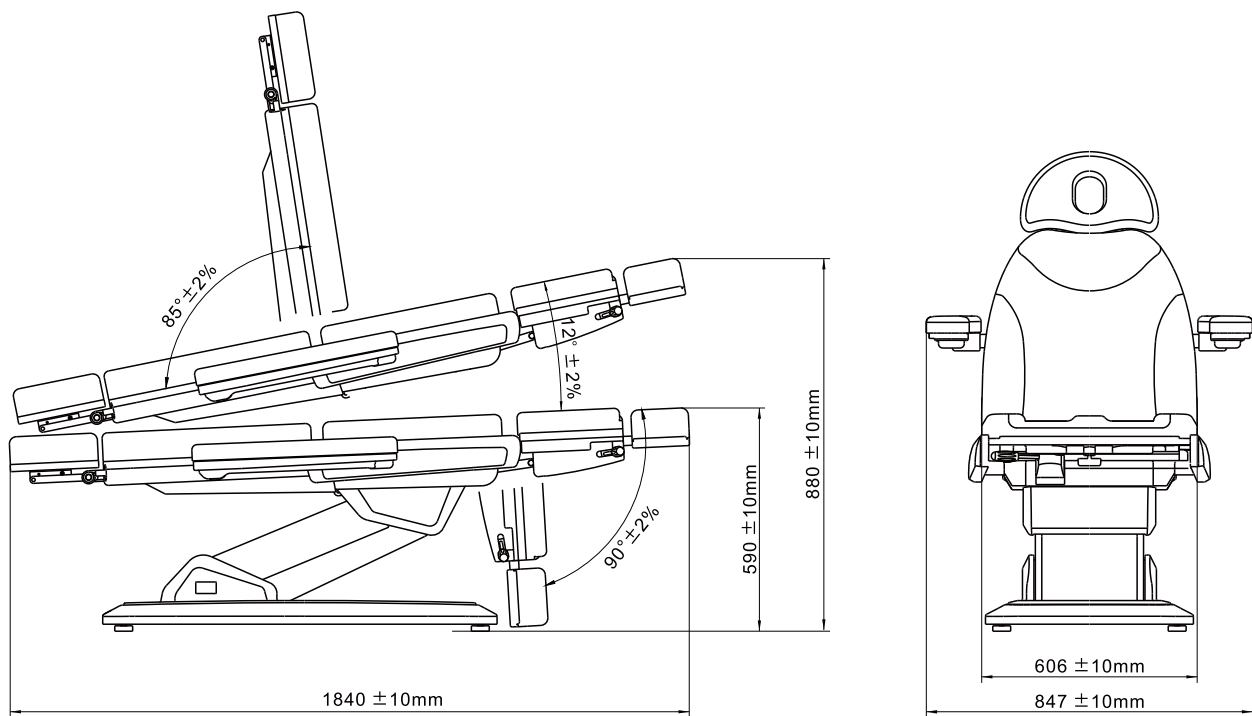



## 9.Maintenance

After every treatment, please use neutral reagent to clear the dust, stains on leather or the plastic cover. This is to prevent premature aging of the leather and plastic cover.

## 10.Circuit system connection diagram

AC 220-240V,50Hz/60Hz

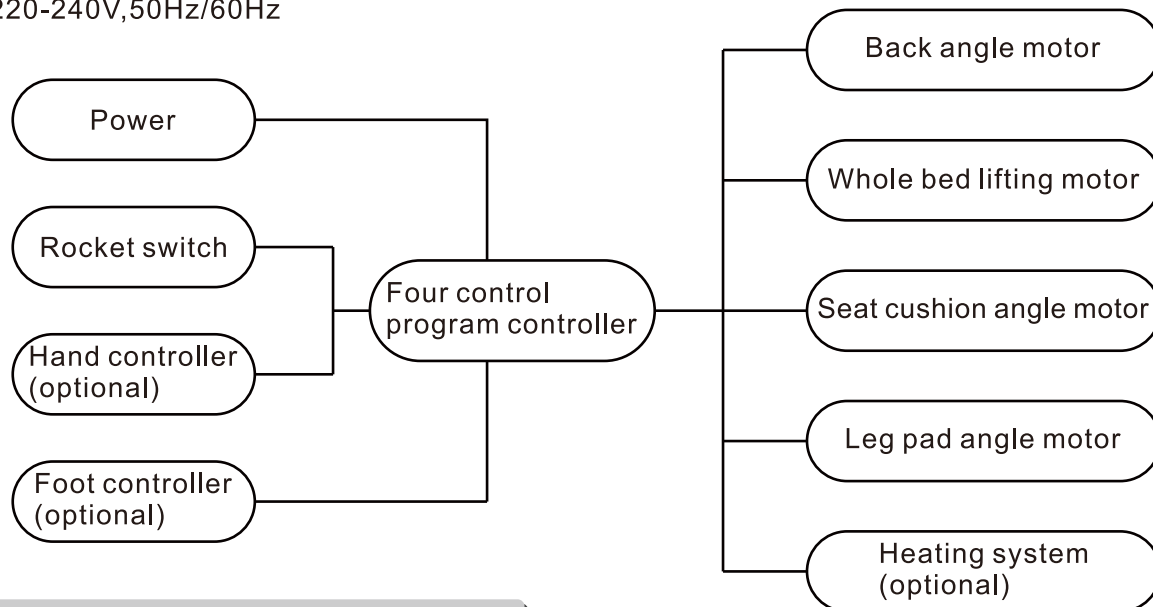

## 11.Troubleshooting

The fault phenomenon	Reason	Solution
Can't go up or down normally	1.The power cord is unconnected or not plugged well	1. Connect the power cord or plug it well
	2. Poor quality of the manual controller	2. Replace the manual control panel
	3. Poor quality of the foot control switch	3, If problem is still not solved after replacing the manual controller or foot control switch, please contact maintenance center or supplier to clear the trouble.
	4. Poor quality of the controller box	
	5. Rupture of motor tail	
	6. Motor detonation	
Abnormal sound	1. The rotating parts lack of lubricating oil	1. Add lubricating oil
	2, Rotating position (such as hinge, P, O, M sets) Lack of lubricating oil	2. Add lubricating oil
	3. Motor quality problems	3. Replace the motor

Please check and verify products specifications before use and this manual is only used for reference. The product specifications will be subject to change or update without further notice.