

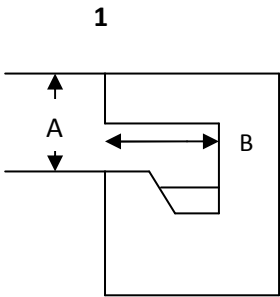

**R-450R**

## DECK CONFIGURATOR ROTATIONAL SERIES LIFTS

PLEASE CHOOSE WHICH APPLICATION YOUR POOL GUTTER BEST REPRESENTS



Fully Recessed Gutter

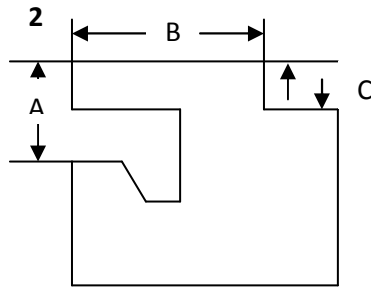

Fully Recessed Gutter  
W/ parapet

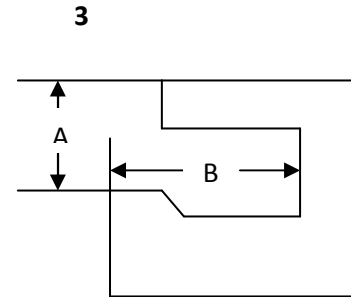

Partially Recessed  
Gutter

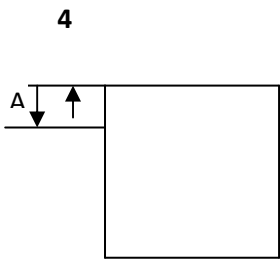

Gutter less Deck

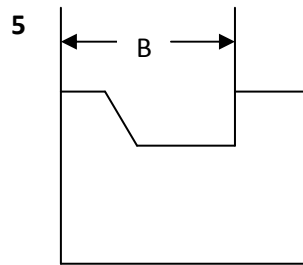

Flush Gutter & Deck  
With or without bull

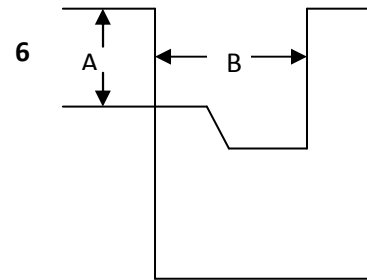

Rollout Gutter

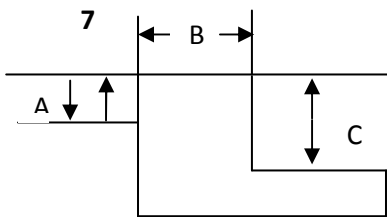

Above Ground Pool

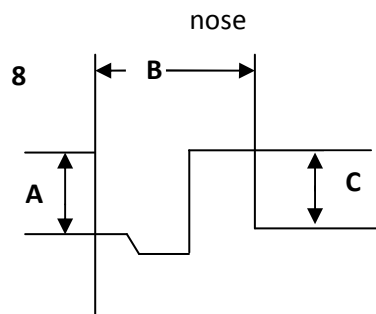

Gutter System with Curb

LEGEND MIN/MAX	
A=	(Draft) pool deck to water line 0 – 9"
B=	Width of Gutter 1 – 35"
C=	Height of Curb 1 – 18"

**NOTE: If your doesn't fall within these measurements,  
Please contact your dealer for assistance.**